



# NEC's 1.0 GHz BANDWIDTH SILICON MMIC AMPLIFIER

## UPC1688G

### FEATURES

- **FLAT GAIN:**  $\Delta GP = \pm 1$  dB TYP from 100 to 700 MHz
- **1000 MHz FREQUENCY RESPONSE AT 3 dB DOWN**
- **21 dB POWER GAIN AT 500 MHz**
- **SINGLE 5 VOLT SUPPLY**
- **NO EXTERNAL BIAS COMPONENTS REQUIRED**
- **LOW COST PACKAGE**
- **50  $\Omega$  GAIN BLOCK**
- **AVAILABLE IN TAPE AND REEL**

NOISE FIGURE AND GAIN vs. FREQUENCY

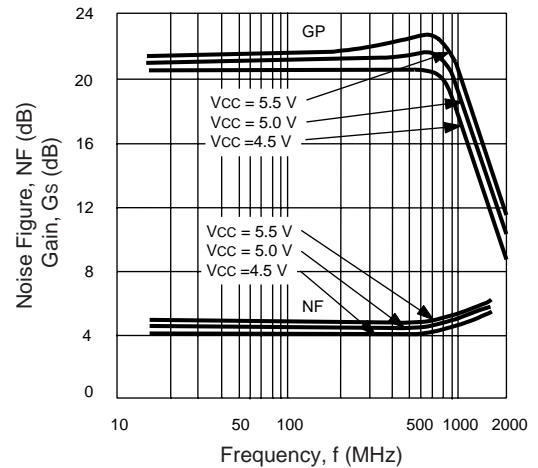

### DESCRIPTION

NEC's UPC1688G is a silicon monolithic integrated circuit specifically designed as a flat gain, wide band amplifier covering the HF through the UHF band. It is particularly suited for low cost high performance amplifier applications.

NEC's stringent quality assurance and test procedures ensure the highest reliability and performance.

### ELECTRICAL CHARACTERISTICS (TA = 25°C, VCC = 5 V, f = 500 MHz, Zs = ZL = 50 $\Omega$ )

PART NUMBER PACKAGE OUTLINE			UPC1688G 39		
SYMBOLS	PARAMETERS AND CONDITIONS	UNITS	MIN	TYP	MAX
I <sub>CC</sub>	Circuit Current	mA	14	19	24
GP	Power Gain	dB	18	21	23
P <sub>SAT</sub>	Saturated Output Power, P <sub>IN</sub> = -5 dBm	dBm	2	4	
NF	Noise Figure	dB		4	5.5
BW	Bandwidth at 3 dB down below the gain at 100 MHz	MHz	900	1100	
ISOL	Isolation	dB	23	27	
RLIN	Input Return Loss	dB	10	13	
RLOUT	Output Return Loss	dB	10	13	

**ABSOLUTE MAXIMUM RATINGS<sup>1</sup>** (T<sub>A</sub> = 25°C)

SYMBOLS	PARAMETERS	UNITS	RATINGS
V <sub>CC</sub>	Supply Voltage	V	6
P <sub>IN</sub>	Input Power	dBm	+10
P <sub>T</sub>	Total Power Dissipation <sup>2</sup>	mW	200
T <sub>OP</sub>	Operating Temperature	°C	-40 to +85
T <sub>STG</sub>	Storage Temperature	°C	-55 to +150

Notes:

1. Operation in excess of any one of these parameters may result in permanent damage.
2. At T<sub>A</sub> = +85°C.

**EQUIVALENT CIRCUIT**

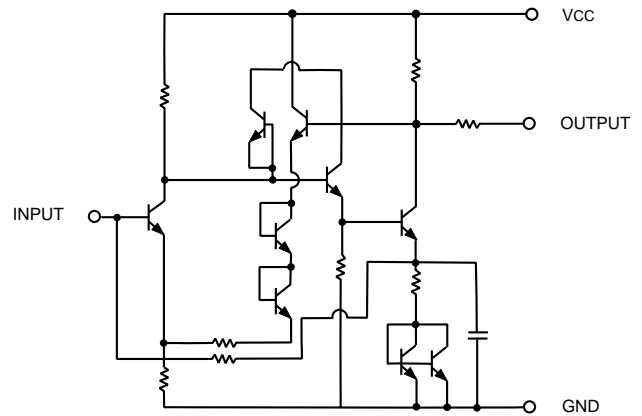

**TYPICAL PERFORMANCE CURVES** (T<sub>A</sub> = 25°C)

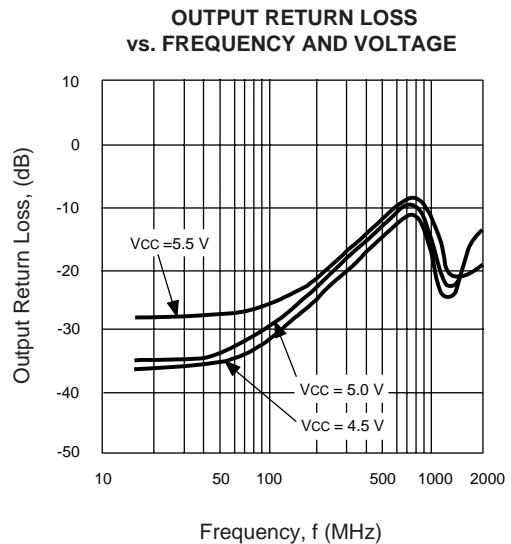
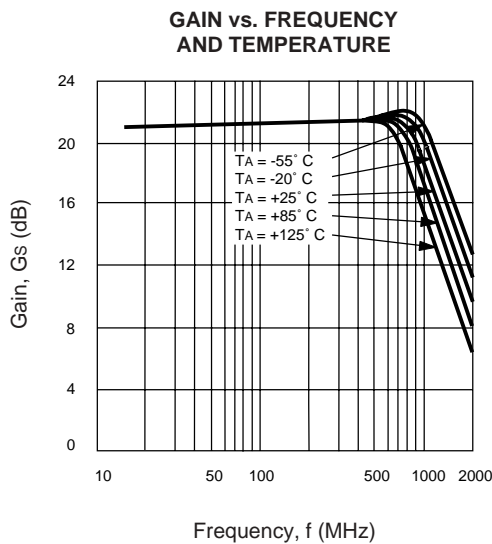
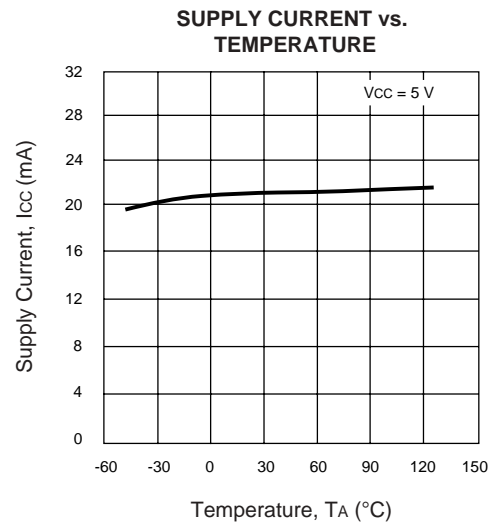
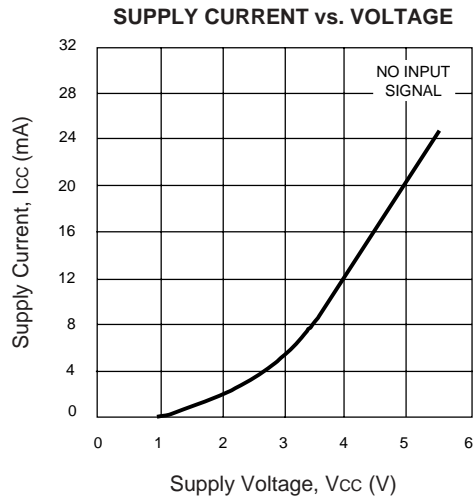

TYPICAL PERFORMANCE CURVES (TA = 25°C)

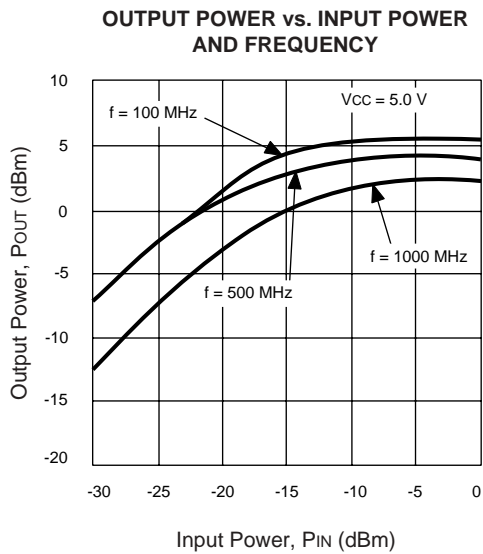
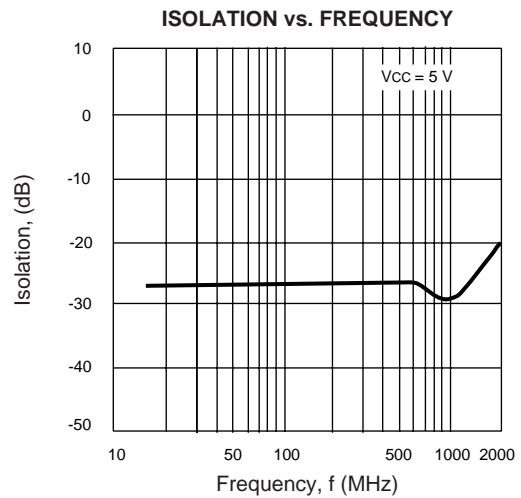
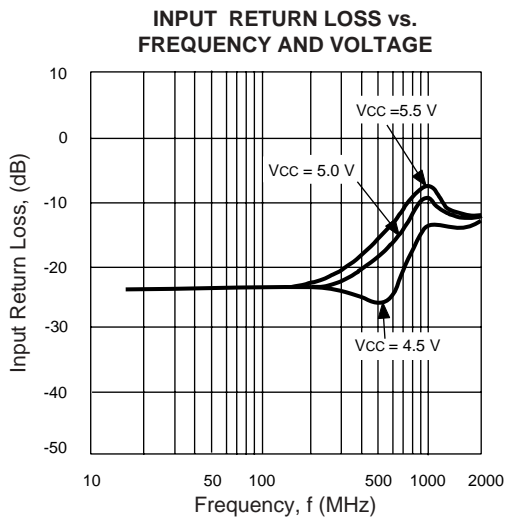
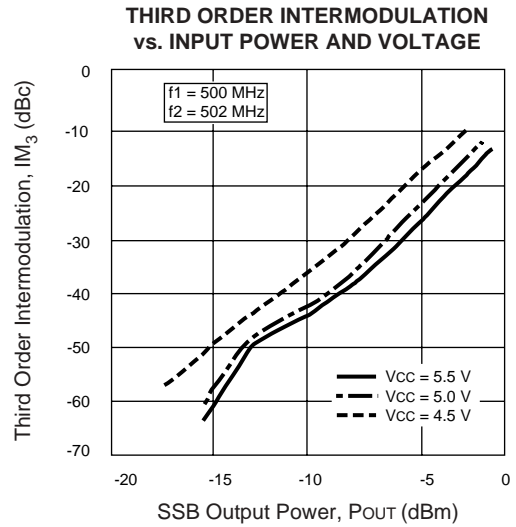
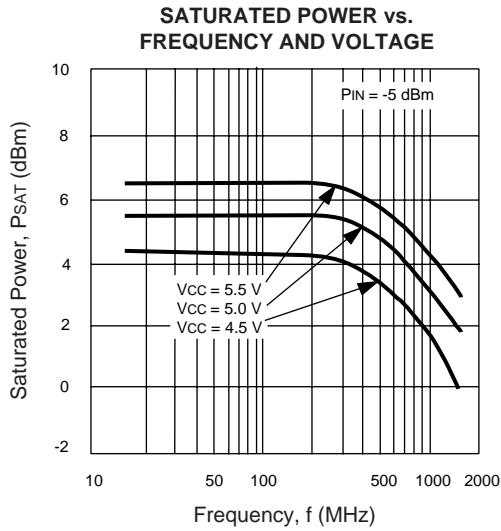

**TYPICAL SCATTERING PARAMETERS** (T<sub>A</sub> = 25°C)

**UPC1688G:**

V<sub>CC</sub> =5.0 V, I<sub>CC</sub> =19 mA

FREQUENCY GHz	S <sub>11</sub>		S <sub>21</sub>		S <sub>12</sub>		S <sub>22</sub>		k	S <sub>21</sub> dB
	MAG	ANG	MAG	ANG	MAG	ANG	MAG	ANG		
0.10	0.102	-85.7	11.040	-13.7	0.042	3.2	0.073	-132.3	1.30	20.9
0.20	0.161	-102.3	11.632	-31.0	0.043	-0.3	0.089	-148.8	1.23	21.3
0.30	0.237	-110.4	12.054	-48.4	0.044	-1.1	0.100	-156.0	1.17	21.6
0.40	0.292	-116.9	12.328	-62.8	0.046	-1.0	0.111	174.0	1.10	21.8
0.50	0.344	-123.9	12.515	-80.8	0.048	8.4	0.136	108.1	1.00	21.9
0.60	0.353	-135.4	12.578	-102.2	0.050	2.2	0.153	47.3	0.94	22.0
0.70	0.348	-152.8	12.466	-124.5	0.053	-1.7	0.172	-16.6	0.93	21.9
0.80	0.301	-165.8	11.899	-148.8	0.055	-7.6	0.192	-37.5	0.96	21.5
0.90	0.217	-175.0	10.564	-172.3	0.057	-11.6	0.222	-60.5	1.02	20.5
1.00	0.113	-169.8	8.983	166.8	0.056	-15.9	0.270	-75.8	1.14	19.1
1.10	0.081	-116.2	7.466	147.5	0.056	-18.3	0.318	-90.6	1.25	17.5
1.20	0.139	-87.2	6.170	130.7	0.053	-19.6	0.350	-102.4	1.45	15.8
1.30	0.219	-82.3	5.177	117.2	0.053	-19.6	0.374	-112.9	1.60	14.3
1.40	0.278	-83.6	4.330	104.5	0.053	-23.2	0.385	-121.6	1.80	12.7
1.50	0.327	-86.8	3.684	93.2	0.054	-24.4	0.390	-129.1	1.97	11.3
1.60	0.366	-89.6	3.161	82.5	0.055	-24.2	0.387	-135.1	2.17	10.0
1.70	0.399	-91.6	2.742	73.3	0.055	-27.2	0.380	-141.0	2.44	8.8
1.80	0.436	-94.8	2.423	64.1	0.056	-28.3	0.371	-145.9	2.62	7.7
1.90	0.452	-96.7	2.178	56.3	0.057	-29.0	0.352	-149.8	2.86	6.8
2.00	0.465	-99.0	1.991	47.7	0.058	-30.4	0.339	-153.0	3.06	6.0
2.10	0.486	-99.3	1.814	39.4	0.059	-28.4	0.319	-155.3	3.27	5.2

**OUTLINE DIMENSIONS** (Units in mm)

**UPC1688G  
PACKAGE OUTLINE 39  
(SOT-143)**

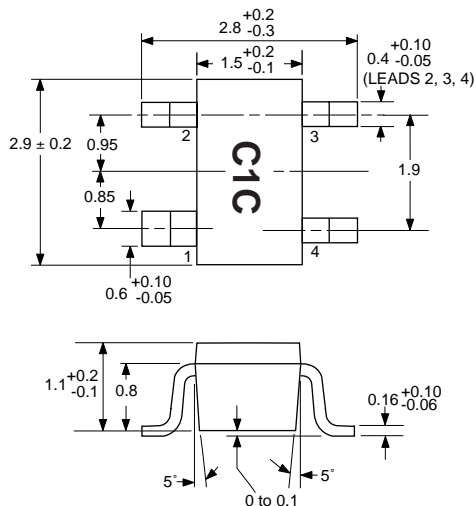

- PIN CONFIGURATIONS**
1. GND
  2. OUTPUT
  3. V<sub>CC</sub>
  4. INPUT

Note:  
All dimensions are typical unless otherwise specified.

**Life Support Applications**

These NEC products are not intended for use in life support devices, appliances, or systems where the malfunction of these products can reasonably be expected to result in personal injury. The customers of CEL using or selling these products for use in such applications do so at their own risk and agree to fully indemnify CEL for all damages resulting from such improper use or sale.

**CEL California Eastern Laboratories**, Your source for NEC RF, Microwave, Optoelectronic, and Fiber Optic Semiconductor Devices.  
4590 Patrick Henry Drive • Santa Clara, CA 95054-1817 • (408) 988-3500 • FAX (408) 988-0279 • [www.cel.com](http://www.cel.com)

DATA SUBJECT TO CHANGE WITHOUT NOTICE

07/01/2004

**ORDERING INFORMATION**

PART NUMBER	QTY
UPC1688G-TI	3000/REEL