

TOSHIBA BIPOLAR LINEAR INTEGRATED CIRCUIT SILICON MONOLITHIC

# TA1211N

## Bi-SCANABLE RGB PROCESSOR

TA1211N is the RGB processing IC coping with bi-scan system. This IC converts Y/I/Q or Y/U/V signals to R/G/B. To cope with bi-scan, this IC has wide Y band. And there are R-Y/G-Y/B-Y output to adjust relative phase and amplitude flexibly.

TA1211N has an I<sup>2</sup>C bus interface, so many functions and features can be controlled via bus lines (SDA/SCL).

### FEATURES

#### Video stage

- High Performance Y Frequency Response
- Black Expansion
- $\gamma$  Correction
- External Quadratic Differential Input for Sharpness
- White Peak Suppressor

#### Chroma stage

- IQ/UV Switching
- Color Limiter
- Flesh Color
- Color  $\gamma$  Correction
- High-Bright Color
- Relative Phase/Amplitude Flexibility

#### Text stage

- Analog RGB Inputs
- Analog RGB Brightness
- Analog RGB Contrast
- Digital OSD Inputs
- Fast Blanking
- Half Tone
- RGB Cut Off Adjustable
- GB Drive Gain Adjustable
- Monitor Output

#### Others

- Y Clamp Circuit
- ACC Circuit
- 3 DAC (1bit) Outputs

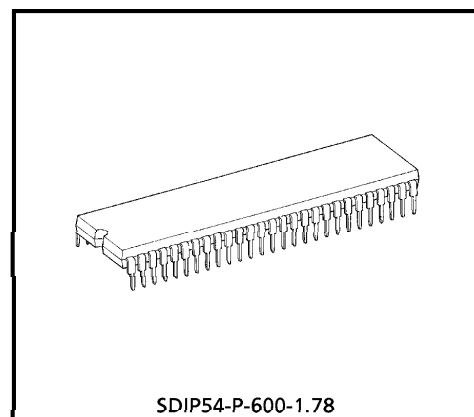

SDIP54-P-600-1.78

Weight : 5.44g (Typ.)

961001EBA2

● TOSHIBA is continually working to improve the quality and the reliability of its products. Nevertheless, semiconductor devices in general can malfunction or fail due to their inherent electrical sensitivity and vulnerability to physical stress. It is the responsibility of the buyer, when utilizing TOSHIBA products, to observe standards of safety, and to avoid situations in which a malfunction or failure of a TOSHIBA product could cause loss of human life, bodily injury or damage to property. In developing your designs, please ensure that TOSHIBA products are used within specified operating ranges as set forth in the most recent products specifications. Also, please keep in mind the precautions and conditions set forth in the TOSHIBA Semiconductor Reliability Handbook.

TERMINAL CONNECTION DIAGRAM

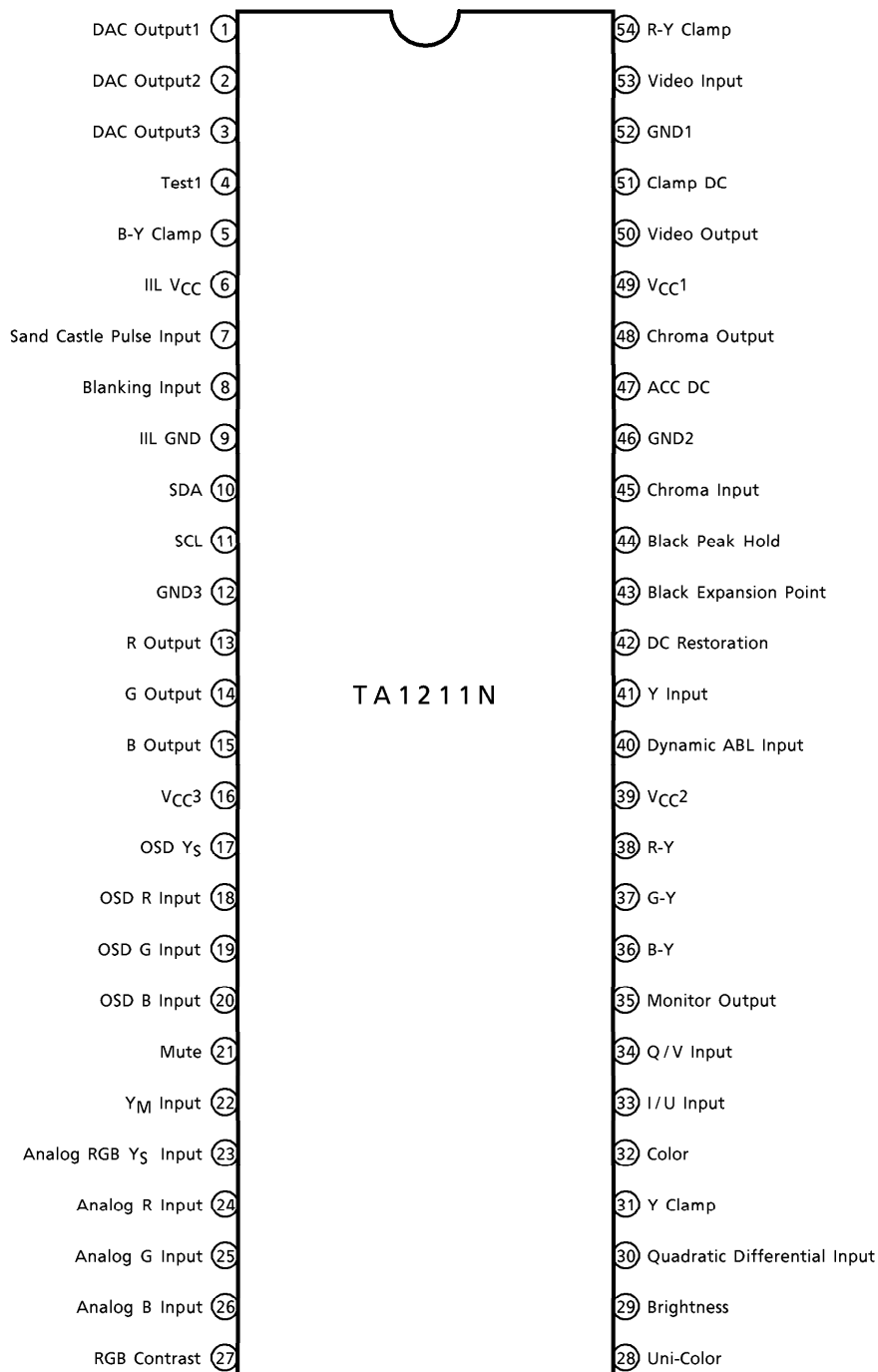

961001EBA2'

- The products described in this document are subject to foreign exchange and foreign trade control laws.
- The information contained herein is presented only as a guide for the applications of our products. No responsibility is assumed by TOSHIBA CORPORATION for any infringements of intellectual property or other rights of the third parties which may result from its use. No license is granted by implication or otherwise under any intellectual property or other rights of TOSHIBA CORPORATION or others.
- The information contained herein is subject to change without notice.



TERMINAL FUNCTION

| PIN No.     | PIN NAME                                  | FUNCTION   | INTERFACE CIRCUIT |
|-------------|---|--|-------------------|
| 1<br>2<br>3 | DAC Output1<br>DAC Output2<br>DAC Output3 | The terminals for 1bit DAC Output. Controlled by I <sup>2</sup> C Bus. When the data is "1", this terminal's voltage is 0V.                          |                   |
| 4           | Test Output1                              | The terminal for test of this IC. Please leave this terminal open.   |                   |
| 5           | B-Y Clamp                                 | The terminals for a filter to clamp B-Y signals. Pedestal levels of R-Y, B-Y and G-Y signal are made equal by the internal clamping circuit.         |                   |
| 6           | I <sup>2</sup> L VCC                      | VCC of I <sup>2</sup> L circuit. Please supply 2.2V to this terminal.  | —                 |
| 7           | Sand Castle Pulse Input                   | The terminal for input of sand castle pulse (Black peak detection pulse + clamp pulse). Threshold level of B.P.D pulse is 2.1V and CLP pulse is 3.5V |                   |

| PIN No.        | PIN NAME                         | FUNCTION   | INTERFACE CIRCUIT |
|----------------|----------------------------------|--|-------------------|
| 8              | Blanking Pulse Input             | The terminal for input of horizontal and vertical blanking pulse. Threshold level of H.BLK pulse is 4.0V and V.BLK pulse is 1.4V.    |                   |
| 9              | I <sup>2</sup> L GND             | Ground of I <sup>2</sup> L circuit.  | —                 |
| 10             | SDA                              | The terminals for input and output of I <sup>2</sup> C Bus data. Input threshold level is 2.3V.                                      |                   |
| 11             | SCL                              | The terminals for input of I <sup>2</sup> C Bus clock. Input threshold level is 2.3V.  |                   |
| 12             | GND3                             | Ground of RGB interface part, color-difference demodulation circuit and Digital / Analog Converter.                                  | —                 |
| 13<br>14<br>15 | R Output<br>G Output<br>B Output | The terminals for output of RGB primary color signals. Horizontal and vertical blanking signals are mixed with RGB signals.          |                   |
| 16             | VCC3                             | VCC of RGB interface part, color-difference demodulation circuit and Digital / Analog Converter. Please supply 12V to this terminal. | —                 |

| PIN No.        | PIN NAME                                  | FUNCTION  | INTERFACE CIRCUIT |
|----------------|---|---|-------------------|
| 17             | OSD Y <sub>S</sub> Input                  | The terminals for input of fast blanking signal for On Screen Display. Threshold level is 1.4V.   |                   |
| 18<br>19<br>20 | OSD R Input<br>OSD G Input<br>OSD B Input | The terminals for input of RGB signals for OSD. Threshold levels are 1.4V. If Terminal 20 is connected with V <sub>CC</sub> , it is test mode for this IC. Threshold level of test mode is V <sub>CC</sub> -0.7V. |                   |
| 21             | Mute                                      | The terminal for input a signal to mute the TV signal and Analog RGB signals. Threshold level of Picture mute (muting TV and Analog RGB) is 2.8V and TV mute (muting only TV) is 1.4V.                            |                   |
| 22             | Y <sub>M</sub> Input                      | The terminal for input a signal to reduce the contrast of TV signal. Threshold level is 1.4V.   |                   |
| 23             | Analog RGB Y <sub>S</sub> Input           | The terminal for input of fast blanking signal for Analog RGB. Threshold level is 1.4V.   |                   |

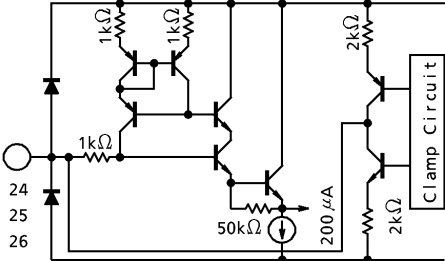
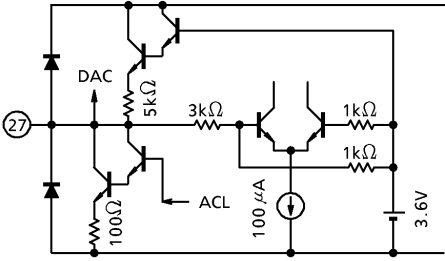
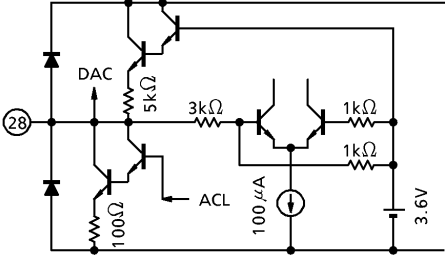
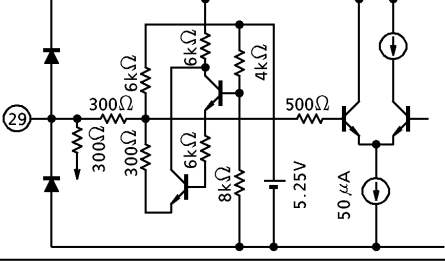
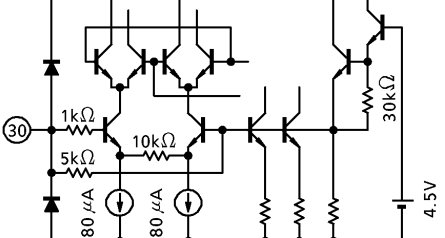
| PIN No.        | PIN NAME   | FUNCTION  | INTERFACE CIRCUIT  |
|----------------|--|---|--|
| 24<br>25<br>26 | Analog R Input<br>Analog G Input<br>Analog B Input | The terminals for input of Analog RGB signals. These are clamped by internal clamping circuit. Recommended input levels are 1.0V <sub>p-p</sub> . |  <p>The diagram shows three input terminals (24, 25, 26) connected to a common clamping circuit. Each input has a 1kΩ resistor. The clamping circuit uses a 50kΩ resistor and a 200 μA current source. A 2kΩ resistor is connected to the clamping node. A separate DAC circuit is shown with a 5kΩ resistor and a 100 μA current source, connected to the DAC output terminal (pin 27).</p> |
| 27             | RGB Contrast                                       | The terminal to control the contrast of Analog RGB signals.   |  <p>The diagram shows the DAC output terminal (pin 27) connected to a DAC circuit. The DAC circuit includes a 5kΩ resistor, a 3kΩ resistor, and a 100 μA current source. The DAC output is connected to the DAC input terminal (pin 28).</p>   |
| 28             | Uni-Color  | The terminal for output of DAC to adjust Uni-Color and also for input of Automatic Contrast Limiter.  |  <p>The diagram shows the DAC output terminal (pin 28) connected to a DAC circuit. The DAC circuit includes a 5kΩ resistor, a 3kΩ resistor, and a 100 μA current source. The DAC output is connected to the DAC input terminal (pin 29).</p>  |
| 29             | Brightness   | The terminal for output of DAC to adjust Brightness and also for input of Automatic Brightness Limiter.   |  <p>The diagram shows the DAC output terminal (pin 29) connected to a DAC circuit. The DAC circuit includes a 5kΩ resistor, a 3kΩ resistor, and a 100 μA current source. The DAC output is connected to the DAC input terminal (pin 30).</p>   |
| 30             | Quadratic Differential Input                       | The terminal for input of quadratic differential signal for sharpness control.  |  <p>The diagram shows the quadratic differential input terminal (pin 30) connected to a DAC circuit. The DAC circuit includes a 5kΩ resistor, a 10kΩ resistor, and a 100 μA current source. The DAC output is connected to the DAC input terminal (pin 31).</p>  |

| PIN No.  | PIN NAME               | FUNCTION   | INTERFACE CIRCUIT |
|----------|------------------------|--|-------------------|
| 31       | Y Clamp                | The terminal for Y clamp filter. Please connect a capacitor between this terminal and GND. 0.01 $\mu$ F is recommended.                    |                   |
| 32       | Color Limiter          | The terminal to fix time constant of Color Limiter. Please connect a capacitor between this terminal and GND. 10 $\mu$ F is recommended.   |                   |
| 33<br>34 | I/U Input<br>Q/V Input | The terminals for I/U and Q/V input. Please input the signals through capacitors because the signals are clamped at the inside of this IC. |                   |
| 35       | Monitor Output         | The terminal to observe Y, R-Y, B-Y and G-Y signals. The signals are selected by I <sup>2</sup> C Bus.                                     |                   |
| 36       | B-Y                    | The terminal for B-Y output to adjust relative phase and amplitude externally.   |                   |



| PIN No. | PIN NAME          | FUNCTION  | INTERFACE CIRCUIT |
|---------|-------------------|---|-------------------|
| 37      | G-Y               | The terminal for G-Y output to adjust relative phase and amplitude externally.  |                   |
| 38      | R-Y               | The terminal for R-Y output to adjust relative phase and amplitude externally.  |                   |
| 39      | VCC2              | VCC of video and sharpness circuit. Please supply 12V to this terminal.   | —                 |
| 40      | Dynamic ABL Input | The terminal to supply control current for Dynamic ABL and Black Peak Level Correction. D.ABL and B.P.L.C. are the functions to shift the level of Y signal toward black side when the most black level is still whitish after black expansion. |                   |
| 41      | Y Input           | The terminal for Y input. Recommended input level is 1.0V <sub>p-p</sub> . Because the pedestal level of Y signal is clamped at this terminal, please reduce the impedance of signal source.  |                   |

| PIN No. | PIN NAME              | FUNCTION   | INTERFACE CIRCUIT |
|---------|-----------------------|--|-------------------|
| 42      | DC Restoration        | The terminal to correct DC restoration ratio. The smaller the external resistance is, the larger the amount of correction is. With this terminal open, you can monitor the Y signal from which sync signal has been removed and which has been done black expansion. |                   |
| 43      | Black Expansion Point | The terminal to fix black expansion start point. The higher voltage is supplied, the higher the start point is.  |                   |
| 44      | Black Peak Hold       | The terminal to control the gain of black expansion and of black level shift for Dynamic ABL. Resistance connected between this terminal and GND makes black expansion change. The smaller the resistance is, the larger the black area is.                          |                   |
| 45      | Chroma Input          | The terminal for chroma input to ACC AMP. Recommended input level is 100mV <sub>p-p</sub> .  |                   |
| 46      | GND2                  | GND of video sharpness circuit.  |                   |
| 47      | ACC DC                | The terminal to fix the gain off ACC AMP. The higher voltage is supplied (0~5V), the larger the gain is.   |                   |

| PIN No. | PIN NAME      | FUNCTION  | INTERFACE CIRCUIT |
|---------|---------------|---|-------------------|
| 48      | Chroma Output | The terminal for output for Chroma which has been input to terminal 45 and has passed ACC AMP.  |                   |
| 49      | VCC1          | VCC of ACC circuit. Please supply 12V to this terminal.   |                   |
| 50      | Video Output  | The terminal for output of Composite Video signal which has been input to terminal 53. This signal is outputted after clamped to the level which is fixed by terminal 51's voltage. |                   |
| 51      | Clamp DC      | The terminal to fix clamping level for Composite Video signal which has been inputted to terminal 53. Please supply 0~5V to this terminal.  |                   |
| 52      | GND1          | GND of ACC circuit.   |                   |
| 53      | Video Input   | The terminal for Composite Video signal input to clamp circuit. Recommended input level is 2V <sub>p-p</sub> .  |                   |

| PIN No. | PIN NAME  | FUNCTION  | INTERFACE CIRCUIT |
|---------|-----------|---|-------------------|
| 54      | R-Y Clamp | The terminals for a filter to clamp R-Y signal. Pedestal levels of R-Y, B-Y and G-Y signal are made equal by the internal clamping circuit. |                   |

**I<sup>2</sup>C BUS MAP**

| SUB ADDRESS | D7                        | D6                    | D5                    | D4           | D3                        | D2         | D1             | D0              | PRESET |      |
|-------------|---------------------------|-----------------------|-----------------------|--------------|---------------------------|------------|----------------|-----------------|--------|------|
| 00          | Picture Mute              | Uni-Color             |                       |              |                           |            |                |                 | 0111   | 1111 |
| 01          | Brightness                |                       |                       |              |                           |            |                |                 | 1000   | 0000 |
| 02          | Color Mute                | Color                 |                       |              |                           |            |                |                 | 0100   | 0000 |
| 03          | Tint                      |                       |                       |              |                           |            |                |                 | 1000   | 0000 |
| 04          | Don't Care                | Sharpness             |                       |              |                           |            |                |                 | / 100  | 0000 |
| 05          | Brightness Linking        | Analog RGB Brightness |                       |              |                           |            |                |                 | 0100   | 0000 |
| 06          | OSD Contrast              | Analog RGB Contrast   |                       |              |                           |            |                |                 | 1100   | 0000 |
| 07          | Don't Care                |                       | Color Limiter Level   |              | Sub Contrast              |            |                | // 11           | 1000   |      |
| 08          | R Cut Off                 |                       |                       |              |                           |            |                |                 | 1000   | 0000 |
| 09          | G Cut Off                 |                       |                       |              |                           |            |                |                 | 1000   | 0000 |
| 0A          | B Cut Off                 |                       |                       |              |                           |            |                |                 | 1000   | 0000 |
| 0B          | IQ/UV Switching           | G Drive               |                       |              |                           |            |                |                 | 0100   | 0000 |
| 0C          | Blue Back ON/OFF          | B Drive               |                       |              |                           |            |                |                 | 0100   | 0000 |
| 0D          | Color $\gamma$ Correction | R-Y Phase             | G-Y Phase             | Flesh ON/OFF | Flesh Pull-in             | Don't Care |                | DAC 1           | 1000   | 1//0 |
| 0E          | Service                   | High-Bright Color     |                       | Don't Care   |                           | DAC 2      | WPS            | Peak ACL ON/OFF | 000/   | /000 |
| 0F          | DAC 3                     | Black Exp. Gain       | Black Detection Level |              | $\gamma$ Correction Point |            | Monitor Output |                 | 0011   | 1100 |

Slave Address : 88H

## CONTENTS OF BUS CONTROL

| ITEM                      | CONTENTS   |                         |                |             | PRESET              |        |
|---------------------------|--|-------------------------|----------------|-------------|---------------------|--------|
| Picture Mute              | 0 : OFF  | 1 : ON                  |                |             | OFF                 |        |
| Uni-Color                 | - 18dB~0dB   |                         |                | (7bit)      | 0dB                 |        |
| Brightness                | - 1.3V~ + 1.3V   | 10mV / STEP             |                | (8bit)      | 0V                  |        |
| Color Mute                | 0 : OFF  | 1 : ON                  |                |             | OFF                 |        |
| Color                     | - 14dB~ + 4dB  |                         |                | (7bit)      | 0dB                 |        |
| Tint                      | - 51.2deg~ + 50.8deg   | 0.4deg / STEP           |                | (8bit)      | 0deg                |        |
| Sharpness                 | - 6dB~ + 12dB  |                         |                | (7bit)      | - 6dB               |        |
| Brightness Linking        | 0 : OFF (RGB Brightness is independent of TV Brightness. )<br>1 : ON (RGB Brightness is linked with TV Brightness. ) |                         |                |             | OFF                 |        |
| RGB Brightness            | - 0.9V~ + 0.9V   |                         |                | (7bit)      | 0V                  |        |
| OSD Contrast              | 0 : 2.5V <sub>p-p</sub>  | 1 : 3.0V <sub>p-p</sub> |                |             | 3.0V <sub>p-p</sub> |        |
| RGB Contrast              | - 18dB~0dB   |                         |                | (7bit)      | - 5dB               |        |
| Color Limiter Level       | 00 : + 1dB   | 01 : 0dB                | 10 : - 1dB     | 11 : OFF    | OFF                 |        |
| Sub Contrast              | - 2dB~ + 2dB   |                         | 0.25dB / STEP  |             | (4bit)              | 0dB    |
| RGB Cut Off               | - 0.3V~ + 0.7V   | Against 3V DC           | 4mV / STEP     |             | (8bit)              | + 0.2V |
| GB Drive                  | - 3dB~ + 3dB   | Against R Gain          |                | (7bit)      | 0dB                 |        |
| IQ→UV Switching           | 0 : ON (Input signals are shifted 33deg. )   |                         |                | 1 : OFF     | ON                  |        |
| Blue Back ON/OFF          | 0 : OFF  | 1 : 1.2V <sub>p-p</sub> |                |             | OFF                 |        |
| Color $\gamma$ Correction | 0 : ON   | 1 : OFF                 |                | on R-Y only | OFF                 |        |
| R-Y Relative Phase        | 0 : 99deg  | 1 : 94deg               |                |             | 94deg               |        |
| G-Y Relative Phase        | 0 : 240deg   | 1 : 236deg              |                |             | 240deg              |        |
| Flesh Color ON/OFF        | 0 : OFF  | 1 : ON                  |                |             | OFF                 |        |
| Flesh Color Pull-in Range | 0 : $\pm 33$ deg   | 1 : $\pm 18$ deg        | Against I Axis |             | $\pm 18$ deg        |        |
| DAC 1 / 2 / 3 Output      | 0 : OPEN   | 1 : ON                  |                |             | OPEN                |        |
| Service Mode              | 0 : OFF 1 : ON (RGB Output Voltage turns to cut off Level. )   |                         |                |             | OFF                 |        |
| High-Bright Color         | 00 : OFF   | 01 : 0.02               | 10 : 0.09      | 11 : 0.12   | OFF                 |        |
| White Peak Slice Level    | 0 : 95IRE  |                         |                | 1 : 105IRE  | 95IRE               |        |
| Peak ACL ON/OFF           | 0 : OFF  | 1 : ON                  |                |             | OFF                 |        |
| Black Expansion Max. Gain | 0 : + 3dB  |                         |                | 1 : OFF     | + 3dB               |        |
| Black Detection Level     | 00 : 0IRE  | 01 : 1.5IRE             | 10 : 2.5IRE    | 11 : 4IRE   | 4IRE                |        |
| $\gamma$ Correction Point | 00 : 80IRE   | 01 : 90IRE              | 10 : 100IRE    | 11 : OFF    | OFF                 |        |
| Monitor Output Switching  | 00 : G-Y   | 01 : R-Y                | 10 : B-Y       | 11 : Y      | G-Y                 |        |

**I<sup>2</sup>C BUS CONTROLLED FORMAT SUMMARY**

Bus controlled format of TA1211N is based of I<sup>2</sup>C Bus control format of Philips.

Data transfer format

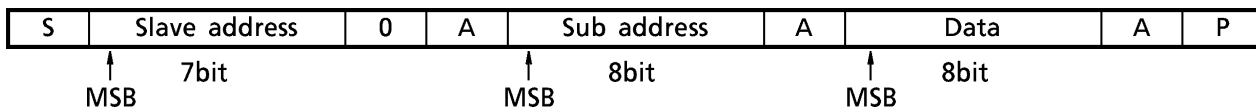

S : Start condition  
 P : Stop condition  
 A : Acknowledge

**(1) Start and stop condition**

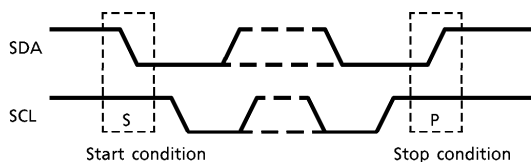

**(2) Bit transfer**

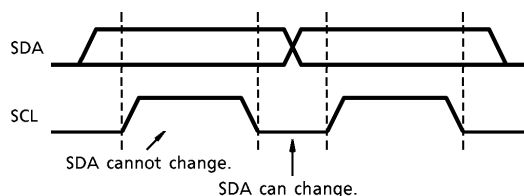

**(3) Acknowledge**

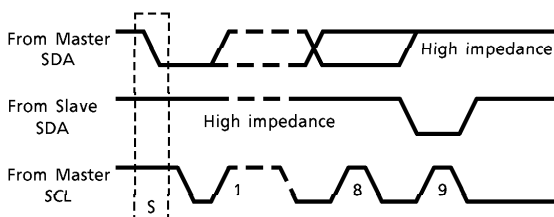

**(4) Slave address**

| A6 | A5 | A4 | A3 | A2 | A1 | A0 | R/ $\bar{W}$ |
|----|----|----|----|----|----|----|--------------|
| 1  | 0  | 0  | 0  | 1  | 0  | 0  | 0            |

Purchase of TOSHIBA I<sup>2</sup>C components conveys a license under the Philips I<sup>2</sup>C Patent Rights to use these components in an I<sup>2</sup>C system, provided that the system conforms to the I<sup>2</sup>C Standard Specification as defined by Philips.

**MAXIMUM RATINGS (Ta = 25°C)**

| CHARACTERISTIC         | SYMBOL            | RATING              | UNIT |
|------------------------|-------------------|---------------------|------|
| Supply Voltage         | V <sub>CC</sub>   | 14.5                | V    |
| Power Dissipation      | P <sub>Dmax</sub> | 1920 (Note)         | mW   |
| Input Treminal Voltage | V <sub>in</sub>   | GND - 0.3~GND + 0.3 | V    |
| Operating Temperature  | T <sub>opr</sub>  | - 20~65             | °C   |
| Storage Temperature    | T <sub>stg</sub>  | - 55~150            | °C   |

(Note) When using this device at above Ta = 25°C, the power dissipation decreases by 15.4mW per 1°C rise.

**Ta - P<sub>D</sub> CURVE**

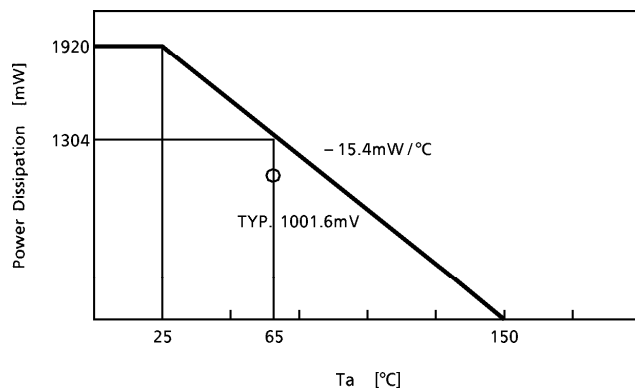



## ELECTRICAL CHARACTERISTICS

## DC CHARACTERISTICS

## Terminal voltage

| PIN No. | PIN NAME                         | SYMBOL          | TEST CIR-CUIT | TEST CONDITION           | MIN. | TYP. | MAX. | UNIT |
|---------|----------------------------------|-----------------|---------------|--------------------------|------|------|------|------|
| 4       | Test1                            | V <sub>4</sub>  | 1             | —                        | 6.15 | 6.65 | 7.15 | V    |
| 5       | B-Y Clamp                        | V <sub>5</sub>  | 1             | —                        | 6.0  | 7.0  | 8.0  | V    |
| 6       | I <sup>2</sup> L V <sub>CC</sub> | V <sub>6</sub>  | 1             | Supply 2.2V              | —    | 2.2  | —    | V    |
| 7       | Sand Castle Pulse Input          | V <sub>7</sub>  | 1             | —                        | 4.3  | 4.6  | 4.9  | V    |
| 9       | I <sup>2</sup> L GND             | V <sub>9</sub>  | 1             | Grounded                 | —    | 0    | —    | V    |
| 12      | GND3                             | V <sub>12</sub> | 1             | Grounded                 | —    | 0    | —    | V    |
| 13      | R Output                         | V <sub>13</sub> | 1             | Cut-off & drive : center | 3.1  | 3.3  | 3.5  | V    |
| 14      | G Output                         | V <sub>14</sub> | 1             | Cut-off & drive : center | 3.1  | 3.3  | 3.5  | V    |
| 15      | B Output                         | V <sub>15</sub> | 1             | Cut-off & drive : center | 3.1  | 3.3  | 3.5  | V    |
| 16      | V <sub>CC3</sub>                 | V <sub>16</sub> | 1             | Supply 12V               | —    | 12   | —    | V    |
| 24      | Analog RGB R Input               | V <sub>24</sub> | 1             | —                        | 3.7  | 4.0  | 4.3  | V    |
| 25      | Analog RGB G Input               | V <sub>25</sub> | 1             | —                        | 3.7  | 4.0  | 4.3  | V    |
| 26      | Analog RGB B Input               | V <sub>26</sub> | 1             | —                        | 3.7  | 4.0  | 4.3  | V    |
| 27      | RGB Contrast                     | V <sub>27</sub> | 1             | —                        | 3.45 | 3.65 | 3.85 | V    |
| 28      | Uni-Color                        | V <sub>28</sub> | 1             | —                        | 3.45 | 3.65 | 3.85 | V    |
| 29      | Brightness                       | V <sub>29</sub> | 1             | —                        | 4.3  | 4.5  | 4.7  | V    |
| 30      | Quadratic Differential Input     | V <sub>30</sub> | 1             | —                        | 2.8  | 3.0  | 3.2  | V    |
| 31      | Y Clamp                          | V <sub>31</sub> | 1             | —                        | 6.5  | 7.5  | 8.5  | V    |
| 32      | Color                            | V <sub>32</sub> | 1             | —                        | 3.45 | 3.65 | 3.85 | V    |
| 33      | I/R-Y Input                      | V <sub>33</sub> | 1             | —                        | 5.9  | 6.1  | 6.3  | V    |
| 34      | Q/B-Y Input                      | V <sub>34</sub> | 1             | —                        | 5.9  | 6.1  | 6.3  | V    |
| 35      | Monitor Output                   | V <sub>35</sub> | 1             | —                        | 4.5  | 4.7  | 4.9  | V    |
| 36      | B-Y Output                       | V <sub>36</sub> | 1             | —                        | 5.15 | 5.30 | 5.45 | V    |
| 37      | G-Y Output                       | V <sub>37</sub> | 1             | —                        | 5.15 | 5.30 | 5.45 | V    |
| 38      | R-Y Output                       | V <sub>38</sub> | 1             | —                        | 5.15 | 5.30 | 5.45 | V    |
| 39      | V <sub>CC2</sub>                 | V <sub>39</sub> | 1             | Supply 12V               | —    | 12   | —    | V    |
| 40      | Dynamic ABL Input                | V <sub>40</sub> | 1             | —                        | 2.1  | 2.6  | 3.1  | V    |
| 41      | Y Input                          | V <sub>41</sub> | 1             | —                        | 4.3  | 4.5  | 4.7  | V    |
| 42      | DC Restoration                   | V <sub>42</sub> | 1             | —                        | 4.1  | 4.3  | 4.5  | V    |
| 43      | Black Expansion Point            | V <sub>43</sub> | 1             | —                        | 4.1  | 4.3  | 4.5  | V    |
| 44      | Black Peak Hold                  | V <sub>44</sub> | 1             | —                        | 3.7  | 4.5  | 5.3  | V    |
| 45      | Chroma Output                    | V <sub>45</sub> | 1             | —                        | 2.3  | 2.6  | 2.9  | V    |
| 46      | GND2                             | V <sub>46</sub> | 1             | Grounded                 | —    | 0    | —    | V    |
| 48      | Chroma Output                    | V <sub>48</sub> | 1             | —                        | 4.05 | 4.20 | 4.35 | V    |
| 49      | V <sub>CC1</sub>                 | V <sub>49</sub> | 1             | Supply 12V               | —    | 12   | —    | V    |
| 50      | Video Output                     | V <sub>50</sub> | 1             | —                        | 2.1  | 2.3  | 2.5  | V    |
| 52      | GND1                             | V <sub>52</sub> | 1             | Grounded                 | —    | 0    | —    | V    |
| 53      | Video Input                      | V <sub>53</sub> | 1             | —                        | 6.15 | 6.35 | 6.55 | V    |
| 54      | R-Y Clamp                        | V <sub>54</sub> | 1             | —                        | 6.0  | 7.0  | 8.0  | V    |

## Current dissipation

| PIN No. | PIN NAME                         | SYMBOL                           | TEST CIR-CUIT | TEST CONDITION | MIN.  | TYP.  | MAX.  | UNIT |
|---------|----------------------------------|----------------------------------|---------------|----------------|-------|-------|-------|------|
| 49      | V <sub>CC1</sub>                 | I <sub>CC1</sub>                 | 1             | —              | 3.92  | 4.90  | 6.13  | mA   |
| 39      | V <sub>CC2</sub>                 | I <sub>CC2</sub>                 | 1             | —              | 14.64 | 18.30 | 22.88 | mA   |
| 16      | V <sub>CC3</sub>                 | I <sub>CC3</sub>                 | 1             | —              | 46.72 | 58.40 | 73.00 | mA   |
| 6       | I <sup>2</sup> L V <sub>CC</sub> | I <sup>2</sup> L I <sub>CC</sub> | 1             | —              | 8.16  | 10.20 | 12.75 | mA   |

## AC CHARACTERISTICS

## Clamp stage

| CHARACTERISTIC                     | SYMBOL                | TEST CIR-CUIT | TEST CONDITION | MIN. | TYP. | MAX. | UNIT             |
|------------------------------------|-----------------------|---------------|----------------|------|------|------|------------------|
| Video Gain                         | G <sub>VIDEO</sub>    | 2             | (Note 1)       | 0.95 | 1.00 | 1.05 | —                |
| Video Frequency Response           | G <sub>FVIDEO</sub>   | 2             | (Note 2)       | —    | -1   | -3   | dB               |
| Dynamic Range of Video In / Output | DR <sub>VIDEO</sub>   | 2             | (Note 3)       | 5.6  | 6.2  | —    | V <sub>p-p</sub> |
|                                    | V <sub>VIDEOMAX</sub> |               |                | 7.0  | 7.4  | —    | V                |
|                                    | V <sub>VIDEOMIN</sub> |               |                | —    | 0.1  | 0.5  | V                |
| Video Clamp Characteristics        | DR <sub>CLP</sub>     | 2             | (Note 4)       | 3.8  | 4.0  | 4.2  | V <sub>p-p</sub> |
|                                    | V <sub>DRCLPCEN</sub> |               |                | 2.35 | 2.40 | 2.55 | V                |
|                                    | V <sub>CLPMAX</sub>   |               |                | 4.4  | 4.6  | 4.8  | V                |
|                                    | V <sub>CLPMIN</sub>   |               |                | 2.1  | 2.3  | 2.5  | V                |
| Drive Current of Video Output      | I <sub>VIDEO</sub>    | 2             | (Note 5)       | 1.2  | 1.5  | 1.8  | mA               |

## ACC stage

| CHARACTERISTIC                      | SYMBOL                 | TEST CIR-CUIT | TEST CONDITION | MIN. | TYP. | MAX. | UNIT             |
|-------------------------------------|------------------------|---------------|----------------|------|------|------|------------------|
| ACC Response                        | G <sub>ACCMAX</sub>    | 2             | (Note 6)       | 24   | 27   | 30   | —                |
|                                     | G <sub>ACCCEN</sub>    |               |                | 10.5 | 12.5 | 15.0 | —                |
|                                     | G <sub>ACCMIN</sub>    |               |                | 0.5  | 0.6  | 0.7  | —                |
| Dynamic Range of Chroma In / Output | DR <sub>CHROMA</sub>   | 2             | (Note 7)       | 1.7  | 1.9  | 2.1  | V <sub>p-p</sub> |
|                                     | V <sub>CHROMAMAX</sub> |               |                | 5.4  | 5.6  | 5.8  | V                |
|                                     | V <sub>CHROMAMIN</sub> |               |                | 2.6  | 2.8  | 3.0  | V                |
| Drive Current of Chroma Output      | I <sub>CHROMA</sub>    | 2             | (Note 8)       | 0.7  | 1.0  | 1.3  | mA               |

## Video stage

| CHARACTERISTIC                                | SYMBOL             | TEST CIR-CUIT | TEST CONDITION | MIN. | TYP. | MAX. | UNIT             |
|---|--------------------|---------------|----------------|------|------|------|------------------|
| Y Input Pedestal Clamp Voltage                | V <sub>YCLP</sub>  | 3             | (Note 9)       | 4.3  | 4.5  | 4.7  | V                |
| Dynamic Range of Y Input                      | DR <sub>YIN</sub>  | 3             | (Note 10)      | 1.0  | 1.2  | 1.4  | V <sub>p-p</sub> |
| Clamp Pulse Phase for Y Input                 | TY <sub>CLP1</sub> | 3             | (Note 11)      | —    | 0.0  | 1.0  | μs               |
|   | TY <sub>CLP2</sub> |               |                | 2.0  | 2.2  | 2.4  | μs               |
| DC Restoration AMP Gain                       | G <sub>DCRES</sub> | 3             | (Note 12)      | 0.28 | 0.34 | 0.40 | —                |
| Max. Sensitivity of Dynamic ABL               | G <sub>DABL</sub>  | 3             | (Note 13)      | 3.5  | 5.0  | 6.5  | mV / μA          |
| Dynamic Range of Quadratic Differential Input | DR <sub>QDIN</sub> | 3             | (Note 14)      | 1.15 | 1.45 | 1.75 | V <sub>p-p</sub> |
| Quadratic Differential Frequency Response     | G <sub>FQD</sub>   | 3             | (Note 15)      | -3.0 | 0.0  | 3.0  | dB               |

| CHARACTERISTIC                             | SYMBOL        | TEST CIR-CUIT | TEST CONDITION | MIN. | TYP. | MAX. | UNIT              |
|--|---------------|---------------|----------------|------|------|------|-------------------|
| Sharpness Control Range                    | GSHPMAX       | 3             | (Note 16)      | 15   | 17   | 19   | dB                |
|  | GSHPCEN       |               |                | 9    | 11   | 13   |                   |
|  | GSHPMIN       |               |                | -9   | -7   | -5   |                   |
| Black Expansion AMP Max. Gain              | GBLEXP        | 3             | (Note 17)      | 1.3  | 1.4  | 1.5  | —                 |
| Black Expansion Start Point                | VBLST1        | 3             | (Note 18)      | 250  | 310  | 370  | mV <sub>p-p</sub> |
|  | VBLST2        |               |                | 340  | 430  | 520  |                   |
| Black Peak Detection Pulse Threshold Level | VBLDETON      | 3             | (Note 19)      | 1.2  | 1.5  | 1.8  | V                 |
| Black Peak Detection Level                 | VBLP1         | 3             | (Note 20)      | -20  | 0    | 20   | mV                |
|  | VBLP2         |               |                | 3    | 11   | 18   |                   |
|  | VBLP3         |               |                | 11   | 18   | 25   |                   |
|  | VBLP4         |               |                | 21   | 28   | 35   |                   |
| $\gamma$ Correction Point                  | V $\gamma$ 00 | 3             | (Note 21)      | 530  | 575  | 620  | mV                |
|  | V $\gamma$ 01 |               |                | 600  | 645  | 690  |                   |
|  | V $\gamma$ 10 |               |                | 670  | 715  | 760  |                   |
| $\gamma$ Correction Curve                  | G $\gamma$    | 3             | (Note 22)      | -2.7 | -2.0 | -1.3 | dB                |
| Blanking Pulse Threshold Level             | VBLKON        | 3             | (Note 23)      | 4.4  | 4.7  | 5.0  | V                 |
| Clamp Pulse Threshold Level                | VCLPON        | 3             | (Note 24)      | 3.2  | 3.5  | 3.8  | V                 |

Chroma stage

| CHARACTERISTIC  | SYMBOL            | TEST CIR-CUIT | TEST CONDITION | MIN. | TYP. | MAX. | UNIT             |
|---|-------------------|---------------|----------------|------|------|------|------------------|
| Color Difference Input Clamp Voltage                      | VRYCL             | 4             | (Note 25)      | 5.9  | 6.1  | 6.3  | V                |
|   | VBYCL             |               |                | 5.9  | 6.1  | 6.3  |                  |
| Color Difference Input Dynamic Range                      | DR <sub>RY</sub>  | 4             | (Note 26)      | 1.0  | 1.2  | —    | V <sub>p-p</sub> |
|   | DR <sub>BY</sub>  |               |                | 1.0  | 1.2  | —    |                  |
| Uni-Color Control Characteristics for Chroma              | VRYUCMAX          | 4             | (Note 27)      | 1.16 | 1.38 | 1.64 | V <sub>p-p</sub> |
|   | VRYUCEN           |               |                | 0.67 | 0.80 | 0.95 | V <sub>p-p</sub> |
|   | VRYUCMIN          |               |                | 0.17 | 0.20 | 0.24 | V <sub>p-p</sub> |
|   | G <sub>RYUC</sub> |               |                | 16.5 | 17.5 | 18.5 | dB               |
|   | VBYCMAX           |               |                | 1.45 | 1.72 | 2.04 | V <sub>p-p</sub> |
|   | VBYCCEN           |               |                | 0.84 | 1.00 | 1.19 | V <sub>p-p</sub> |
|   | VBYCMIN           |               |                | 0.21 | 0.25 | 0.30 | V <sub>p-p</sub> |
|   | G <sub>BYUC</sub> |               |                | 16.5 | 17.5 | 18.5 | dB               |
| Uni-Color Control Characteristics Difference Between Axes | $\Delta$ VUCMAX   | 4             | (Note 28)      | 1.0  | 2.0  | 3.0  | dB               |
|   | $\Delta$ VUCEN    |               |                | 1.0  | 2.0  | 3.0  |                  |
|   | $\Delta$ VUCMIN   |               |                | 1.0  | 2.0  | 3.0  |                  |

| CHARACTERISTIC  | SYMBOL                           | TEST CIR-CUIT | TEST CONDITION | MIN. | TYP. | MAX.  | UNIT             |
|---|----------------------------------|---------------|----------------|------|------|-------|------------------|
| Color Control Characteristics                         | V <sub>RYCOLMAX</sub>            | 4             | (Note 29)      | 1.83 | 2.18 | 2.56  | V <sub>p-p</sub> |
|   | V <sub>RYCOLCEN</sub>            |               |                | 1.16 | 1.38 | 1.64  | V <sub>p-p</sub> |
|   | V <sub>RYCOLMIN</sub>            |               |                | 0.23 | 0.27 | 0.32  | V <sub>p-p</sub> |
|   | G <sub>RYCOLMAX</sub>            |               |                | 3.0  | 4.0  | 5.0   | dB               |
|   | G <sub>RYCOLMIN</sub>            |               |                | -15  | -14  | -13   | dB               |
|   | V <sub>BYCOLMAX</sub>            |               |                | 2.29 | 2.72 | 3.23  | V <sub>p-p</sub> |
|   | V <sub>BYCOLCEN</sub>            |               |                | 1.45 | 1.72 | 2.04  | V <sub>p-p</sub> |
|   | V <sub>BYCOLMIN</sub>            |               |                | 0.29 | 0.34 | 0.40  | V <sub>p-p</sub> |
|   | G <sub>BYCOLMAX</sub>            |               |                | 3    | 4    | 5     | dB               |
|   | G <sub>BYCOLMIN</sub>            |               |                | -15  | -14  | -13   | dB               |
| Color Control Characteristics Difference Between Axes | ΔV <sub>COLMAX</sub>             | 4             | (Note 30)      | 1.0  | 2.0  | 3.0   | dB               |
|   | ΔV <sub>COLCEN</sub>             |               |                | 1.0  | 2.0  | 3.0   |                  |
|   | ΔV <sub>COLMIN</sub>             |               |                | 1.0  | 2.0  | 3.0   |                  |
| Color Control Voltage Variable Range                  | ΔV <sub>32+</sub>                | 4             | (Note 31)      | 0.57 | 0.63 | 0.69  | V                |
|   | ΔV <sub>32-</sub>                |               |                | 0.57 | 0.63 | 0.69  |                  |
| R-Y Relative Phase                                    | Δθ <sub>R99</sub>                | 4             | (Note 32)      | 96.5 | 99.0 | 101.5 | °                |
|   | Δθ <sub>R94</sub>                |               |                | 91.5 | 94.0 | 96.5  | °                |
| R-Y Relative Amplitude                                | V <sub>RY</sub> /V <sub>BY</sub> |               |                | 0.72 | 0.80 | 0.88  | —                |
| G-Y Relative Phase                                    | Δθ <sub>G240</sub>               | 4             | (Note 33)      | 237  | 240  | 243   | °                |
|   | Δθ <sub>G236</sub>               |               |                | 233  | 236  | 239   |                  |
| G-Y Relative Amplitude                                | V <sub>GY</sub> /V <sub>BY</sub> |               |                | 0.36 | 0.40 | 0.44  | —                |
| Half Tone Characteristics for Color Difference        | G <sub>HTRY</sub>                | 4             | (Note 34)      | 0.47 | 0.50 | 0.53  | —                |
|   | G <sub>HTBY</sub>                |               |                | 0.47 | 0.50 | 0.53  | —                |
| Color Difference Output DC Voltage                    | V <sub>RYDC</sub>                | 4             | (Note 35)      | 4.5  | 4.7  | 4.9   | V                |
|   | V <sub>GYDC</sub>                |               |                | 4.5  | 4.7  | 4.9   |                  |
|   | V <sub>BYDC</sub>                |               |                | 4.5  | 4.7  | 4.9   |                  |
| Color γ Correction Characteristics                    | V <sub>COLγ</sub>                | 4             | (Note 36)      | 0.0  | 0.2  | 0.5   | V <sub>p-p</sub> |
|   | Δγ                               |               |                | 0.51 | 0.64 | 0.77  | —                |
| Color Limiter Characteristics                         | CLT <sub>00</sub>                | 4             | (Note 37)      | 1.1  | 1.4  | 1.7   | V <sub>p-p</sub> |
|   | CLT <sub>01</sub>                |               |                | 1.5  | 1.8  | 2.1   |                  |
|   | CLT <sub>10</sub>                |               |                | 1.8  | 2.1  | 2.4   |                  |
|   | CLT <sub>11</sub>                |               |                | 3.8  | 4.0  | 4.2   |                  |
| Gain of High-Bright Color                             | HBC <sub>00</sub>                | 4             | (Note 38)      | —    | 0.00 | 0.02  | —                |
|   | HBC <sub>01</sub>                |               |                | 0.01 | 0.02 | 0.04  |                  |
|   | HBC <sub>10</sub>                |               |                | 0.07 | 0.09 | 0.11  |                  |
|   | HBC <sub>11</sub>                |               |                | 0.10 | 0.12 | 0.14  |                  |

| CHARACTERISTIC               | SYMBOL              | TEST CIR-CUIT | TEST CONDITION | MIN. | TYP. | MAX. | UNIT |
|------------------------------|---------------------|---------------|----------------|------|------|------|------|
| Tint Control Characteristics | $\theta_{RTINTMAX}$ | 4             | (Note 39)      | 34   | 40   | 46   | °    |
|                              | $\theta_{RTINTMIN}$ |               |                | -46  | -40  | -34  |      |
|                              | $\theta_{BTINTMAX}$ |               |                | 34   | 40   | 46   |      |
|                              | $\theta_{BTINTMIN}$ |               |                | -46  | -40  | -34  |      |
| Flesh Color Characteristics  | $F\alpha_{18}$      | 4             | (Note 40)      | 0.46 | 0.58 | 0.70 | —    |
|                              | $F\alpha_{33}$      |               |                | 0.38 | 0.48 | 0.58 |      |

## Text stage

| CHARACTERISTIC                                  | SYMBOL           | TEST CIR-CUIT | TEST CONDITION | MIN. | TYP. | MAX. | UNIT      |
|---|------------------|---------------|----------------|------|------|------|-----------|
| AC Gain   | $G_R$            | 5             | (Note 41)      | 3.5  | 4.0  | 4.6  | —         |
| RGB Frequency Response                          | $G_{FR}$         | 5             | (Note 42)      | 0.0  | -1.0 | -2.5 | dB        |
| Uni-Color Control Characteristics for Luminance | $V_{YUCMAX}$     | 5             | (Note 43)      | 1.11 | 1.26 | 1.41 | $V_{p-p}$ |
|   | $V_{YUCEN}$      |               |                | 0.64 | 0.73 | 0.82 | $V_{p-p}$ |
|   | $V_{YUCMIN}$     |               |                | 0.16 | 0.18 | 0.20 | $V_{p-p}$ |
|   | $G_{YUC}$        |               |                | 16.5 | 17.5 | 18.5 | dB        |
| Uni-Color Control Voltage Variable Range        | $\Delta V_{28+}$ | 5             | (Note 44)      | 0.59 | 0.65 | 0.71 | V         |
|   | $\Delta V_{28-}$ |               |                | 0.59 | 0.65 | 0.71 |           |
| Brightness Control Characteristics              | $V_{BRMAX}$      | 5             | (Note 45)      | 5.8  | 6.0  | 6.2  | V         |
|   | $V_{BRcen}$      |               |                | 4.5  | 4.7  | 4.9  |           |
|   | $V_{BRMIN}$      |               |                | 3.2  | 3.4  | 3.6  |           |
| Brightness Sensitivity Per Step                 | $\Delta V_{BR}$  | 5             | (Note 46)      | 9.2  | 10.2 | 11.2 | mV        |
| Brightness Control Voltage Variable Range       | $\Delta V_{29+}$ | 5             | (Note 47)      | 1.30 | 1.45 | 1.60 | V         |
|   | $\Delta V_{29-}$ |               |                | 1.30 | 1.45 | 1.60 |           |
| White Peak Slice Level                          | $V_{WPS0}$       | 5             | (Note 48)      | 5.9  | 6.1  | 6.3  | V         |
|   | $V_{WPS1}$       |               |                | 6.2  | 6.4  | 6.6  |           |
| Black Peak Slice Level                          | $V_{BPS}$        | 5             | (Note 49)      | 2.6  | 2.8  | 3.0  | V         |
| DC Restoration                                  | $V_{DCREST}$     | 5             | (Note 50)      | —    | 0    | 50   | mV        |
| RGB Output Drive Current                        | $I_R$            | 5             | (Note 51)      | 2.8  | 3.7  | 5.0  | mA        |
| Half Tone Characteristics for Luminance         | $G_{HTY}$        | 5             | (Note 52)      | 0.47 | 0.50 | 0.53 | —         |
| Half Tone ON Threshold Voltage                  | $V_{HTON}$       | 5             | (Note 53)      | 1.2  | 1.5  | 1.8  | V         |
| Vertical Blanking Output Level                  | $V_{RVBLK}$      | 5             | (Note 54)      | 0.3  | 0.8  | 1.3  | V         |
| Horizontal Blanking Output Level                | $V_{RHBLK}$      | 5             | (Note 55)      | 0.3  | 0.8  | 1.3  | V         |
| Delay Time of Blanking Pulse                    | $T_{DBLKON}$     | 5             | (Note 56)      | —    | 0.10 | 0.30 | $\mu s$   |
|   | $T_{DBLKOFF}$    |               |                | —    | 0.25 | 0.45 |           |
| Sub-Contrast Variable Range                     | $G_{SCONT+}$     | 5             | (Note 57)      | 1.8  | 2.0  | 2.2  | dB        |
|   | $G_{SCONT-}$     |               |                | -2.4 | -2.2 | -2.0 |           |
| RGB Output Voltage                              | $V_R$            | 5             | (Note 58)      | 3.1  | 3.3  | 3.5  | V         |

| CHARACTERISTIC                                     | SYMBOL               | TEST CIR-CUIT | TEST CONDITION | MIN.  | TYP.  | MAX.  | UNIT      |
|--|----------------------|---------------|----------------|-------|-------|-------|-----------|
| Cut Off Control Variable Range                     | $\Delta V_{RCO+}$    | 5             | (Note 59)      | 0.49  | 0.54  | 0.59  | V         |
|  | $\Delta V_{RCO-}$    |               |                | -0.59 | -0.54 | -0.49 |           |
| Drive Control Variable Range                       | $G_{GDRV+}$          | 5             | (Note 60)      | 3.5   | 4.0   | 4.5   | dB        |
|  | $G_{GDRV-}$          |               |                | -4.5  | -4.0  | -3.5  |           |
| Output Voltage at Mute Mode (Bus Control)          | $V_{RMUTEBUS}$       | 5             | (Note 61)      | 2.5   | 2.7   | 2.9   | V         |
| Output Voltage at Mute Mode (DC Control)           | $V_{RMUTEDC}$        | 5             | (Note 62)      | 2.5   | 2.7   | 2.9   | V         |
| Picture Mute Threshold Voltage                     | $V_{RPICMUTE}$       | 5             | (Note 63)      | 2.4   | 2.7   | 3.0   | V         |
| TV Mute Threshold Voltage                          | $V_{RTVMUTE}$        | 5             | (Note 64)      | 1.2   | 1.5   | 1.8   | V         |
| Output Voltage at Blue Back Mode                   | $V_{RBBS}$           | 5             | (Note 65)      | 2.5   | 2.7   | 2.9   | V         |
|  | $V_{GBBS}$           |               |                | 2.5   | 2.7   | 2.9   |           |
|  | $V_{BBBS}$           |               |                | 4.2   | 4.4   | 4.6   |           |
| Output Voltage at Service Mode                     | $V_{RSER}$           | 5             | (Note 66)      | 3.1   | 3.3   | 3.5   | V         |
| Peak ACL Level                                     | $V_{ACL}$            | 5             | (Note 67)      | 2.8   | 3.0   | 3.2   | V         |
| Analog RGB Gain                                    | $G_{ANAR}$           | 5             | (Note 68)      | 4.5   | 5.1   | 5.7   | —         |
| Analog RGB Frequency Response                      | $G_{FANAR}$          | 5             | (Note 69)      | 0.0   | -2.0  | -4.0  | dB        |
| Analog RGB Input Dynamic Range                     | $DR_{ANAR}$          | 5             | (Note 70)      | 1.0   | 1.5   | —     | $V_{p-p}$ |
| Analog RGB White Peak Slice Level                  | $V_{ANARWPS}$        | 5             | (Note 71)      | 6.80  | 7.00  | 7.25  | V         |
| Analog RGB Black Peak Slice Level                  | $V_{ANARBPS}$        | 5             | (Note 72)      | 2.0   | 2.2   | 2.4   | V         |
| Analog RGB Contrast Control Characteristics        | $V_{ANARCONMAX}$     | 5             | (Note 73)      | 1.36  | 1.53  | 1.72  | $V_{p-p}$ |
|  | $V_{ANARCONCEN}$     |               |                | 0.76  | 0.85  | 0.95  | $V_{p-p}$ |
|  | $V_{ANARCONMIN}$     |               |                | 0.20  | 0.22  | 0.25  | $V_{p-p}$ |
|  | $G_{ANARCON}$        |               |                | 15.8  | 16.8  | 17.8  | dB        |
| Analog RGB Contrast Control Voltage Variable Range | $\Delta V_{27+}$     | 5             | (Note 74)      | 0.59  | 0.65  | 0.71  | V         |
|  | $\Delta V_{27-}$     |               |                | 0.59  | 0.65  | 0.71  |           |
| Analog PGB Brightness Characteristics              | $V_{ANARBRMAX1}$     | 5             | (Note 75)      | 4.3   | 4.5   | 4.7   | V         |
|  | $V_{ANARBRCEN1}$     | 5             |                | 3.4   | 3.6   | 3.8   |           |
|  | $V_{ANARBRMIN1}$     | 5             |                | 2.5   | 2.7   | 2.9   |           |
|  | $V_{ANARBRMAX2}$     | 5             |                | 5.7   | 5.9   | 6.1   |           |
|  | $V_{ANARBRCEN2}$     | 5             |                | 4.4   | 4.6   | 4.8   |           |
|  | $V_{ANARBRMIN2}$     | 5             |                | 3.1   | 3.3   | 3.5   |           |
| Analog PGB Brightness Sensitivity Per Step         | $\Delta V_{ANARBR1}$ | 5             | (Note 76)      | 12.7  | 14.1  | 15.5  | mV        |
|  | $\Delta V_{ANARBR2}$ |               |                | 9.2   | 10.2  | 11.2  |           |
| Analog PGB $\gamma_5$ Threshold Voltage            | $V_{ANARON}$         | 5             | (Note 77)      | 1.2   | 1.5   | 1.8   | V         |

| CHARACTERISTIC                                       | SYMBOL                 | TEST CIR-CUIT | TEST CONDITION | MIN. | TYP. | MAX. | UNIT |
|--|------------------------|---------------|----------------|------|------|------|------|
| Analog RGB Y <sub>S</sub> Propagation Charcteristics | $\tau_{RANARYS}$       | 5             | (Note 78)      | —    | 20   | 100  | ns   |
|  | $t_{PRANARYS}$         |               |                | —    | 20   | 100  |      |
|  | $\Delta t_{PRANAYS}$   |               |                | —    | 0    | 20   |      |
|  | $\tau_{FANARYS}$       |               |                | —    | 10   | 100  |      |
|  | $t_{PFANARYS}$         |               |                | —    | 45   | 100  |      |
|  | $\Delta t_{PFANAYS}$   |               |                | —    | 0    | 20   |      |
| Analog RGB Propagation Charcteristics                | $\tau_{RANAR}$         | 5             | (Note 79)      | —    | 30   | 100  | ns   |
|  | $t_{PRANAR}$           |               |                | —    | 15   | 100  |      |
|  | $\Delta t_{PRANA}$     |               |                | —    | 0    | 20   |      |
|  | $\tau_{FANAR}$         |               |                | —    | 40   | 100  |      |
|  | $t_{PFANAR}$           |               |                | —    | 20   | 100  |      |
|  | $\Delta t_{PFANA}$     |               |                | —    | 0    | 20   |      |
| Crosstalk from TV to Analog RGB                      | CT <sub>TV-ANA</sub>   | 5             | (Note 80)      | —    | - 55 | - 50 | dB   |
| Crosstalk from Analog RGB to TV                      | CT <sub>ANA-TV</sub>   | 5             | (Note 81)      | —    | - 55 | - 50 | dB   |
| Analog RGB Crosstalk Between Axes                    | CT <sub>ANARGB</sub>   | 5             | (Note 82)      | —    | - 55 | - 40 | dB   |
| OSD Y <sub>S</sub> Threshold Voltage                 | V <sub>OSDRON</sub>    | 5             | (Note 83)      | 1.2  | 1.5  | 1.8  | V    |
| OSD RGB Output Low Level                             | V <sub>OSDRLOW</sub>   | 5             | (Note 84)      | 2.5  | 2.7  | 2.9  | V    |
| OSD RGB Output High Level                            | V <sub>OSDRHIGH1</sub> | 5             | (Note 85)      | 5.5  | 5.7  | 5.9  | V    |
|  | V <sub>OSDRHIGH0</sub> | 5             |                | 5.0  | 5.2  | 5.4  | V    |
| OSD RGB Threshold Level                              | V <sub>OSDRTH</sub>    | 5             | (Note 86)      | 1.2  | 1.5  | 1.8  | V    |
| OSD RGB Y <sub>S</sub> Propagation Charcteristics    | $\tau_{ROSDRYS}$       | 5             | (Note 87)      | —    | 15   | 100  | ns   |
|  | $t_{PROSDRYS}$         |               |                | —    | 20   | 100  |      |
|  | $\Delta t_{PROSDYS}$   |               |                | —    | 0    | 20   |      |
|  | $\tau_{FOSDRYS}$       |               |                | —    | 35   | 100  |      |
|  | $t_{PFOSDRYS}$         |               |                | —    | 25   | 100  |      |
|  | $\Delta t_{PFOSDYS}$   |               |                | —    | 0    | 20   |      |
| OSD RGB Propagation Charcteristics                   | $\tau_{ROSDR}$         | 5             | (Note 88)      | —    | 25   | 100  | ns   |
|  | $t_{PROSDR}$           |               |                | —    | 15   | 100  |      |
|  | $\Delta t_{PROSD}$     |               |                | —    | 0    | 20   |      |
|  | $\tau_{FOSDR}$         |               |                | —    | 35   | 100  |      |
|  | $t_{PFOSDR}$           |               |                | —    | 25   | 100  |      |
|  | $\Delta t_{PFOSD}$     |               |                | —    | 0    | 20   |      |

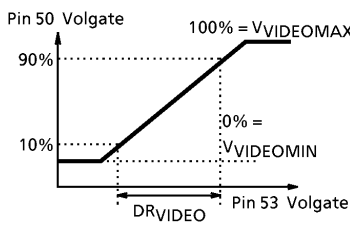
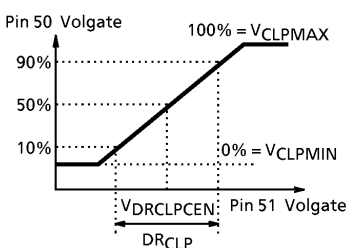

TEST CONDITION  
Clamp stage

| NOTE | CHARACTERISTIC                     | TEST CONDITION ( $V_{CC} = 12V, I^2L V_{CC} = 2.2V, T_a = 25^\circ C$ ) |         |     |     |     | MEASUREMENT MEHOD  |
|------|------------------------------------|---|---------|-----|-----|-----|--|
|      |                                    | TEST CIR-CUIT   | SW MODE |     |     |     |  |
|      |                                    |   | S45     | S47 | S51 | S53 |  |
| 1    | Video Gain                         | 2   | a       | a   | a   | b   | (1) Input a 100kHz, 0.5V <sub>p-p</sub> sine wave into pin 53.<br>(2) Measure the video gain from pin 53 to pin 50 ; $G_{VIDEO}$   |
| 2    | Video Frequency Response           | 2   | a       | a   | a   | b   | (1) Input a 8MHz, 0.5V <sub>p-p</sub> sine wave into pin 53.<br>(2) Measure the video gain from pin 53 to pin 50.<br>(3) Calculate the difference of video gain between for 100kHz input and for 8MHz Input ; $G_{FVIDEO}$                         |
| 3    | Dynamic Range of Video In / Output | 2   | a       | a   | a   | a   | (1) Observe the pin 50's voltage change while varying pin 53's voltage.<br>(2) Measure $DR_{VIDEO}$ , $V_{VIDEOMAX}$ and $V_{VIDEOMIN}$ .<br>                   |
| 4    | Video Clamp Characteristics        | 2   | a       | a   | b   | a   | (1) Observe the pin 50's voltage change while varying pin 51's voltage.<br>(2) Measure $DR_{CLP}$ , $V_{DRCLPCEN}$ , $V_{CLP_{MAX}}$ and $V_{CLP_{MIN}}$ .<br> |
| 5    | Drive Current of Video Output      | 2   | a       | a   | a   | a   | (1) Measure the current flows into pin 50 when this pin is connected 6.0V via 200Ω resistor ; $I_{VIDEO}$  |

ACC stage

| NOTE | CHARACTERISTIC | TEST CONDITION ( $V_{CC} = 12V, I^2L V_{CC} = 2.2V, T_a = 25^\circ C$ ) |         |     |     |     | MEASUREMENT MEHOD   |
|------|----------------|---|---------|-----|-----|-----|---|
|      |                | TEST CIR-CUIT   | SW MODE |     |     |     |   |
|      |                |   | S45     | S47 | S51 | S53 |   |
| 6    | ACC Response   | 2   | b       | b   | a   | a   | (1) Input a 3.58MHz, 50mV <sub>p-p</sub> sine wave into pin 45.<br>(2) Measure the ACC gain from pin 45 to pin 48 when 5.0V is supplied to pin 47 ; $G_{ACC_{MAX}}$<br>(3) Measure the ACC gain when 2.5V is supplied ; $G_{ACC_{CEN}}$<br>(4) Measure the ACC gain when 0V is supplied ; $G_{ACC_{MIN}}$ |

| NOTE | CHARACTERISTIC                    | TEST CONDITION ( $V_{CC} = 12V$ , $I^2L V_{CC} = 2.2V$ , $T_a = 25^\circ C$ ) |         |     |     |     |   |
|------|-----------------------------------|---|---------|-----|-----|-----|---|
|      |                                   | TEST CIR-CUIT   | SW MODE |     |     |     | MEASUREMENT MEHOD   |
|      |                                   |   | S45     | S47 | S51 | S53 |   |
| 7    | Dynamic Range of Chroma In/Output | 2   | b       | b   | a   | a   | (1) Input a 3.58MHz, 50mV <sub>p-p</sub> sine wave into pin 45.<br>(2) Supply 0V to pin 47.<br>(3) While increasing input amplitude, measure the input amplitude at which output signal begins to be clipped ; DR <sub>CHROMA</sub><br>(4) Supply 5.0V to pin 47.<br>(5) While increasing input amplitude, measure the output voltage at which output signal is clipped on its high/low limit ; V <sub>CHROMAMAX</sub> / V <sub>CHROMAMIN</sub> |
| 8    | Drive Current of Chroma Output    | 2   | a       | a   | a   | a   | (1) Measure the current flows into pin 48 when this pin is connected 6.0V via 200Ω resistor ; I <sub>CHROMA</sub>   |

Video stage

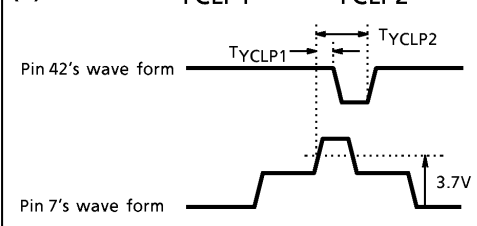
| NOTE | CHARACTERISTIC                 | TEST CONDITION ( $V_{CC} = 12V$ , $I^2L V_{CC} = 2.2V$ , $T_a = 25^\circ C$ ) |         |     |     |     |     |     |     |   |
|------|--------------------------------|---|---------|-----|-----|-----|-----|-----|-----|---|
|      |                                | TEST CIR-CUIT   | SW MODE |     |     |     |     |     |     | MEASUREMENT MEHOD   |
|      |                                |   | S07     | S08 | S20 | S40 | S41 | S43 | S44 |   |
| 9    | Y Input Pedestal Clamp Voltage | 3   | b       | a   | b   | off | a   | off | b   | (1) Measure the pin 41's DC Voltage ; V <sub>YCLP</sub>   |
| 10   | Dynamic Range of Y Input       | 3   | b       | a   | b   | off | a   | off | b   | (1) Uni-Color : Center<br>(2) Monitor Output : Y<br>(3) Supply 4.0V to pin 30.<br>(4) While increasing pin 41's voltage from V <sub>YCLP</sub> , measure the pin 41's voltage at which pin 35's voltage is clipped.<br>(5) Calculate the difference between (4)'s voltage and V <sub>YCLP</sub> ; DR <sub>YIN</sub> |
| 11   | Clamp Pulse Phase for Y Input  | 3   | b       | b   | b   | off | off | off | b   | (1) Connect pin 41 to V <sub>CC</sub> via 20kΩ.<br>(2) Measure T <sub>YCLP1</sub> and T <sub>YCLP2</sub> .<br><br>  |

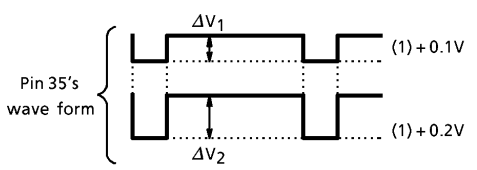
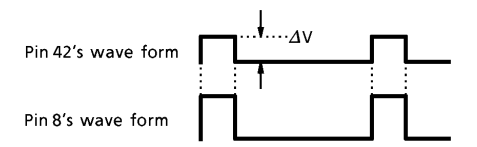
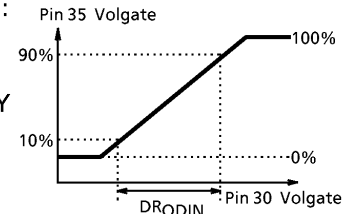
| NOTE | CHARACTERISTIC                                | TEST CONDITION (V <sub>CC</sub> = 12V, I <sup>2</sup> L V <sub>CC</sub> = 2.2V, Ta = 25°C) |         |     |     |     |     |     |     |  |
|------|---|--|---------|-----|-----|-----|-----|-----|-----|--|
|      |   | TEST CIR-CUIT  | SW MODE |     |     |     |     |     |     | MEASUREMENT MEHOD  |
|      |   |  | S07     | S08 | S20 | S40 | S41 | S43 | S44 |  |
| 12   | DC Restoration AMP Gain                       | 3  | b       | a   | b   | off | a   | off | b   | (1) Connect pin 42 to an external power supply and adjust the supply voltage so that pin 42's in / output current is 0A.<br>(2) Monitor Output : Y<br>(3) Set pin 42's voltage to (1)'s voltage +0.1V and +0.2V, then measure $\Delta V_1$ and $\Delta V_2$ .<br><br>(4) Calculate :<br>$G_{DCRES} = (\Delta V_1 - \Delta V_2) / 0.1 / GR$ |
| 13   | Max. Sensitivity of Dynamic ABL               | 3  | b       | a   | b   | a   | a   | off | a   | (1) Black Expansion : OFF<br>(2) Measure $\Delta V$ .<br><br>(3) Calculate : $G_{DABL} = \Delta V / 10$  |
| 14   | Dynamic Range of Quadratic Differential Input | 3  | b       | a   | b   | off | a   | off | b   | (1) Uni-Color : Center<br>(2) Monitor Output : Y<br>(3) Supply 4.35V to pin 41.<br><br>(4) Sharpness : MAX.<br>(5) Measure pin 31's voltage and fix to that voltage by external power supply.<br>(6) Measure the DR <sub>QDIN</sub> .   |
| 15   | Quadratic Differential Frequency Response     | 3  | b       | a   | a   | off | b   | off | b   | (1) Sharpness : MAX.<br>(2) Supply 4.85V to pin 41<br>(3) Input a 100kHz / 8MHz, 0.1Vp-p SIGNAL3 into pin 30,<br>(4) Measure the pin 13's output amplitude and calculate the amplitude ratio between for 100kHz input and for 8MHz input ; GF <sub>OD</sub>  |

| NOTE | CHARACTERISTIC                             | TEST CONDITION ( $V_{CC} = 12V, I^2L V_{CC} = 2.2V, T_a = 25^\circ C$ ) |         |     |     |     |     |     |        | MEASUREMENT MEHOD  |
|------|--|---|---------|-----|-----|-----|-----|-----|--------|--|
|      |  | TEST CIR-CUIT   | SW MODE |     |     |     |     |     |        |  |
|      |  |   | S07     | S08 | S20 | S40 | S41 | S43 | S44    |  |
| 16   | Sharpness Control Range                    | 3   | b       | a   | a   | off | b   | off | b      | (1) Monitor Output : Y<br>(2) Input a 2.4MHz, 0.1V <sub>p-p</sub> sine wave into pin 30.<br>(3) Input a (2)'s signal into pin 41 with reversed phase.<br>(4) Measure the gain between pin 41 and pin 35 with<br>Sharpness MAX. ; G <sub>SHPMAX</sub><br>Sharpness Center ; G <sub>SHPCEN</sub><br>Sharpness MIN. ; G <sub>SHPMIN</sub> |
| 17   | Black Expansion AMP Max. Gain              | 3   | b       | a   | b   | off | b   | off | a      | (1) Black Detection Level : 4IRE<br>(2) Input a 500kHz, 0.1V <sub>p-p</sub> sine wave into pin 41.<br>(3) Supply 4.5V to pin 43.<br>(4) Measure the pin 42's output amplitude with Black Expansion ON and OFF, and calculate the ratio ; G <sub>BLEXP</sub>  |
| 18   | Black Expansion Start Point                | 3   | b       | a   | a   | off | a   | off | b or a | (1) Black Expansion Gain : +3dB<br>(2) While increasing pin 41's voltage from V <sub>YCLP</sub> , observe the change of pin 42's voltage.<br>(3) Measure the V <sub>BLST</sub> when pin 43's voltage is V <sub>YCLP</sub> ; V <sub>BLST1</sub> , and when it is V <sub>YCLP</sub> + 0.5V ; V <sub>BLST2</sub>                          |
| 19   | Black Peak Detection Pulse Threshold Level | 3   | a       | a   | b   | a   | a   | off | c      | (1) Supply 4.0V to pin 41.<br>(2) While increasing pin 7's voltage, measure the pin 7's voltage at which pin 44's voltage changes.   |

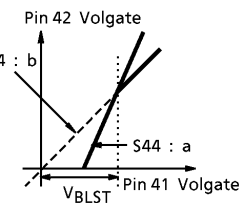

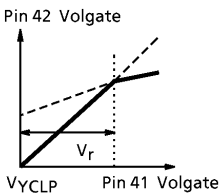
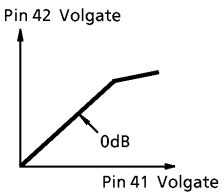
| NOTE | CHARACTERISTIC                 | TEST CONDITION (V <sub>CC</sub> = 12V, I <sup>2</sup> L V <sub>CC</sub> = 2.2V, Ta = 25°C) |         |     |     |     |     |     |                   |   |
|------|--------------------------------|--|---------|-----|-----|-----|-----|-----|-------------------|---|
|      |                                | TEST CIR-CUIT  | SW MODE |     |     |     |     |     | MEASUREMENT MEHOD |   |
|      |                                |  | S07     | S08 | S20 | S40 | S41 | S43 |                   | S44   |
| 20   | Black Peak Detection Level     | 3  | b       | a   | b   | off | a   | off | c                 | (1) Black Expansion Gain : +3dB<br>(2) While increasing pin 41's voltage, measure the pin 41's voltage at which pin 44's voltage changes with<br>Black Detection Level 0IRE ; V <sub>B0</sub><br>Black Detection Level 1.5IRE ; V <sub>B1</sub><br>Black Detection Level 2.5IRE ; V <sub>B2</sub><br>Black Detection Level 4IRE ; V <sub>B3</sub><br>(3) Calculate : V <sub>BLP1</sub> = V <sub>B3</sub> - V <sub>YCLP</sub><br>V <sub>BLP2</sub> = V <sub>B2</sub> - V <sub>B3</sub><br>V <sub>BLP3</sub> = V <sub>B1</sub> - V <sub>B3</sub><br>V <sub>BLP4</sub> = V <sub>B0</sub> - V <sub>B3</sub> |
| 21   | γ Correction Point             | 3  | b       | a   | b   | off | a   | off | b                 | (1) While increasing pin 41's voltage from V <sub>YCLP</sub> , observe the change of pin 42's voltage.  (2) Measure the V <sub>γ</sub> With<br>γ Correction Point 80IRE ; V <sub>γ00</sub><br>γ Correction Point 90IRE ; V <sub>γ01</sub><br>γ Correction Point 100IRE ; V <sub>γ10</sub>   |
| 22   | γ Correction Curve             | 3  | b       | a   | b   | off | a   | off | b                 | (1) Same as Note 21-(1).  (2) Measure the gain with γ Correction ON against the gain with γ Correction OFF, which 0dB ; G <sub>γ</sub>   |
| 23   | Blanking Pulse Threshold Level | 3  | b       | b   | b   | off | a   | off | b                 | (1) Supply 4.0V to pin 41.<br>(2) While increasing pin 8's voltage, measure the pin 8's voltage at which pin 42's voltage changes ; V <sub>BLKON</sub>  |
| 24   | Clamp Pulse Threshold Level    | 3  | a       | b   | b   | off | a   | off | b                 | (1) While increasing pin 7's voltage, measure the pin 7's voltage at which pin 41's voltage turns to V <sub>YCLP</sub> ; V <sub>CPLPON</sub>  |

Chroma stage

| NOTE | CHARACTERISTIC  | TEST CONDITION (V <sub>CC</sub> = 12V, I <sup>2</sup> L V <sub>CC</sub> = 2.2V, Ta = 25°C) |         |     |   |
|------|---|--|---------|-----|---|
|      |   | TEST CIR-CUIT  | SW MODE |     | MEASUREMENT MEHOD   |
|      |   |  | S33     | S34 |   |
| 25   | Color Difference Input Clamp Voltage                      | 4  | a       | a   | (1) Measure the pin 33's voltage ; V <sub>RYCL</sub><br>(2) Measure the pin 34's voltage ; V <sub>BYCL</sub>  |
| 26   | Color Difference Input Dynamic Range                      | 4  | b       | b   | (1) Input a 100kHz, 0.1V <sub>p-p</sub> SIGNAL3 into pin 34.<br>(2) Input a signal whose phase is 90° advanced against SIGNAL3 into pin 33.<br>(3) Color and Uni-Color : MIN.<br>(4) Monitor Output : R-Y<br>(5) While increasing input amplitude, measure the input amplitude at which pin 35's output signal begins to be clipped ; DR <sub>RY</sub><br>(6) Monitor Output : B-Y<br>(7) While increasing input amplitude, measure the input amplitude at which pin 35's output signal begins to be clipped ; DR <sub>BY</sub>   |
| 27   | Uni-Color Control Characteristics for Chroma              | 4  | b       | b   | (1) Input a 100kHz, 0.2V <sub>p-p</sub> SIGNAL3 into pin 34.<br>(2) Input a signal whose phase is 90° advanced against SIGNAL3 into pin 33.<br>(3) Monitor Output : R-Y<br>(4) Measure the pin 35's amplitude with Uni-Color MAX. ; V <sub>RYUCMAX</sub><br>(5) Measure the pin 35's amplitude with Uni-Color Center ; V <sub>RYUCCEN</sub><br>(6) Measure the pin 35's amplitude with Uni-Color MIN. ; V <sub>RYUCMIN</sub><br>(7) Calculate : G <sub>RYUC</sub> = 20log (V <sub>RYUCMAX</sub> / V <sub>RYUCMIN</sub> )<br>(8) Monitor Output : B-Y<br>(9) Repeat (4)~(7) ; V <sub>BYUCMAX</sub> , V <sub>BYUCCEN</sub> , V <sub>BYUCMIN</sub> and G <sub>BYUC</sub> |
| 28   | Uni-Color Control Characteristics Difference Between Axes | 4  | b       | b   | (1) Calculate :<br>$\Delta V_{UCMAX} = 20\log (V_{BYUCMAX} / V_{RYUCMAX})$<br>(2) Calculate : $\Delta V_{UCCEN} = 20\log (V_{BYUCCEN} / V_{RYUCCEN})$<br>(3) Calculate : $\Delta V_{UCMIN} = 20\log (V_{BYUCMIN} / V_{RYUCMIN})$  |

| NOTE | CHARACTERISTIC  | TEST CONDITION (V <sub>CC</sub> = 12V, I <sup>2</sup> L V <sub>CC</sub> = 2.2V, Ta = 25°C) |         |     |  |
|------|---|--|---------|-----|--|
|      |   | TEST CIR-CUIT  | SW MODE |     | MEASUREMENT MEHOD  |
|      |   |  | S33     | S34 |  |
| 29   | Color Control Characteristics                         | 4  | b       | b   | (1) Input a 100kHz, 0.2V <sub>p-p</sub> SIGNAL3 into pin 34.<br>(2) Input a signal whose phase is 90° advanced against SIGNAL3 into pin 33.<br>(3) Monitor Output : R-Y<br>(4) Measure the pin 35's amplitude with Color MAX. ; V <sub>RYCOLMAX</sub><br>(5) Measure the pin 35's amplitude with Color Center ; V <sub>RYCOLCEN</sub><br>(6) Measure the pin 35's amplitude with Color MIN. ; V <sub>RYCOLMIN</sub><br>(7) Calculate :<br>$G_{RYCOLMAX} = 20 \log (V_{RYCOLMAX} / V_{RYCOLCEN})$<br>(8) Calculate :<br>$G_{RYCOLMIN} = 20 \log (V_{RYCOLMIN} / V_{RYCOLCEN})$<br>(9) Monitor Output : B-Y<br>(10) Repeat (4)~(8) ; V <sub>BYCOLMAX</sub> , V <sub>BYCOLCEN</sub> , V <sub>BYCOLMIN</sub> , G <sub>BYCOLMAX</sub> and G <sub>BYCOLMIN</sub> |
| 30   | Color Control Characteristics Difference Between Axes | 4  | b       | b   | (1) Calculate :<br>$\Delta V_{COLMAX} = 20 \log (V_{BYCOLMAX} / V_{RYCOLMAX})$<br>(2) Calculate :<br>$\Delta V_{COLCEN} = 20 \log (V_{BYCOLCEN} / V_{RYCOLCEN})$<br>(3) Calculate :<br>$\Delta V_{COLMIN} = 20 \log (V_{BYCOLMIN} / V_{RYCOLMIN})$   |
| 31   | Color Control Voltage Variable Range                  | 4  | a       | a   | (1) Measure the pin 32's voltage with Color MAX. ; V <sub>32MAX</sub><br>(2) Measure the pin 32's voltage with Color Center ; V <sub>32CEN</sub><br>(3) Measure the pin 32's voltage with Color MIN. ; V <sub>32MIN</sub><br>(4) Calculate : $\Delta V_{32+} = V_{32MAX} - V_{32CEN}$<br>$\Delta V_{32-} = V_{32CEN} - V_{32MIN}$  |
| 32   | R-Y Relative Phase                                    | 4  | b       | b   | (1) Input a 100kHz, 0.2V <sub>p-p</sub> SIGNAL3 into pin 34.<br>(2) Input a signal whose phase is 90° advanced against SIGNAL3 into pin 33.<br>(3) R-Y Relative Phase : 99°<br>(4) Monitor Output : R-Y and B-Y<br>(5) Measure the R-Y Relative Phase against B-Y ; $\Delta \theta R_{99}$<br>(6) R-Y Relative Phase : 94°<br>(7) Repeat (4) and (5) ; $\Delta \theta R_{94}$<br>(8) Measure the R-Y Relative Amplitude against B-Y ; V <sub>RY</sub> / V <sub>BY</sub>  |
|      | R-Y Relative Amplitude                                | 4  |         |     |  |

| NOTE | CHARACTERISTIC                                 | TEST CONDITION ( $V_{CC} = 12V$ , $I^2L V_{CC} = 2.2V$ , $T_a = 25^\circ C$ ) |         |     |   |
|------|--|---|---------|-----|---|
|      |  | TEST CIR-CUIT   | SW MODE |     | MEASUREMENT MEHOD   |
|      |  |   | S33     | S34 |   |
| 33   | G-Y Relative Phase                             | 4   | b       | b   | (1) Input a 100kHz, 0.2V <sub>p-p</sub> SIGNAL3 into pin 34.<br>(2) Input a signal whose phase is 90° advanced against SIGNAL3 into pin 33.<br>(3) G-Y Relative Phase : 240°<br>(4) Monitor Output : G-Y and B-Y<br>(5) Measure the G-Y Relative Phase against B-Y ; $\Delta\theta_{G240}$<br>(6) G-Y Relative Phase : 236°<br>(7) Repeat (4) and (5) ; $\Delta\theta_{G236}$<br>(8) Measure the G-Y Relative Amplitude against B-Y ; $V_{GY}/V_{BY}$ |
|      | G-Y Relative Amplitude                         | 4   |         |     |   |
| 34   | Half Tone Characteristics for Color Difference | 4   | b       | b   | (1) Input a 100kHz, 0.2V <sub>p-p</sub> SIGNAL3 into pin 33.<br>(2) Monitor Output : R-Y<br>(3) Measure the pin 35's output amplitude ; $V_{35RYA}$<br>(4) Supply 5.0V to pin 22.<br>(5) Measure the pin 35's output amplitude ; $V_{35RYB}$<br>(6) Calculate : $G_{HTRY} = V_{35RYB} / V_{35RYA}$<br>(7) Input 100kHz, 0.2V <sub>p-p</sub> SIGNAL3 into pin 34.<br>(8) Monitor Output : B-Y<br>(9) Repeat (3)~(6) ; $G_{HTBY}$                       |
| 35   | Color Difference Output DC Voltage             | 4   | a       | a   | (1) Color Mute : ON<br>(2) Monitor Output : R-Y, and measure the pin 35's DC voltage ; $V_{RYDC}$<br>(3) Monitor Output : G-Y, and measure the pin 35's DC voltage ; $V_{GYDC}$<br>(4) Monitor Output : B-Y, and measure the pin 35's DC voltage ; $V_{BYDC}$   |
| 36   | Color $\gamma$ Correction Characteristics      | 4   | b       | a   | (1) Input a 100kHz, 0.1V <sub>p-p</sub> SIGNAL3 into pin 33.<br>(2) Monitor Output : R-Y<br>(3) While vaying input amplitude, observe the change of pin 35's output amplitude with Color $\gamma$ Correction ON and OFF.<br>(4) Measure the start point ; $V_{COLY}$<br>(5) Assuming that the inclination with OFF is "1", measure the inclination with ON ; $\Delta\gamma$   |
| 37   | Color Limiter Characteristics                  | 4   | a       | b   | (1) Input a 0.3V <sub>p-p</sub> SIGNAL2 into pin 34.<br>(2) Color : MAX.<br>(3) Monitor Output : B-Y<br>(4) Measure the pin 35's output amplitude with Color Limiter Level +1dB, 0dB, -1dB and OFF ; $CLT_{00}$ , $CLT_{01}$ , $CLT_{10}$ and $CLT_{11}$  |

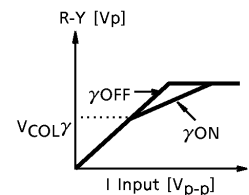



| NOTE | CHARACTERISTIC               | TEST CONDITION ( $V_{CC} = 12V, I^2L V_{CC} = 2.2V, T_a = 25^\circ C$ ) |         |     |  |
|------|------------------------------|---|---------|-----|--|
|      |                              | TEST CIR-CUIT   | SW MODE |     | MEASUREMENT MEHOD  |
|      |                              |   | S33     | S34 |  |
| 38   | Gain of High-Bright Color    | 4   | a       | b   | (1) Input a $0.2V_{p-p}$ SIGNAL2 into pin 34.<br>(2) Monitor Output : B-Y<br>(3) Adjust Color Control so that pin 35's output amplitude turns to $2V_{p-p}$ .<br>(4) Monitor Output : Y<br>(5) Measure the pin 35's output amplitude with High-Bright Color OFF, 0.02, 0.09 and 0.12 ; $V_{3500}$ , $V_{3501}$ , $V_{3510}$ and $V_{3511}$<br>(6) Calculate : $HBC_{00} = V_{3500} / 2$<br>$HBC_{01} = V_{3501} / 2$<br>$HBC_{10} = V_{3510} / 2$<br>$HBC_{11} = V_{3511} / 2$                         |
| 39   | Tint Control Characteristics | 4   | b       | b   | (1) Input a 100kHz, $0.2V_{p-p}$ SIGNAL3 into pin 34.<br>(2) Input a signal whose phase is $90^\circ$ advanced against SIGNAL3 into pin 33.<br>(3) Monitor Output : R-Y<br>(4) Measure the phase shift of pin 35's output between Tint MAX. and Center ; $\theta_{RTINTMAX}$<br>(5) Measure the phase shift of pin 35's output between Tint MIN. and Center ; $\theta_{RTINTMIN}$<br>(6) Monitor Output : B-Y<br>(7) Repeat (4) and (5) ; $\theta_{BTINTMAX}$ and $\theta_{BTINTMIN}$                  |
| 40   | Flesh Color Characteristics  | 4   | b       | b   | (1) Input I/Q signal which is demodulated from Flesh-Bar Signal (its phase is $-30 \sim +240^\circ$ , $15^\circ$ intervals) into pin 33 / 34.<br>(2) Flesh Color Pull-in Range : $\pm 18$ degrees<br>(3) Monitor Output : R-Y and B-Y<br>(4) While observing pin 35's output, measure the color vector response like a right graph.<br>(5) Measure the inclination near I axis with Flesh ON ; $F\alpha_{18}$<br>(6) Flesh Color Pull-in Range : $\pm 33^\circ$<br>(7) Repeat (3)~(5) ; $F\alpha_{33}$ |

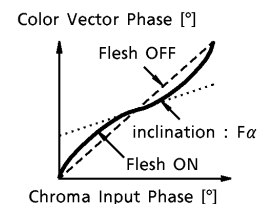

Text stage

| NOTE | CHARACTERISTIC                                  | TEST CONDITION (V <sub>CC</sub> = 12V, I <sup>2</sup> L V <sub>CC</sub> = 2.2V, Ta = 25°C) |         |     |     |     | MEASUREMENT MEHOD   |
|------|---|--|---------|-----|-----|-----|---|
|      |   | TEST CIR-CUIT  | SW MODE |     |     |     |   |
|      |   |  | S24     | S25 | S26 | S41 |   |
| 41   | AC Gain   | 5  | a       | a   | a   | b   | (1) Input a 10kHz, 0.3V <sub>p-p</sub> SIGNAL1 into pin 41.<br>(2) Measure the AC gain from pin 41 to pin 13 ; G <sub>R</sub><br>(3) Green and Blue channels have same spec.  |
| 42   | RGB Frequency Response                          | 5  | a       | a   | a   | b   | (1) Input a 8MHz, 0.3V <sub>p-p</sub> SIGNAL1 into pin 41.<br>(2) Measure the AC gain from pin 41 to pin 13.<br>(3) Calculate the difference of AC gain between for 10kHz input and for 8MHz Input ; G <sub>FR</sub><br>(4) Green and Blue channels have same spec.   |
| 43   | Uni-Color Control Characteristics for Luminance | 5  | a       | a   | a   | b   | (1) Input a 10kHz, 0.3V <sub>p-p</sub> SIGNAL1 into pin 41.<br>(2) Monitor Output : Y<br>(3) Measure the pin 35's output amplitude with Uni-Color MAX., Center and MIN. ; V <sub>YUCMAX</sub> , V <sub>YUCEN</sub> and V <sub>YUCMIN</sub><br>(4) Calculate : $G_{YUC} = 20 \log (V_{YUCMAX} / V_{YUCMIN})$ |
| 44   | Uni-Color Control Voltage Variable Range        | 5  | a       | a   | a   | a   | (1) Measure the pin 28's DC voltage with Uni-Color MAX., Center and MIN. ; V <sub>28MAX</sub> , V <sub>28CEN</sub> and V <sub>28MIN</sub><br>(2) Calculate : $\Delta V_{28+} = V_{28MAX} - V_{28CEN}$<br>$\Delta V_{28-} = V_{28CEN} - V_{28MIN}$   |
| 45   | Brightness Control Characteristics              | 5  | a       | a   | a   | a   | (1) Monitor Output : Y<br>(2) Measure the pin 35's output DC voltage in picture period with Brightness MAX., Center and MIN. ; V <sub>BRMAX</sub> , V <sub>BRcen</sub> and V <sub>BRmin</sub>   |
| 46   | Brightness Sensitivity Per Step                 | 5  | a       | a   | a   | a   | (1) Calculate : $\Delta V_{BR} = (V_{BRMAX} - V_{BRMIN}) / 256$   |
| 47   | Brightness Control Voltage Variable Range       | 5  | a       | a   | a   | a   | (1) Measure the pin 29's DC voltage with Brightness MAX., Center and MIN. V <sub>29MAX</sub> , V <sub>29CEN</sub> and V <sub>29MIN</sub><br>(2) Calculate : $\Delta V_{29+} = V_{29MAX} - V_{29CEN}$<br>$\Delta V_{29-} = V_{29CEN} - V_{29MIN}$  |
| 48   | White Peak Slice Level                          | 5  | a       | a   | a   | a   | (1) Uni-Color, Sub Contrast : MAX.<br>(2) White Peak Slice Level : 95IRE<br>(3) While increasing pin 41's DC voltage, measure the pin 13's output voltage at which the output is clipped ; V <sub>WPS0</sub><br>(4) White Peak Slice Level : 105IRE<br>(5) Repeat (3) ; V <sub>WPS1</sub>                   |

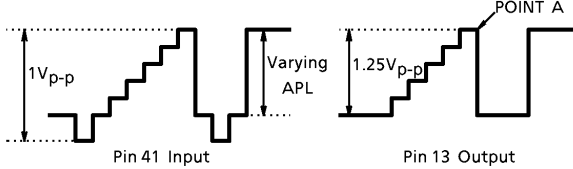
| NOTE | CHARACTERISTIC                          | TEST CONDITION (V <sub>CC</sub> = 12V, I <sup>2</sup> L V <sub>CC</sub> = 2.2V, Ta = 25°C) |         |     |     |     |   |
|------|---|--|---------|-----|-----|-----|---|
|      |   | TEST CIR-CUIT  | SW MODE |     |     |     | MEASUREMENT MEHOD   |
|      |   |  | S24     | S25 | S26 | S41 |   |
| 49   | Black Peak Slice Level                  | 5  | a       | a   | a   | a   | (1) Uni-Color, Sub Contrast : MAX.<br>(2) While decreasing pin 41's DC voltage, measure the pin 13's output voltage at which the output is clipped ; V <sub>BPS</sub>   |
| 50   | DC Restoration                          | 5  | a       | a   | a   | b   | (1) Input a Stair Step Signal into pin 41.<br>(2) Adjust Uni-Color so that the output amplitude turns to 1.25V <sub>p-p</sub><br>(3) While varying input APL from 10% to 90%, measure the change of POINT A's voltage ; V <sub>DCREST</sub><br><br> |
| 51   | RGB Output Drive Current                | 5  | a       | a   | a   | a   | (1) Adjust Brightness so that the pin 13's DC voltage turns to 3.2V in picture period.<br>(2) Connect pin 13 to 4.2V via 100Ω, and measure the current flowing into pin 13 ; I <sub>R</sub><br>(3) Green and Blue channels have same spec.  |
| 52   | Half Tone Characteristics for Luminance | 5  | a       | a   | a   | b   | (1) Input a 100kHz, 0.3V <sub>p-p</sub> SIGNAL1 into pin 41.<br>(2) Measure the pin 13's amplitude in picture period ; V <sub>13A</sub><br>(3) Supply 5.0V to pin 22.<br>(4) Measure the pin 13's amplitude in picture period ; V <sub>13B</sub><br>(5) Calculate : G <sub>HTY</sub> = V <sub>13B</sub> / V <sub>13A</sub>            |
| 53   | Half Tone ON Threshold Voltage          | 5  | a       | a   | a   | b   | (1) Input a 100kHz, 0.3V <sub>p-p</sub> SIGNAL1 into pin 41.<br>(2) Increasing pin 22's voltage from 0V.<br>(3) Measure the pin 22's voltage at which the pin 13's amplitude makes a change ; V <sub>HTON</sub>   |
| 54   | Vertical Blanking Output Level          | 5  | a       | a   | a   | a   | (1) Measure the pin 13's DC voltage in a vertical blanking period ; V <sub>RVBLK</sub><br>(2) Green and Blue channels have same spec.   |
| 55   | Horizontal Blanking Output Level        | 5  | a       | a   | a   | a   | (1) Measure the pin 13's DC voltage in a horizontal blanking period ; V <sub>RHBLK</sub><br>(2) Green and Blue channels have same spec.   |

| NOTE | CHARACTERISTIC                            | TEST CONDITION (V <sub>CC</sub> = 12V, I <sup>2</sup> L V <sub>CC</sub> = 2.2V, Ta = 25°C) |         |     |     |     |   |
|------|---|--|---------|-----|-----|-----|---|
|      |   | TEST CIR-CUIT  | SW MODE |     |     |     | MEASUREMENT MEHOD   |
|      |   |  | S24     | S25 | S26 | S41 |   |
| 56   | Delay Time of Blanking Pulse              | 5  | a       | a   | a   | a   | (1) Input a signal like a below figure into pin 8 and measure the T <sub>DBLKON</sub> and T <sub>DBLKOFF</sub> .<br>  |
| 57   | Sub-Contrast Variable Range               | 5  | a       | a   | a   | a   | (1) Input a 10kHz, 0.3V <sub>p-p</sub> SIGNAL1 into pin 41.<br>(2) Measure the pin 13's amplitude in picture period with Sub Contrast MAX., Center and MIN. ; V <sub>13SCMAX</sub> , V <sub>13SCCEN</sub> and V <sub>13SCMIN</sub><br>(3) Calculate :<br>$G_{SCONT+} = 20\log(V_{13SCMAX}/V_{13SCCEN})$<br>$G_{SCONT-} = 20\log(V_{13SCMIN}/V_{13SCCEN})$                       |
| 58   | RGB Output Voltage                        | 5  | a       | a   | a   | a   | (1) Measure the pin 13's DC voltage in picture period ; V <sub>R</sub><br>(2) Green and Blue channels have same spec.   |
| 59   | Cut Off Control Variable Range            | 5  | a       | a   | a   | a   | (1) Service Mode : ON<br>(2) Measure the pin 13's DC voltage in picture period with R Cut Off MAX., Center and MIN. ; V <sub>RCOMAX</sub> , V <sub>RCOCEN</sub> and V <sub>RCOMIN</sub><br>(3) Calculate : $\Delta V_{RCO+} = V_{RCOMAX} - V_{RCOCEN}$<br>$\Delta V_{RCO-} = V_{RCOMIN} - V_{RCOCEN}$<br>(4) Green and Blue channels have same spec.                            |
| 60   | Drive Control Variable Range              | 5  | a       | a   | a   | b   | (1) Input a 100kHz, 0.3V <sub>p-p</sub> SIGNAL1 into pin 41.<br>(2) Measure the pin 14's amplitude in picture period with G Drive MAX., Center and MIN. ; V <sub>GDRMAX</sub> , V <sub>GDRCEN</sub> and V <sub>GDRMIN</sub><br>(3) Calculate :<br>$G_{GDRV+} = 20\log(V_{GDRMAX}/V_{GDRCEN})$<br>$G_{GDRV-} = 20\log(V_{GDRMIN}/V_{GDRCEN})$<br>(4) Blue channel has same spec. |
| 61   | Output Voltage at Mute Mode (Bus Control) | 5  | a       | a   | a   | a   | (1) Picture Mute : ON<br>(2) Measure the pin 13's DC voltage in picture period ; V <sub>RMUTEBUS</sub><br>(3) Green and Blue channels have same spec.   |

| NOTE | CHARACTERISTIC                           | TEST CONDITION (V <sub>CC</sub> = 12V, I <sup>2</sup> L V <sub>CC</sub> = 2.2V, Ta = 25°C) |         |     |     |     |   |
|------|--|--|---------|-----|-----|-----|---|
|      |  | TEST CIR-CUIT  | SW MODE |     |     |     | MEASUREMENT MEHOD   |
|      |  |  | S24     | S25 | S26 | S41 |   |
| 62   | Output Voltage at Mute Mode (DC Control) | 5  | a       | a   | a   | a   | (1) Supply 5.0V to pin 21.<br>(2) Measure the pin 13's DC voltage in picture period ; V <sub>RMUTEDC</sub><br>(3) Green and Blue channels have same spec.   |
| 63   | Picture Mute Threshold Voltage           | 5  | a       | a   | a   | a   | (1) Analog RGB Brightness : MAX.<br>(2) Supply 5.0V to pin 23.<br>(3) Increasing pin 21's voltage from 0V, measure the pin 21's voltage at which pin 13's voltage makes a change ; V <sub>RPICMUTE</sub><br>(4) Green and Blue channels have same spec.   |
| 64   | TV Mute Threshold Voltage                | 5  | a       | a   | a   | a   | (1) Increasing pin 21's voltage from 0V, measure the pin 21's voltage at which pin 13's voltage makes a change ; V <sub>RTVMUTE</sub><br>(2) Green and Blue channels have same spec.  |
| 65   | Output Voltage at Blue Back Mode         | 5  | a       | a   | a   | a   | (1) Blue Back : ON<br>(2) Measure the pin 13's DC voltage in picture period ; V <sub>RBB</sub><br>(3) Measure the pin 14's DC voltage in picture period ; V <sub>GBB</sub><br>(4) Measure the pin 15's DC voltage in picture period ; V <sub>BBB</sub>    |
| 66   | Output Voltage at Service Mode           | 5  | a       | a   | a   | a   | (1) Service Mode : ON<br>(2) Supply 5.0V to pin 21.<br>(3) Measure the pin 13's DC voltage in picture period ; V <sub>RSER</sub><br>(4) Green and Blue channels have same spec.   |
| 67   | Peak ACL Level                           | 5  | a       | a   | a   | a   | (1) Peak ACL : ON<br>(2) Color : MAX.<br>(3) Switch S34 to b, and input SIGNAL2 into TP34A.<br>(4) While increasing the SIGNAL2's amplitude, measure the pin 15's amplitude in picture period at which pin 28's voltage makes a change ; V <sub>ACL</sub> |

| NOTE | CHARACTERISTIC                    | TEST CONDITION (V <sub>CC</sub> = 12V, I <sup>2</sup> L V <sub>CC</sub> = 2.2V, Ta = 25°C) |         |     |     |     |   |
|------|-----------------------------------|--|---------|-----|-----|-----|---|
|      |                                   | TEST CIR-CUIT  | SW MODE |     |     |     | MEASUREMENT MEHOD   |
|      |                                   |  | S24     | S25 | S26 | S41 |   |
| 68   | Analog RGB Gain                   | 5  | a/c     | a/c | a/c | b   | (1) Input a 10kHz, 0.3V <sub>p-p</sub> SIGNAL1 into pin 41.<br>(2) Adjust G/B Drive so that pin 14's/15's amplitude turn to be equal with pin 13's one.<br>(3) Supply 5.0V to pin 23.<br>(4) Input a 10kHz, 0.3V <sub>p-p</sub> SIGNAL1 into pin 24.<br>(5) Measure the pin 13's amplitude in picture period ; V <sub>ANAR</sub><br>(6) Calculate : G <sub>ANAR</sub> = V <sub>ANAR</sub> / 0.3<br>(7) Green and Blue channels have same spec.                            |
| 69   | Analog RGB Frequency Response     | 5  | a/c     | a/c | a/c | b   | (1) Input a 10kHz, 0.3V <sub>p-p</sub> SIGNAL1 into pin 41.<br>(2) Adjust G/B Drive so that pin 14's/15's amplitude turn to be equal with pin 13's one.<br>(3) Supply 5.0V to pin 23.<br>(4) Input a 8kHz, 0.3V <sub>p-p</sub> SIGNAL1 into pin 24.<br>(5) Measure the pin 13's amplitude in picture period ; V <sub>ANAR8M</sub><br>(6) Calculate : G <sub>FANAR</sub> = 20log (V <sub>ANAR8M</sub> / V <sub>ANAR</sub> )<br>(7) Green and Blue channels have same spec. |
| 70   | Analog RGB Input Dynamic Range    | 5  | a       | a   | a   | a   | (1) Supply 5.0V to pin 23.<br>(2) RGB Contrast : MIN.<br>(3) Input a SIGNAL2 into pin 24.<br>(4) While increasing input amplitude, measure the input amplitude at which pin 13's output signal begins to be clipped ; DR <sub>ANAR</sub><br>(5) Green and Blue channels have same spec.   |
| 71   | Analog RGB White Peak Slice Level | 5  | a       | a   | a   | a   | (1) Input a 10kHz, 0.3V <sub>p-p</sub> SIGNAL1 into pin 41.<br>(2) Adjust G/B Drive so that pin 14's/15's amplitude turn to be equal with pin 13's one.<br>(3) Supply 5.0V to pin 23.<br>(4) RGB Contrast : MAX.<br>(5) While increasing pin 24's DC voltage, measure the pin 13's output voltage at which the output is clipped ; V <sub>ANARWPS</sub><br>(6) Green and Blue channels have same spec.  |

| NOTE | CHARACTERISTIC                                     | TEST CONDITION (V <sub>CC</sub> = 12V, I <sup>2</sup> L V <sub>CC</sub> = 2.2V, Ta = 25°C) |         |     |     |     |   |
|------|--|--|---------|-----|-----|-----|---|
|      |  | TEST CIR-CUIT  | SW MODE |     |     |     | MEASUREMENT MEHOD   |
|      |  |  | S24     | S25 | S26 | S41 |   |
| 72   | Analog RGB Black Peak Slice Level                  | 5  | a       | a   | a   | a   | (1) Input a 10kHz, 0.3V <sub>p-p</sub> SIGNAL1 into pin 41.<br>(2) Adjust G/B Drive so that pin 14's/15's amplitude turn to be equal with pin 13's one.<br>(3) Supply 5.0V to pin 23.<br>(4) RGB Contrast : MAX.<br>(5) While decreasing pin 24's DC voltage, measure the pin 13's output voltage at which the output is clipped ; V <sub>ANARBPS</sub><br>(6) Green and Blue channels have same spec.  |
| 73   | Analog RGB Contrast Control Characteristics        | 5  | a/c     | a/c | a/c | b   | (1) Input a 10kHz, 0.3V <sub>p-p</sub> SIGNAL1 into pin 41.<br>(2) Adjust G/B Drive so that pin 14's/15's amplitude turn to be equal with pin 13's one.<br>(3) Supply 5.0V to pin 23.<br>(4) Input a 100kHz, 0.3V <sub>p-p</sub> SIGNAL1 into pin 24.<br>(5) Measure the pin 13's output amplitude with RGB Contranst MAX., Center and MIN. ; V <sub>ANARCONMAX</sub> , V <sub>ANARCONCEN</sub> and V <sub>ANARCONMIN</sub><br>(6) Calculate : $G_{ANARCON} = 20 \log (V_{ANARCONMAX} / V_{ANARCONMIN})$<br>(7) Green and Blue channels have same spec. |
| 74   | Analog RGB Contrast Control Voltage Variable Range | 5  | a       | a   | a   | a   | (1) Supply 5.0V to pin 23.<br>(2) Measure the pin 27's DC voltage with RGB Contranst MAX., Center and MIN. ; V <sub>27MAX</sub> , V <sub>27CEN</sub> and V <sub>27MIN</sub><br>(3) Calculate : $\Delta V_{27+} = V_{27MAX} - V_{27CEN}$<br>$\Delta V_{27-} = V_{27CEN} - V_{27MIN}$   |

| NOTE | CHARACTERISTIC                              | TEST CONDITION (V <sub>CC</sub> = 12V, I <sup>2</sup> L V <sub>CC</sub> = 2.2V, Ta = 25°C) |         |     |     |     |  |
|------|---|--|---------|-----|-----|-----|--|
|      |   | TEST CIR-CUIT  | SW MODE |     |     |     | MEASUREMENT MEHOD  |
|      |   |  | S24     | S25 | S26 | S41 |  |
| 75   | Analog RGB Brightness Characteristics       | 5  | a       | a   | a   | a   | (1) Input a 10kHz, 0.3V <sub>p-p</sub> SIGNAL1 into pin 41.<br>(2) Adjust G/B Drive so that pin 14's/ 15's amplitude turn to be equal with pin 13's one.<br>(3) Supply 5.0V to pin 23.<br>(4) Input a SIGNAL2 into pin 24.<br>(5) Brightness Linking : OFF<br>(6) Adjust the amplitude of SIGNAL2 so that pin 13's amplitude turns to 0.5V <sub>p-p</sub> in picture period.<br>(7) Measure the pin 13's output DC voltage in picture period with RGB Brightness MAX., Center and MIN. ; V <sub>ANARBRMAX1</sub> , V <sub>ANARBRMIN1</sub> and V <sub>ANARBRMIN1</sub><br>(8) Brightness Linking : ON<br>(9) Adjust the amplitude of SIGNAL2 so that pin 13's amplitude turns to 0.5V <sub>p-p</sub> in picture period.<br>(10) Measure the pin 13's output DC voltage in picture period with Brightness MAX., Center and MIN. ; V <sub>ANARBRMAX2</sub> , V <sub>ANARBRMIN2</sub> and V <sub>ANARBRMIN2</sub><br>(11) Green and Blue channels have same spec. |
| 76   | Analog RGB Brightness Sensitivity Per Step  | 5  | a       | a   | a   | a   | (1) Calculate : $\Delta V_{ANARBR1} = (V_{ANARBRMAX1} - V_{ANARBRMIN1}) / 128$<br>$\Delta V_{ANARBR2} = (V_{ANARBRMAX2} - V_{ANARBRMIN2}) / 256$<br>(2) Green and Blue channels have same spec.  |
| 77   | Analog RGB Y <sub>S</sub> Threshold Voltage | 5  | c       | a   | a   | a   | (1) Input a 10kHz, 0.3V <sub>p-p</sub> SIGNAL1 into pin 24.<br>(2) While increasing pin 23's DC voltage, measure the pin 23's voltage at which SIGNAL1 appears on pin 13 ; V <sub>ANARON</sub><br>(3) Green and Blue channels have same spec.  |



| NOTE | CHARACTERISTIC                                       | TEST CONDITION (V <sub>CC</sub> = 12V, I <sup>2</sup> L V <sub>CC</sub> = 2.2V, Ta = 25°C) |         |     |     |     |  |
|------|--|--|---------|-----|-----|-----|--|
|      |  | TEST CIR-CUIT  | SW MODE |     |     |     | MEASUREMENT MEHOD  |
|      |  |  | S24     | S25 | S26 | S41 |  |
| 78   | Analog RGB Y <sub>s</sub> Propagation Charcteristics | 5  | a       | a   | a   | a   | (1) RGB Brightness : MAX.<br>(2) Input a 3V <sub>p-p</sub> SIGNAL4 into pin 23.<br>(3) According to SIGNAL5, measure the Propagation Characteristics at pin 13 ; τ <sub>RANARYS</sub> , t <sub>PRANARYS</sub> , τ <sub>FANARYS</sub> and t <sub>PFANARYS</sub><br>(4) Green and Blue channels have same spec.<br>(5) Calculate the MAX. difference of raising time and falling time between axes ; Δt <sub>PRANAYS</sub> and Δt <sub>PFANAYS</sub> |
| 79   | Analog RGB Propagation Charcteristics                | 5  | a/c     | a/c | a/c | a   | (1) Supply 5.0V to pin 23.<br>(2) Input a 0.5V <sub>p-p</sub> SIGNAL4 into pin 24.<br>(3) According to SIGNAL5, measure the Propagation Characteristics at pin 13 ; τ <sub>RANAR</sub> , t <sub>PRANAR</sub> , τ <sub>FANAR</sub> and t <sub>PFANAR</sub><br>(4) Green and Blue channels have same spec.<br>(5) Calculate the MAX. difference of raising time and falling time between axes ; Δt <sub>PRANA</sub> and Δt <sub>PFANA</sub>          |
| 80   | Crosstalk from TV to Analog RGB                      | 5  | a       | a   | a   | b   | (1) Input a 4MHz, 0.7V <sub>p-p</sub> SIGNAL1 into pin 41.<br>(2) Adjust Sub Contrast so that the pin 13's amplitude turns to 3.0V <sub>p-p</sub> in picture period.<br>(3) Supply 5.0V to pin 23.<br>(4) Measure the pin 13's amplitude in picture period ; V <sub>13CTA</sub><br>(5) Calculate : CT <sub>TV-ANA</sub> = 20log (V <sub>13CTA</sub> / 3)<br>(6) Green and Blue channels have same spec.  |
| 81   | Crosstalk from Analog RGB to TV                      | 5  | a/b     | a/b | a/b | a   | (1) Supply 5.0V to pin 23.<br>(2) Input a 4MHz, 0.7V <sub>p-p</sub> SIGNAL1 into pin 24.<br>(3) Adjust RGB Contrast so that the pin 13's amplitude turns to 3.0V <sub>p-p</sub> in picture period.<br>(4) Shapness : Center<br>(5) Measure the pin 13's amplitude in picture period ; V <sub>13CTB</sub><br>(6) Calculate : CT <sub>ANA-TV</sub> = 20log (V <sub>13CTB</sub> / 3)<br>(7) Green and Blue channels have same spec.                   |

| NOTE | CHARACTERISTIC                                    | TEST CONDITION (V <sub>CC</sub> = 12V, I <sup>2</sup> L V <sub>CC</sub> = 2.2V, Ta = 25°C) |         |     |     |     |   |
|------|---|--|---------|-----|-----|-----|---|
|      |   | TEST CIR-CUIT  | SW MODE |     |     |     | MEASUREMENT MEHOD   |
|      |   |  | S24     | S25 | S26 | S41 |   |
| 82   | Analog RGB Crosstalk Between Axes                 | 5  | a/b     | a/b | a/b | a   | (1) Supply 5.0V to pin 23.<br>(2) Input a 1MHz, 0.5V <sub>p-p</sub> SIGNAL1 into pin 24.<br>(3) Measure the pin 13's, 14's and pin 15's amplitude in picture period and calculate the Crosstalk between axes.<br>(4) Input a 1MHz, 0.5V <sub>p-p</sub> SIGNAL1 into pin 25/26.<br>(5) Repeat (3) and pick up the MAX. Crosstalk amog all pairs of channels ; CT <sub>ANARGB</sub>   |
| 83   | OSD Y <sub>S</sub> Threshold Voltage              | 5  | a       | a   | a   | a   | (1) While increasing pin 17's DC voltage, measure the pin 17's voltage at which the pin 13's voltage makes a change ; V <sub>OSDRON</sub><br>(2) Green and Blue channels have same spec.  |
| 84   | OSD RGB Output Low Level                          | 5  | a       | a   | a   | a   | (1) Supply 5.0V to pin 17.<br>(2) Measure the pin 13's DC voltage in picture period ; V <sub>OSDRLOW</sub><br>(3) Green and Blue channels have same spec.   |
| 85   | OSD RGB Output High Level                         | 5  | a       | a   | a   | a   | (1) Supply 5.0V to pin 17.<br>(2) Supply 5.0V to pin 18.<br>(3) Measure the pin 13's DC voltage in picture period with OSD Contranst 3.0V <sub>p-p</sub> and 2.5V <sub>p-p</sub> ; V <sub>OSDRHIGH1</sub> and V <sub>OSDRHIGH0</sub>  |
| 86   | OSD RGB Threshold Level                           | 5  | a       | a   | a   | a   | (1) Supply 5.0V to pin 17.<br>(2) While increasing pin 18's DC voltage, measure the pin 18's voltage at which the pin 13's voltage makes a change ; V <sub>OSDRTH</sub><br>(3) Green and Blue channels have same spec.  |
| 87   | OSD RGB Y <sub>S</sub> Propagation Charcteristics | 5  | a       | a   | a   | a   | (1) Input a 3V <sub>p-p</sub> SIGNAL4 into pin 17.<br>(2) According to SIGNAL6, measure the Propagation Characteristics at pin 13 ; τ <sub>ROSDRYs</sub> , t <sub>PROSDRYs</sub> , τ <sub>FOSDRYs</sub> and t <sub>PFOSDRYs</sub><br>(3) Green and Blue channels have same spec.<br>(4) Calculate the MAX. difference of raising time and falling time between axes ; Δt <sub>PROSDRYs</sub> and Δt <sub>PFOSDRYs</sub>                   |
| 88   | OSD RGB Propagation Charcteristics                | 5  | a       | a   | a   | a   | (1) Supply 5.0V to pin 17.<br>(2) Input a 3.0V <sub>p-p</sub> SIGNAL4 into pin 18.<br>(3) According to SIGNAL5, measure the Propagation Characteristics at pin 13 ; τ <sub>ROSDR</sub> , t <sub>PROSDR</sub> , τ <sub>FOSDR</sub> and t <sub>PFOSDR</sub><br>(4) Green and Blue channels have same spec.<br>(5) Calculate the MAX. difference of raising time and falling time between axes ; Δt <sub>PROSD</sub> and Δt <sub>PFOSD</sub> |

**SIGNALS FOR MEASUREMENT**

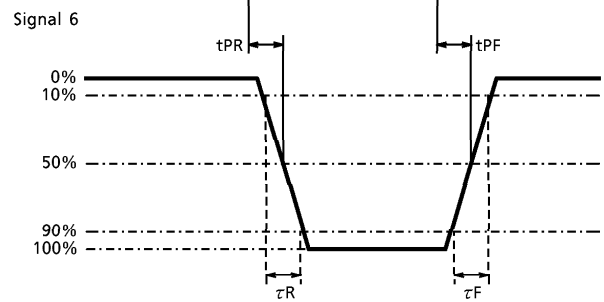
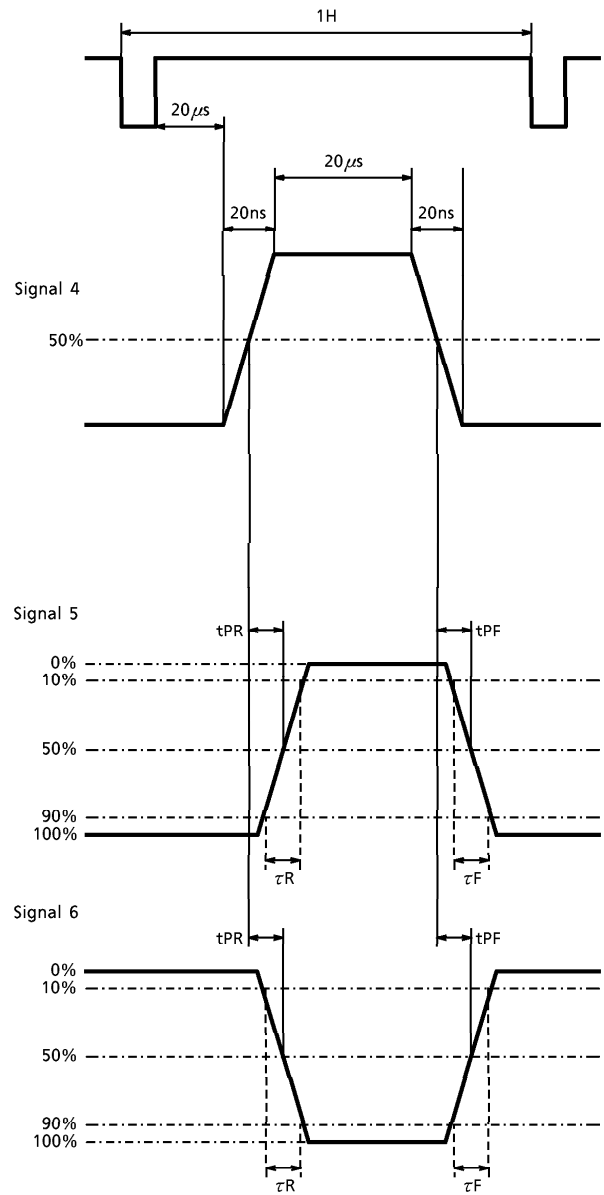
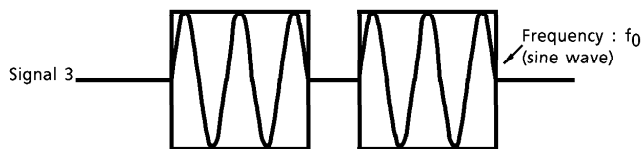
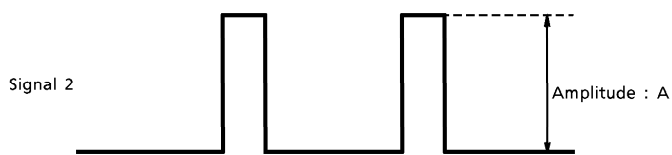
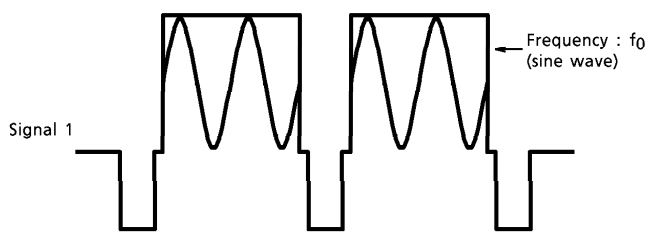
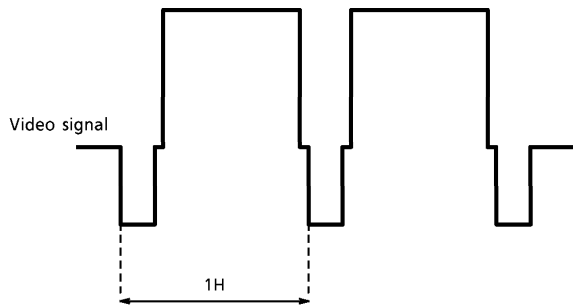

TEST CIRCUIT 1

For DC characteristics

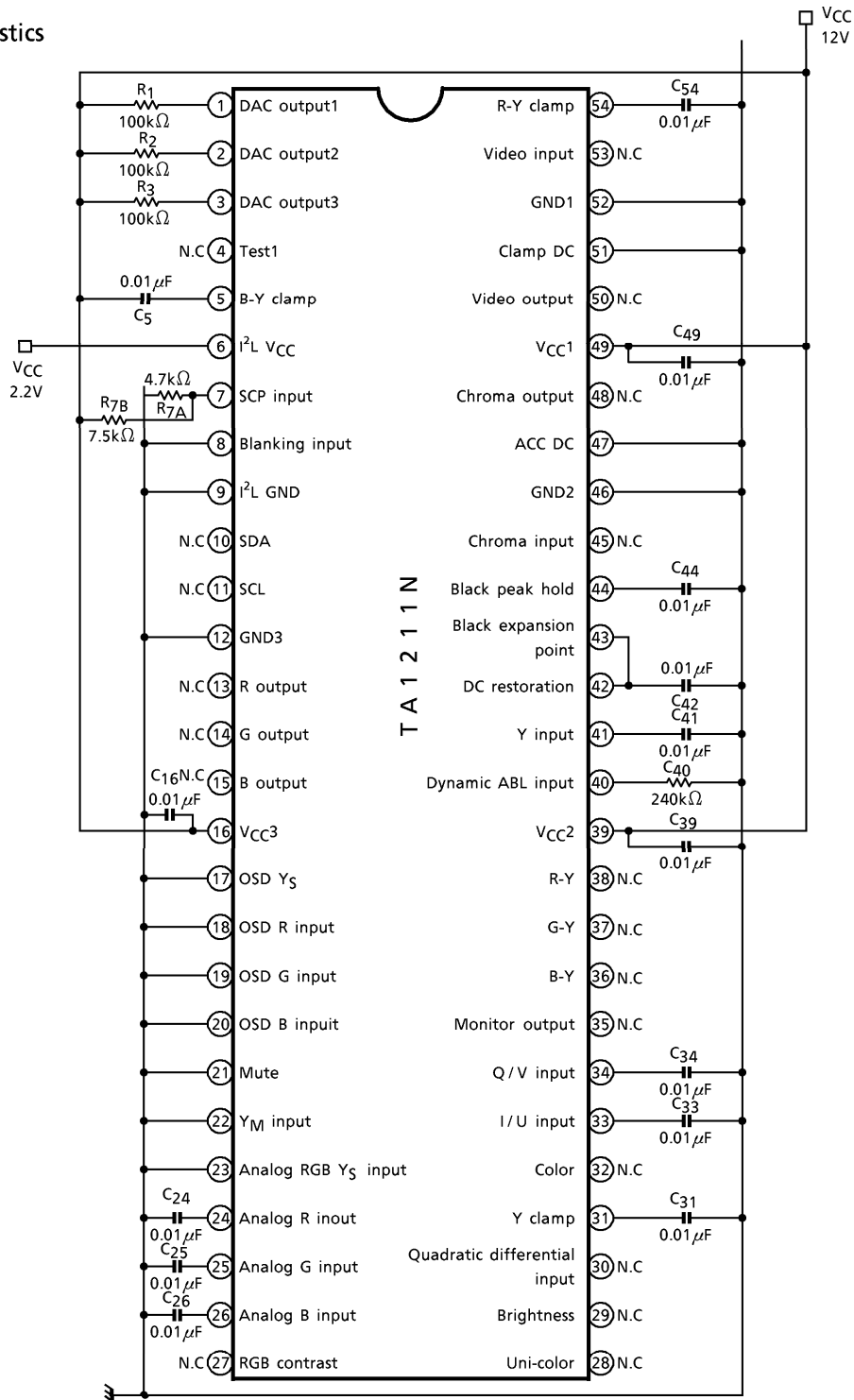

**TEST CIRCUIT 2**  
For clamp / ACC stage

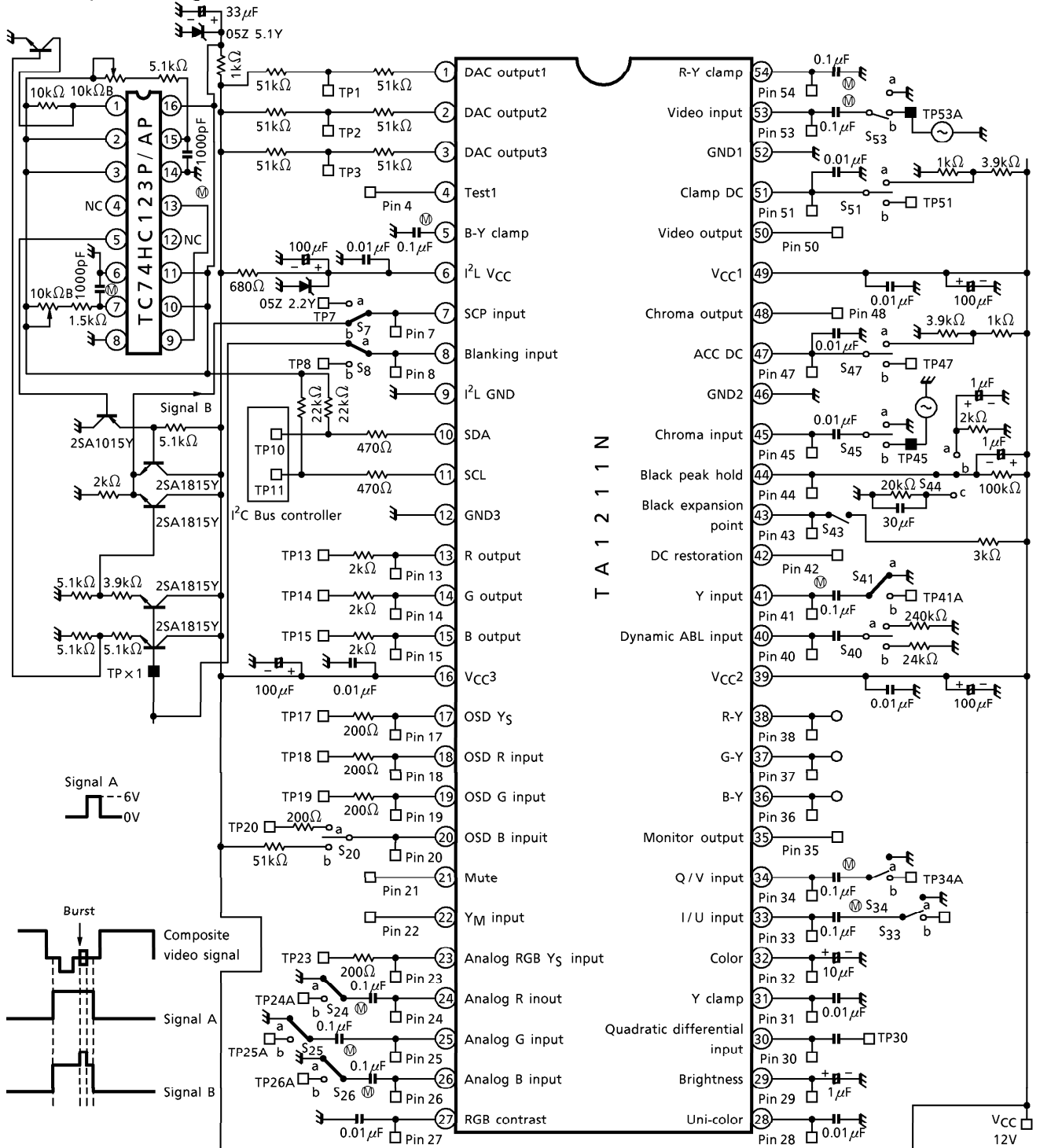

**TEST CIRCUIT 3**  
For video stage

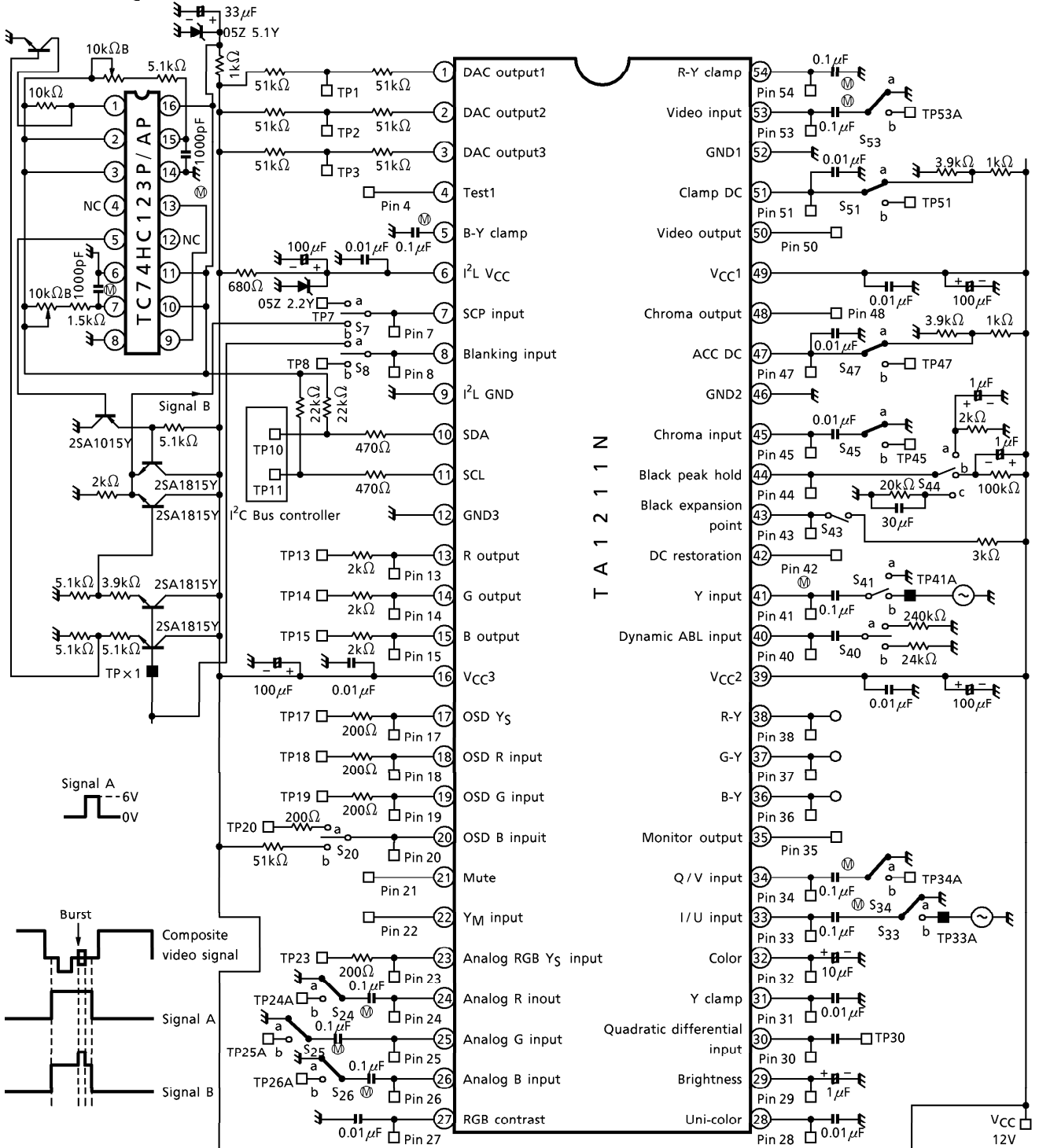

**TEST CIRCUIT 4**  
For chroma stage

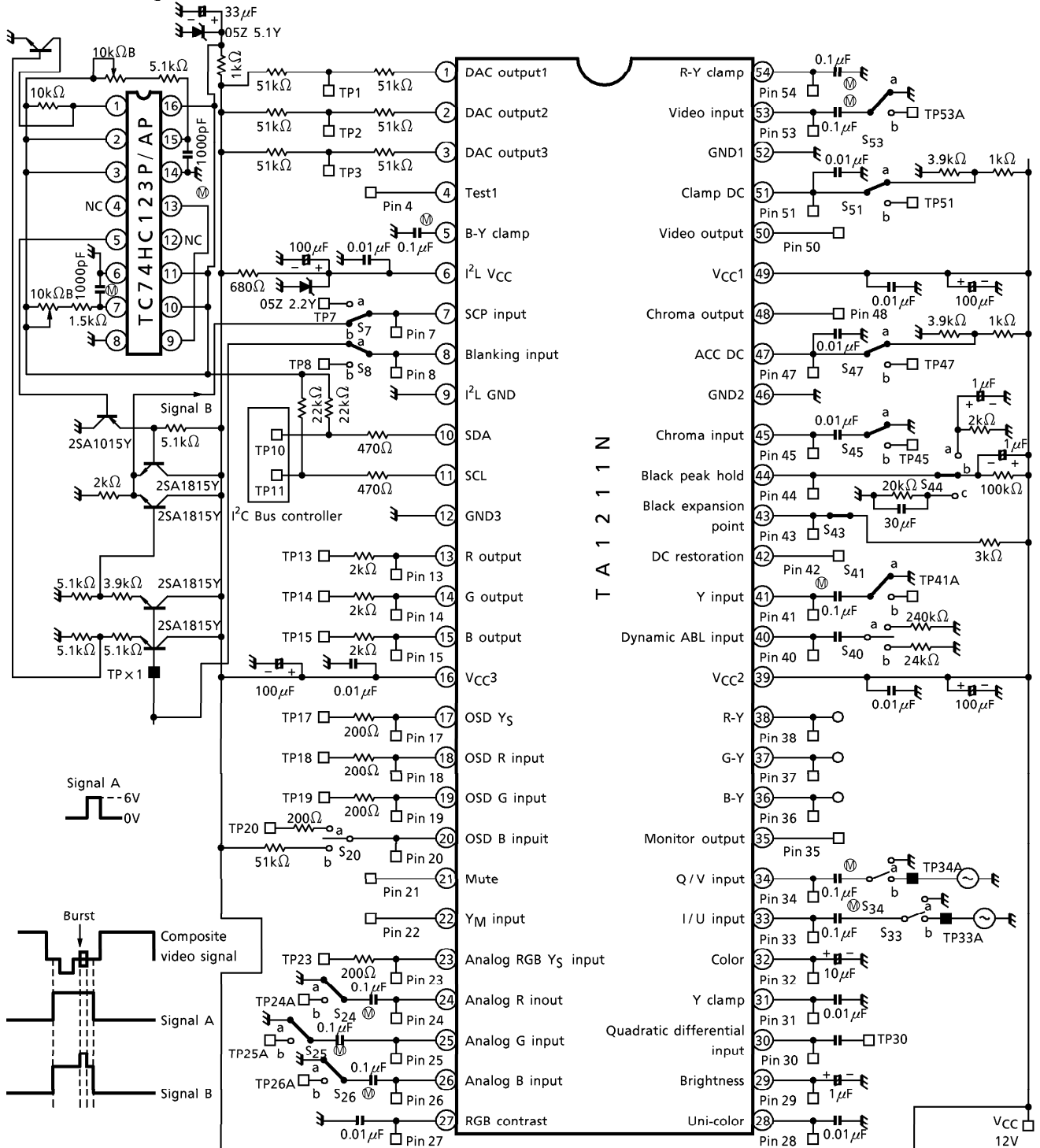

**TEST CIRCUIT 5**  
For text stage

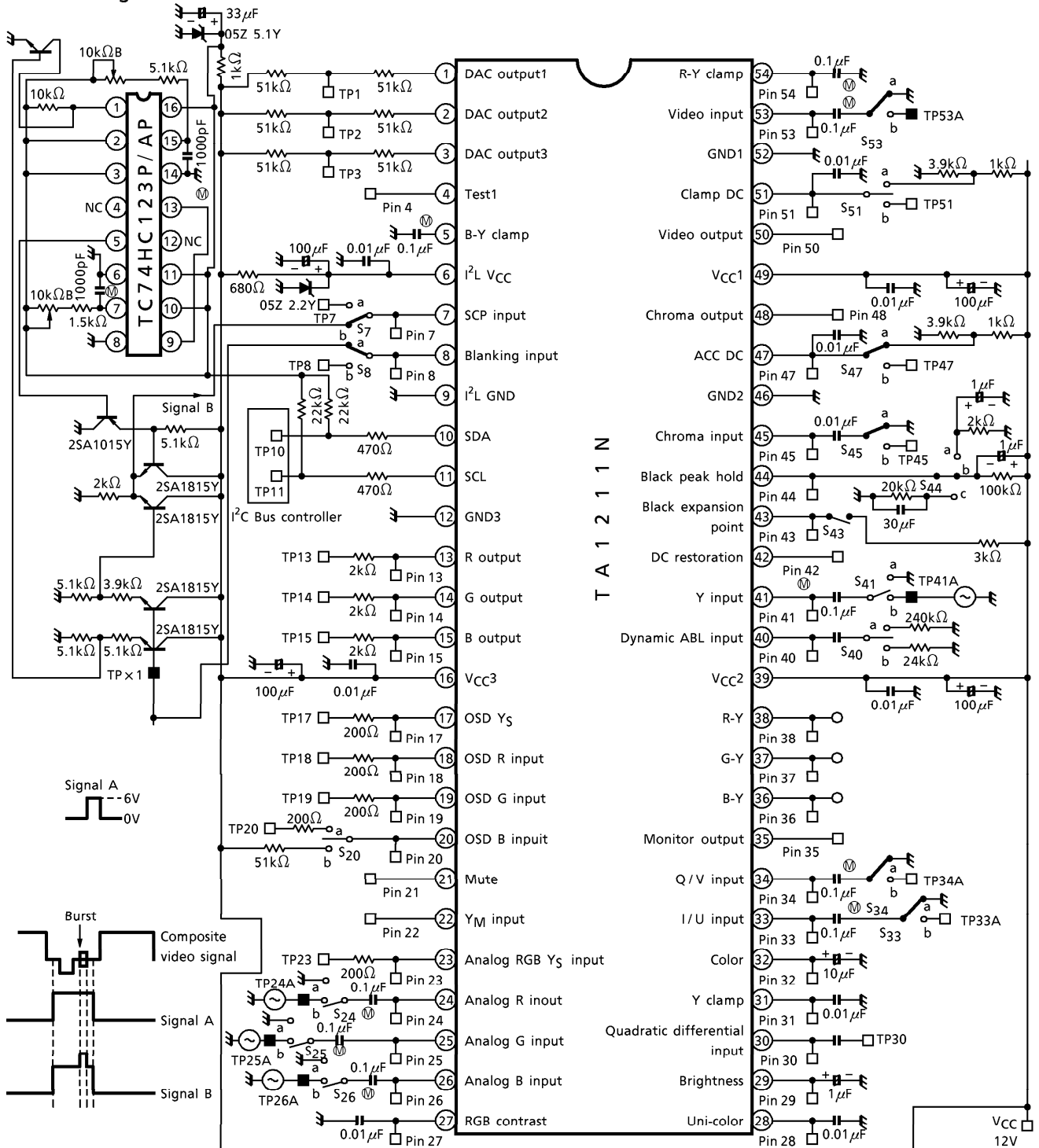





**OUTLINE DRAWING**  
SDIP54-P-600-1.78

Unit : mm

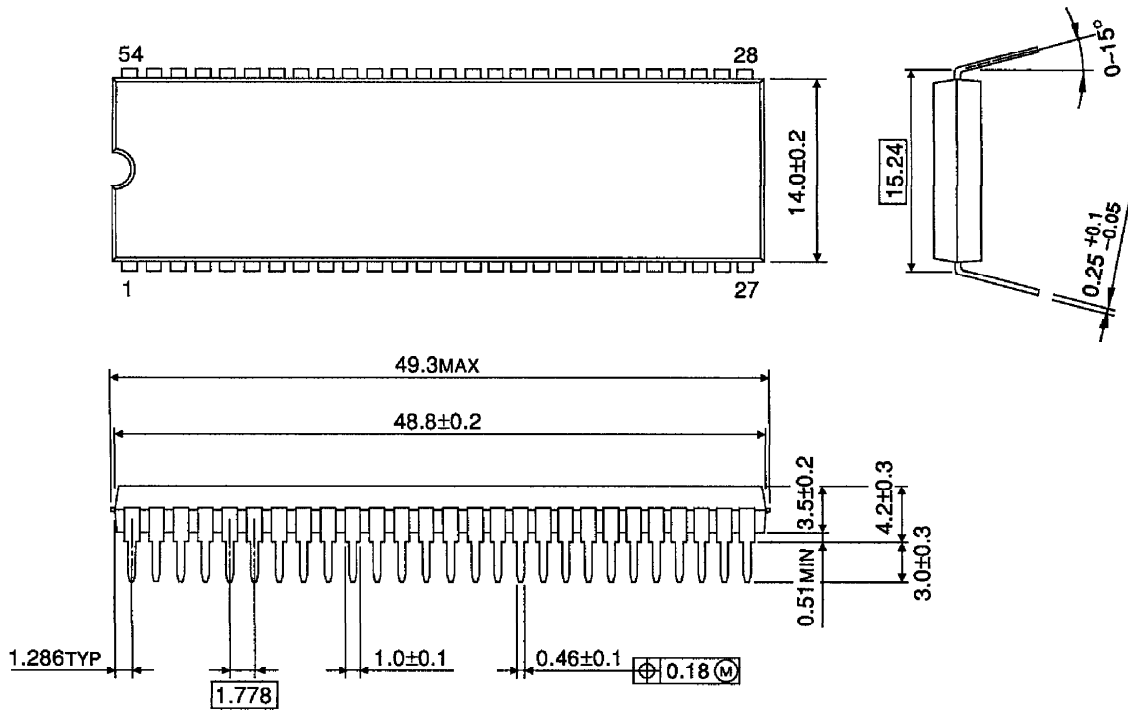

Weight : 5.44g (Typ.)