

Complementary Silicon Power Transistors

... specifically designed for general purpose amplifier and switching applications.

- Isolated Overmold Package (1500 Volts RMS Min)
- Electrically Similar to the Popular MJE3055T and MJE2955T
- Collector-Emitter Sustaining Voltage — $V_{CEO(sus)}$ 90 Volts
- 10 Amperes Rated Collector Current
- No Isolating Washers Required
- Reduced System Cost
- UL Recognized, File #E69369, to 3500 V_{RMS} Isolation

NPN
MJF3055
PNP
MJF2955

COMPLEMENTARY
SILICON
POWER TRANSISTORS
10 AMPERES
90 VOLTS
30 WATTS

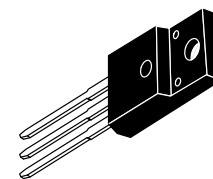

CASE 221D-02
TO-220 TYPE

MAXIMUM RATINGS

Rating	Symbol	Value	Unit
Collector-Emitter Sustaining Voltage	$V_{CEO(sus)}$	90	Vdc
Collector-Emitter Breakdown Voltage	V_{CES}	90	Vdc
Base-Emitter Voltage	V_{EBO}	5	Vdc
Collector Current — Continuous	I_C	10	Adc
Base Current — Continuous	I_B	6	Adc
RMS Isolation Voltage (3) (for 1 sec, R.H. < 30%, $T_A = 25^\circ\text{C}$)	V_{ISOL}	4500 3500 1500	V_{RMS}
Total Power Dissipation @ $T_C = 25^\circ\text{C}$ (2) Derate above 25°C	P_D	30 0.25	Watts W/ $^\circ\text{C}$
Total Power Dissipation @ $T_A = 25^\circ\text{C}$ Derate above 25°C	P_D	2 0.016	Watts W/ $^\circ\text{C}$
Operating and Storage Temperature Range	T_J, T_{stg}	-55 to +150	$^\circ\text{C}$

THERMAL CHARACTERISTICS

Characteristic	Symbol	Max	Unit
Thermal Resistance — Junction to Case (2)	$R_{\theta JC}$	4	$^\circ\text{C/W}$
Thermal Resistance — Junction to Ambient	$R_{\theta JA}$	62.5	$^\circ\text{C/W}$
Lead Temperature for Soldering Purposes	T_L	260	$^\circ\text{C}$

(1) Pulse Test: Pulse Width = 5 ms, Duty Cycle \leq 10%.

(2) Measurement made with thermocouple contacting the bottom insulated surface (in a location beneath the die), the devices mounted on a heatsink with thermal grease and a mounting torque of \geq 6 in. lbs.

(3) Proper strike and creepage distance must be provided.

MJF3055 MJF2955

ELECTRICAL CHARACTERISTICS ($T_C = 25^\circ\text{C}$ unless otherwise noted)

Characteristic	Symbol	Min	Max	Unit
OFF CHARACTERISTICS (1)				
Collector–Emitter Sustaining Voltage ($I_C = 200\text{ mAdc}$, $I_B = 0$)	$V_{CE(sus)}$	90	—	Vdc
Collector Cutoff Current ($V_{CE} = 90\text{ Vdc}$, $V_{BE} = 0$)	I_{CES}	—	1	μAdc
Collector Cutoff Current ($V_{CE} = 90\text{ Vdc}$, $I_E = 0$)	I_{CBO}	—	1	μAdc
Emitter–Base Leakage ($V_{EB} = 5\text{ Vdc}$, $I_C = 0$)	I_{EBO}	—	1	μAdc
ON CHARACTERISTICS (1)				
DC Current Gain ($I_{CE} = 4\text{ Adc}$, $V_{CE} = 4\text{ Vdc}$) ($I_{CE} = 10\text{ Adc}$, $V_{CE} = 4\text{ Vdc}$)	h_{FE}	20 5	100 —	—
Collector–Emitter Saturation Voltage ($I_C = 4\text{ Adc}$, $I_B = 0.4\text{ Adc}$) ($I_C = 10\text{ Adc}$, $I_B = 3.3\text{ Adc}$)	$V_{CE(sat)}$	— —	1 2.5	Vdc
Base–Emitter On Voltage ($I_C = 4\text{ Adc}$, $V_{BE} = 4\text{ Vdc}$)	$V_{BE(on)}$	—	1.5	Vdc
DYNAMIC CHARACTERISTICS				
Current–Gain–Bandwidth Product ($V_{CE} = 10\text{ Vdc}$, $I_C = 0.5\text{ Adc}$, $f_{test} = 500\text{ kHz}$)	f_T	2	—	MHz

(1) Pulse Test: Pulse Width = 5 ms, Duty Cycle $\leq 10\%$.

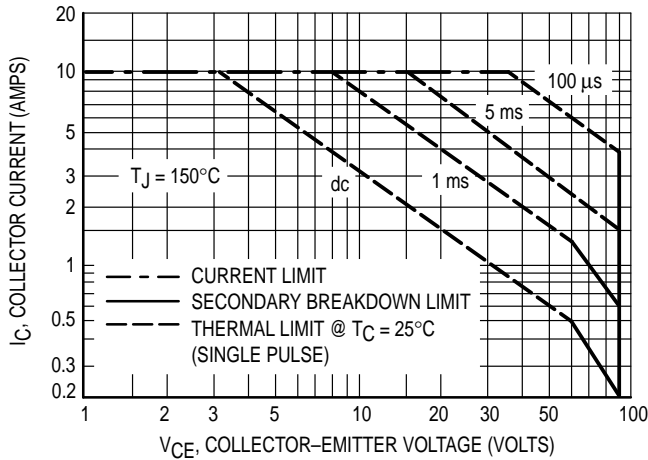

Figure 1. Maximum Forward Bias Safe Operating Area

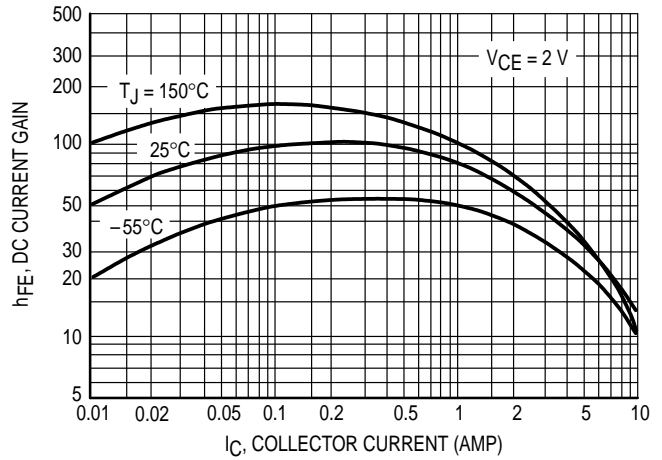

Figure 2. DC Current Gain

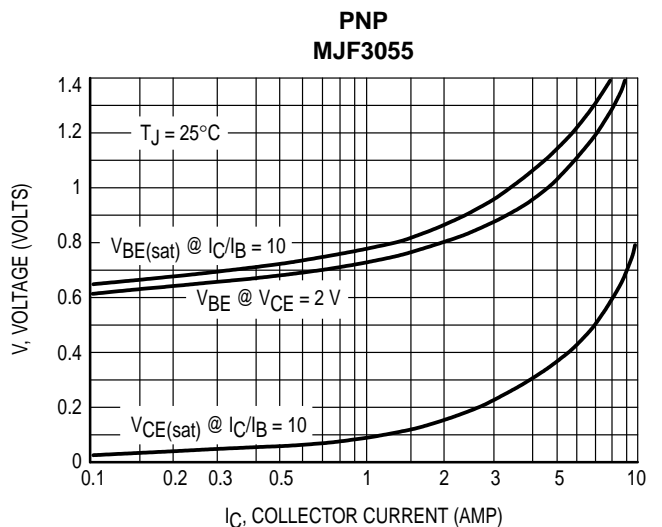
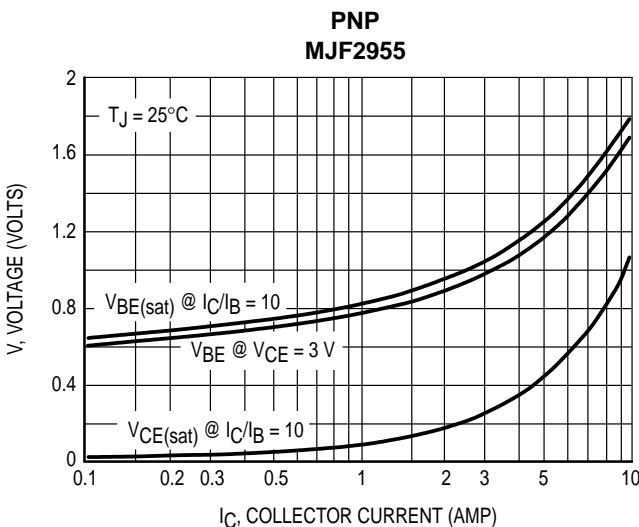
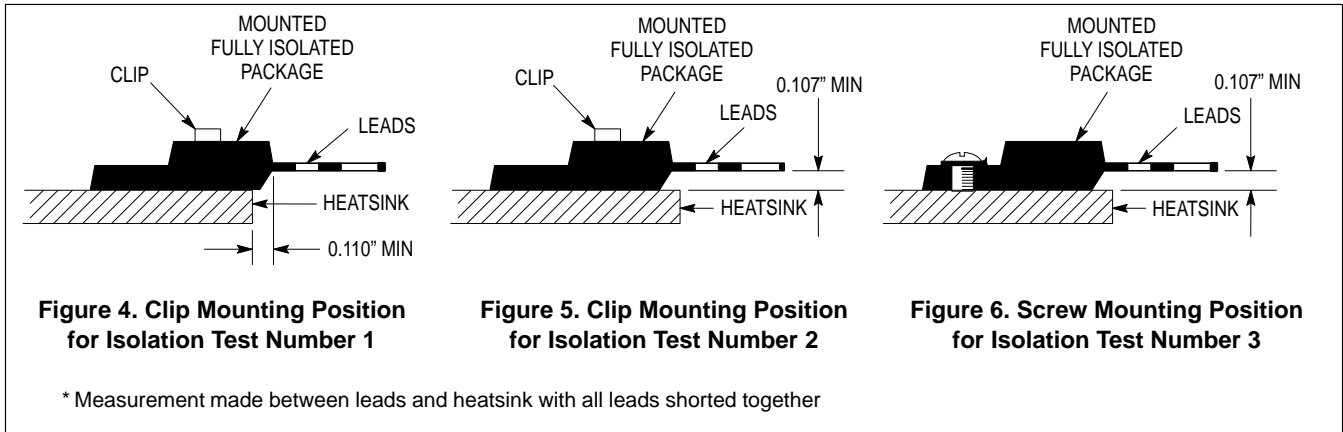
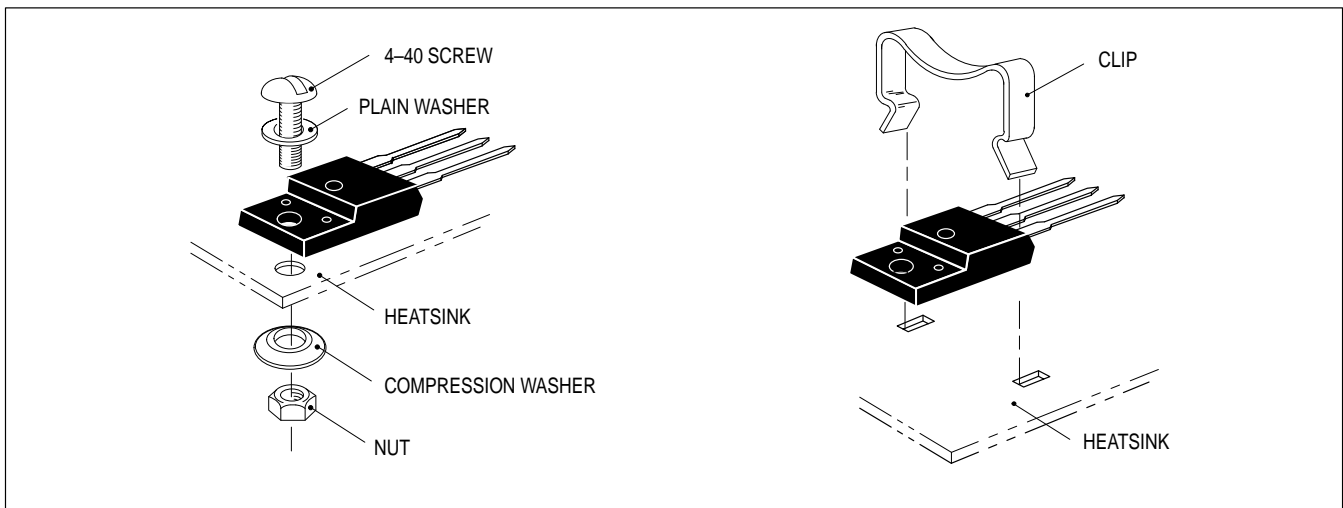

Figure 3. "On" Voltages

TEST CONDITIONS FOR ISOLATION TESTS*



MOUNTING INFORMATION



Laboratory tests on a limited number of samples indicate, when using the screw and compression washer mounting technique, a screw torque of 6 to 8 in · lbs is sufficient to provide maximum power dissipation capability. The compression washer helps to maintain a constant pressure on the package over time and during large temperature excursions.

Destructive laboratory tests show that using a hex head 4-40 screw, without washers, and applying a torque in excess of 20 in · lbs will cause the plastic to crack around the mounting hole, resulting in a loss of isolation capability.

Additional tests on slotted 4-40 screws indicate that the screw slot fails between 15 to 20 in · lbs without adversely affecting the package. However, in order to positively ensure the package integrity of the fully isolated device, Motorola does not recommend exceeding 10 in · lbs of mounting torque under any mounting conditions.

** For more information about mounting power semiconductors see Application Note AN1040.

PACKAGE DIMENSIONS

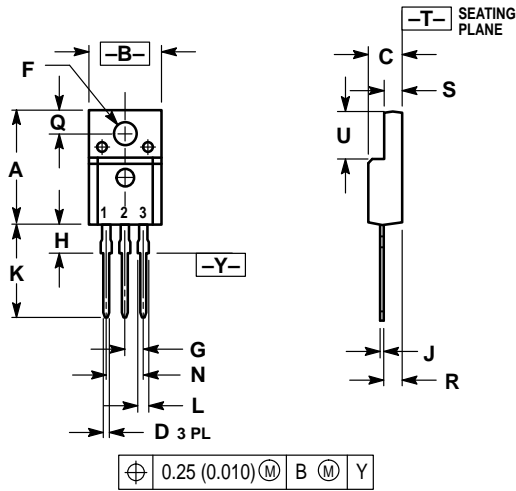

- NOTES:
 1. DIMENSIONING AND TOLERANCING PER ANSI Y14.5M, 1982.
 2. CONTROLLING DIMENSION: INCH.

DIM	INCHES		MILLIMETERS	
	MIN	MAX	MIN	MAX
A	0.621	0.629	15.78	15.97
B	0.394	0.402	10.01	10.21
C	0.181	0.189	4.60	4.80
D	0.026	0.034	0.67	0.86
F	0.121	0.129	3.08	3.27
G	0.100 BSC		2.54 BSC	
H	0.123	0.129	3.13	3.27
J	0.018	0.025	0.46	0.64
K	0.500	0.562	12.70	14.27
L	0.045	0.060	1.14	1.52
N	0.200 BSC		5.08 BSC	
Q	0.126	0.134	3.21	3.40
R	0.107	0.111	2.72	2.81
S	0.096	0.104	2.44	2.64
U	0.259	0.267	6.58	6.78

- STYLE 2:
 PIN 1. BASE
 2. COLLECTOR
 3. EMITTER

CASE 221D-02
 TO-220 TYPE
 ISSUE D

Motorola reserves the right to make changes without further notice to any products herein. Motorola makes no warranty, representation or guarantee regarding the suitability of its products for any particular purpose, nor does Motorola assume any liability arising out of the application or use of any product or circuit, and specifically disclaims any and all liability, including without limitation consequential or incidental damages. "Typical" parameters can and do vary in different applications. All operating parameters, including "Typicals" must be validated for each customer application by customer's technical experts. Motorola does not convey any license under its patent rights nor the rights of others. Motorola products are not designed, intended, or authorized for use as components in systems intended for surgical implant into the body, or other applications intended to support or sustain life, or for any other application in which the failure of the Motorola product could create a situation where personal injury or death may occur. Should Buyer purchase or use Motorola products for any such unintended or unauthorized application, Buyer shall indemnify and hold Motorola and its officers, employees, subsidiaries, affiliates, and distributors harmless against all claims, costs, damages, and expenses, and reasonable attorney fees arising out of, directly or indirectly, any claim of personal injury or death associated with such unintended or unauthorized use, even if such claim alleges that Motorola was negligent regarding the design or manufacture of the part. Motorola and are registered trademarks of Motorola, Inc. Motorola, Inc. is an Equal Opportunity/Affirmative Action Employer.

How to reach us:
 USA / EUROPE: Motorola Literature Distribution;
 P.O. Box 20912; Phoenix, Arizona 85036. 1-800-441-2447

JAPAN: Nippon Motorola Ltd.; Tatsumi-SPD-JLDC, Toshikatsu Otsuki,
 6F Seibu-Butsuryu-Center, 3-14-2 Tatsumi Koto-Ku, Tokyo 135, Japan. 03-3521-8315

MFAX: RMFAX0@email.sps.mot.com - TOUCHTONE (602) 244-6609
 INTERNET: http://Design-NET.com

HONG KONG: Motorola Semiconductors H.K. Ltd.; 8B Tai Ping Industrial Park,
 51 Ting Kok Road, Tai Po, N.T., Hong Kong. 852-26629298

