

Advance Information

Power Manager™

Gallium Arsenide Power Rectifier

MGR2025CT

**GALLIUM ARSENIDE
RECTIFIER
20 AMPERES
250 VOLTS**

... ideally suited for high frequency power supplies, free wheeling diodes, and as polarity protection diodes, these state-of-the-art devices have the following features:

- Planar Epitaxial Construction
- Nitride Passivation for Stable Blocking Characteristics
- Monolithic Dual Die Construction – May be Paralleled for High Current Output (10A per leg or 20A per package)
- Epoxy Meets UL94, V_O @ 1/8"
- Hyperfast and Soft Reverse Recovery Over Specified Temperature Range (15 ns)

Mechanical Characteristics

- Case: Epoxy, Molded
- Weight: 1.9 grams (approximately)
- Finish: All External Surfaces Corrosion Resistant and Terminal Leads are Readily Solderable
- Lead Temperature for Soldering Purposes: 260°C Max. for 10 Seconds
- Shipped 50 units per plastic tube
- Marking: MGR2025CT

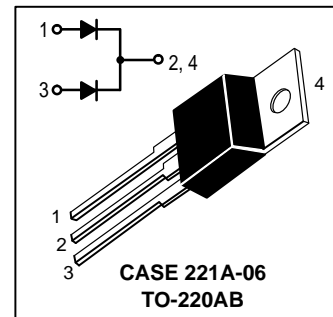

MAXIMUM RATINGS

Rating	Symbol	Value	Unit
Peak Repetitive Reverse Voltage Working Peak Reverse Voltage DC Blocking Voltage	V _{RRM} V _{RWM} V _R	250	V
DC Forward Current (T _C = 95°C) Per Leg	I _{DC}	10	A
Peak Repetitive Forward Current (At Rated V _R , Square Wave, 20 kHz, T _C = 25°C) Per Leg	I _{FRM}	20	A
Non-Repetitive Peak Surge Current (Surge applied at rated load conditions, halfwave, single phase, 60 Hz) Per Package	I _{FSM}	40	A
Operating Junction Temperature and Storage Temperature	T _J , T _{stg}	-55 to 175	°C

THERMAL CHARACTERISTICS

Thermal Resistance – Junction to Case	Per Leg	R _{θJC}	3.1	°C/W
Thermal Resistance – Junction to Ambient	Per Leg	R _{θJA}	64	

ELECTRICAL CHARACTERISTICS

Maximum Instantaneous Forward Voltage (1), see Figure 2 (I _F = 10 A) (I _F = 5 A)	Per Leg	V _F	T _J =25°C	T _J =125°C	V
			2.2 1.5	2.5 1.6	
Maximum Instantaneous Reverse Current, see Figure 4 (V _R = 250 V) (V _R = 125 V)	Per Leg	I _R	T _J =25°C	T _J =125°C	μA
			25 2	440 125	
Typical Reverse Recovery Time (2) (V _R = 200 V, I _F = 5 A, di/dt = 200 A/μs) (V _R = 200 V, I _F = 10 A, di/dt = 200 A/μs)	Per Leg	t _{rr}	T _J =25°C	T _J =125°C	ns
			11.8 12.2	12.0 12.2	
Typical Peak Reverse Recovery Current (V _R = 200 V, I _F = 5 A, di/dt = 200 A/μs) (V _R = 200 V, I _F = 10 A, di/dt = 200 A/μs)	Per Leg	I _{RM}	T _J =25°C	T _J =125°C	A
			1.4 1.5	1.4 1.5	

Note: This data sheet contains advance information only and is subject to change without notice.

(1) Pulse Test: Pulse Width = 300 μs, Duty Cycle ≤ 2.0%.

(2) t_{rr} measured projecting from 25% of I_{RM} to ground.

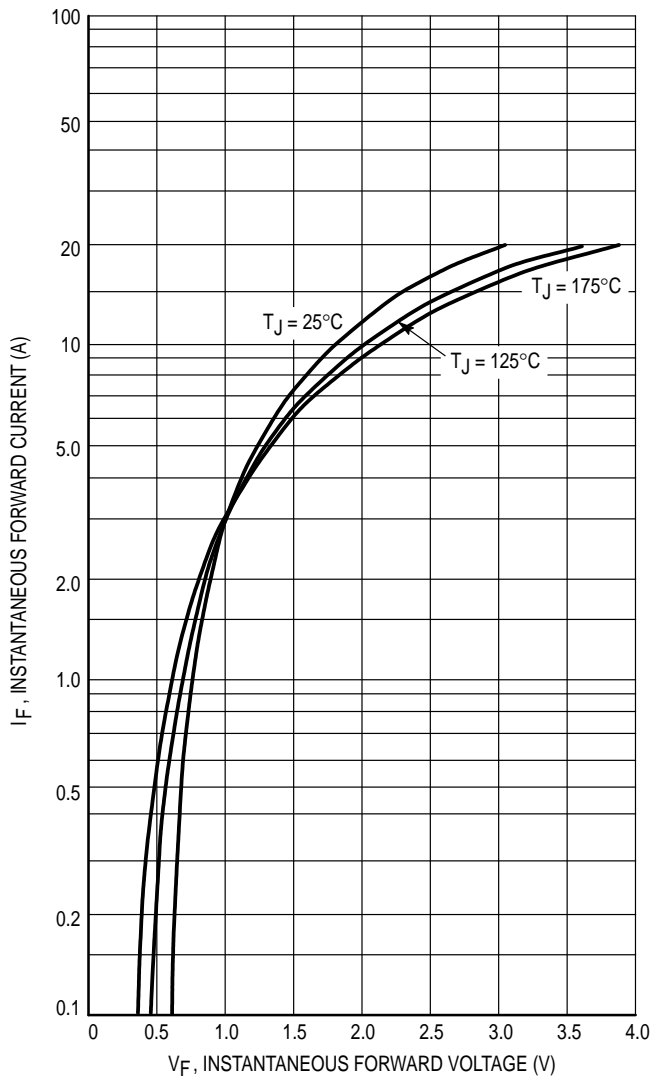

Figure 1. Typical Forward Voltage

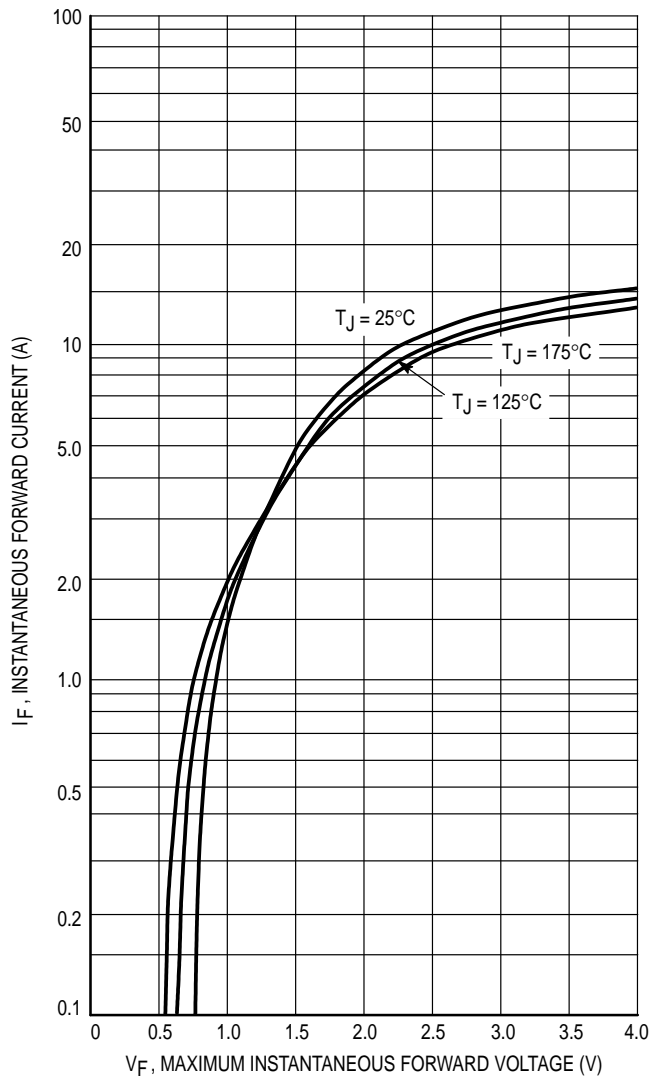

Figure 2. Maximum Forward Voltage

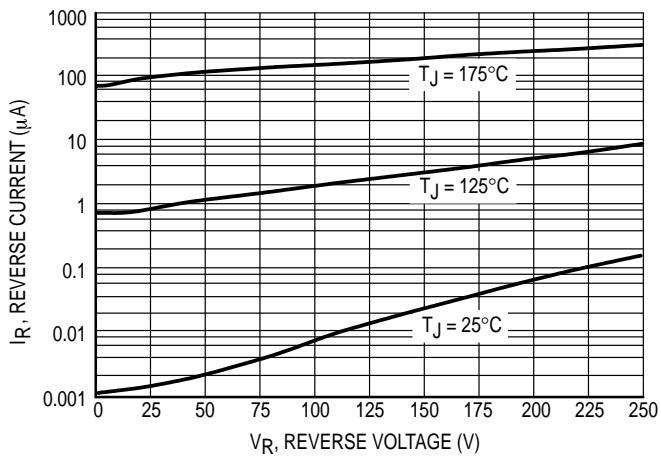

Figure 3. Typical Reverse Current

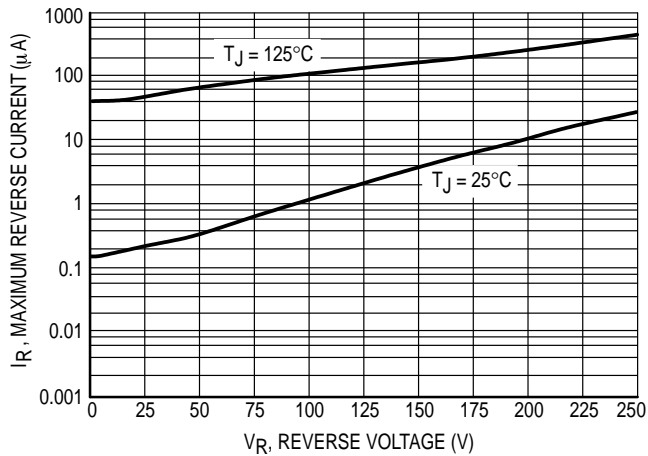

Figure 4. Maximum Reverse Current

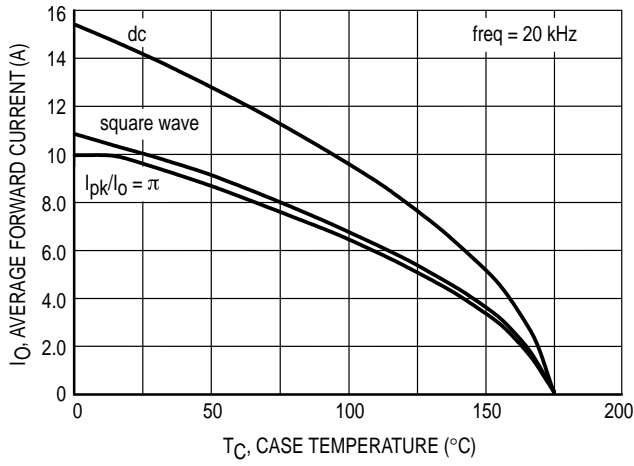

Figure 5. Current Derating Per Leg

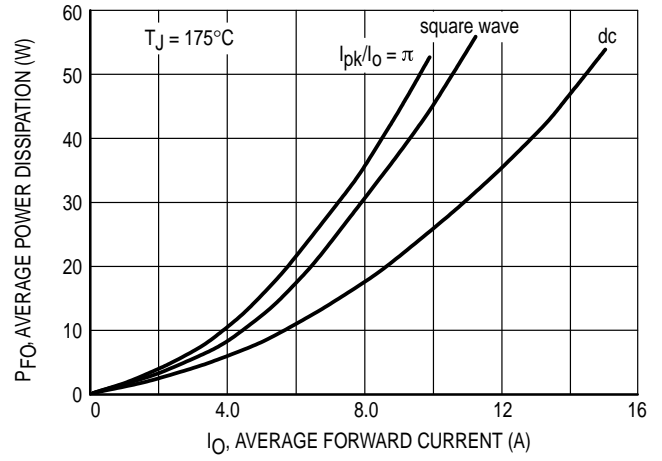

Figure 6. Forward Power Dissipation Per Leg

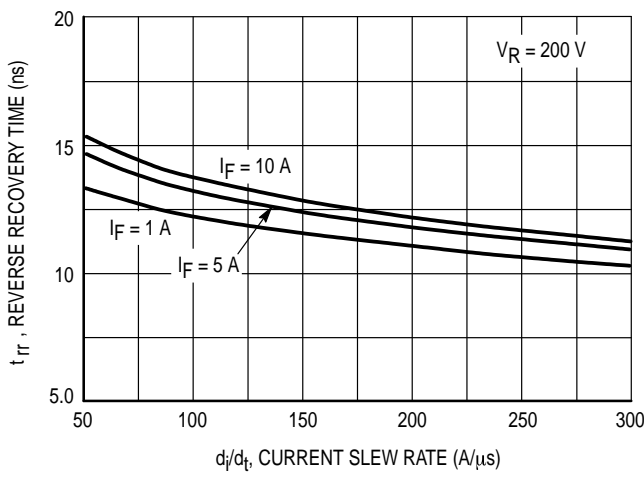

Figure 7. Typical t_{rr} Characteristics, $T_J = 25^\circ\text{C}$

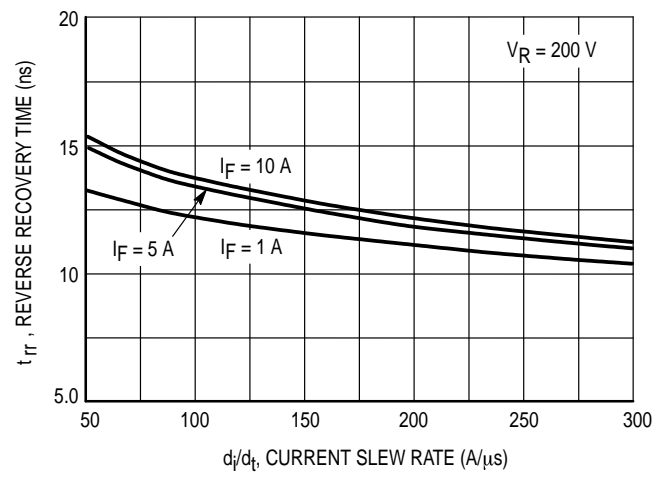

Figure 8. Typical t_{rr} Characteristics, $T_J = 125^\circ\text{C}$

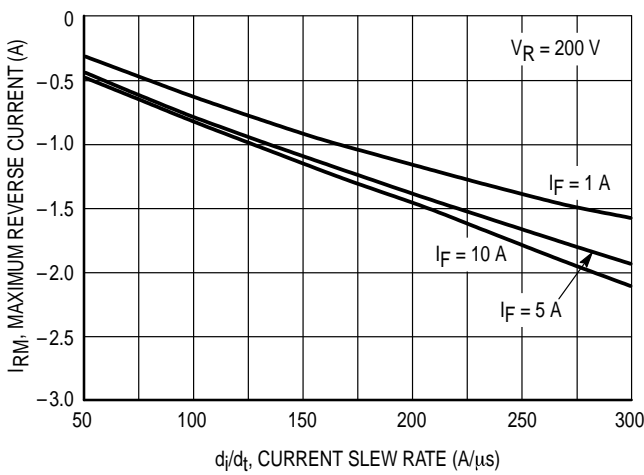

Figure 9. Typical I_{RM} Characteristics, $T_J = 25^\circ\text{C}$

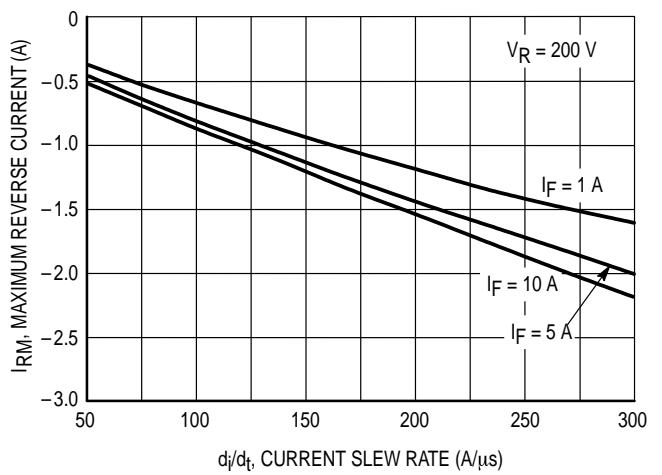

Figure 10. Typical I_{RM} Characteristics, $T_J = 125^\circ\text{C}$

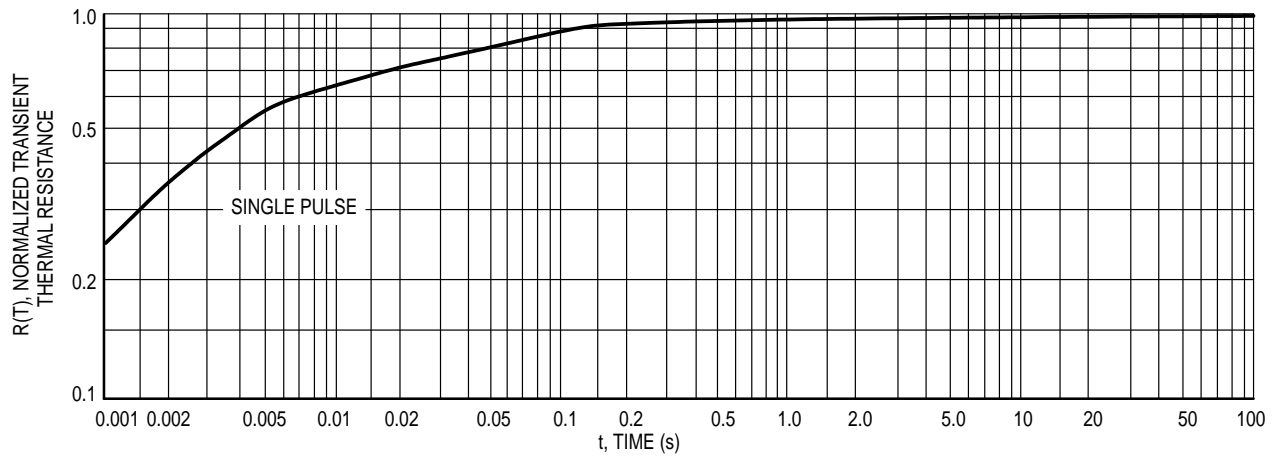

Figure 11. Typical Thermal Response

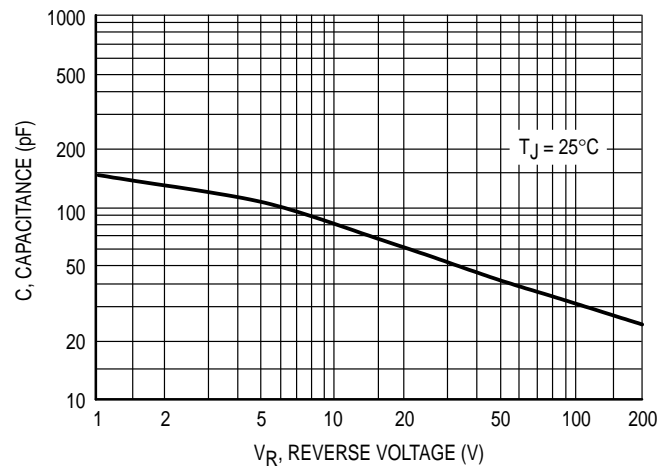
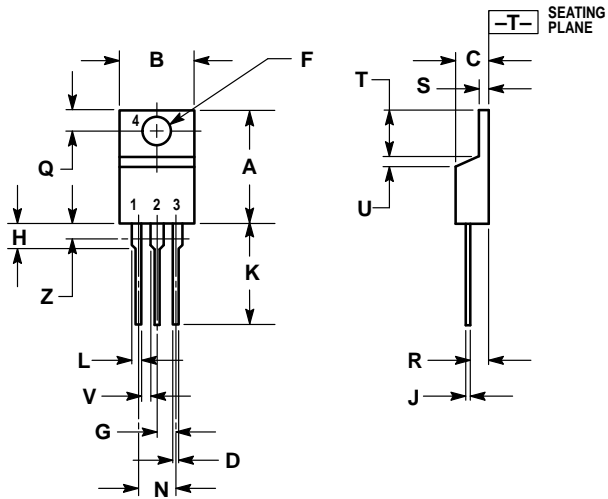

Figure 12. Typical Capacitance

PACKAGE DIMENSIONS



STYLE 6:
 PIN 1. ANODE
 2. CATHODE
 3. ANODE
 4. CATHODE

- NOTES:
 1. DIMENSIONING AND TOLERANCING PER ANSI Y14.5M, 1982.
 2. CONTROLLING DIMENSION: INCH.
 3. DIMENSION Z DEFINES A ZONE WHERE ALL BODY AND LEAD IRREGULARITIES ARE ALLOWED.

DIM	INCHES		MILLIMETERS	
	MIN	MAX	MIN	MAX
A	0.570	0.620	14.48	15.75
B	0.380	0.405	9.66	10.28
C	0.160	0.190	4.07	4.82
D	0.025	0.035	0.64	0.88
F	0.142	0.147	3.61	3.73
G	0.095	0.105	2.42	2.66
H	0.110	0.155	2.80	3.93
J	0.018	0.025	0.46	0.64
K	0.500	0.562	12.70	14.27
L	0.045	0.060	1.15	1.52
N	0.190	0.210	4.83	5.33
Q	0.100	0.120	2.54	3.04
R	0.080	0.110	2.04	2.79
S	0.045	0.055	1.15	1.39
T	0.235	0.255	5.97	6.47
U	0.000	0.050	0.00	1.27
V	0.045	—	1.15	—
Z	—	0.080	—	2.04

CASE 221A-06
 ISSUE Y

Motorola reserves the right to make changes without further notice to any products herein. Motorola makes no warranty, representation or guarantee regarding the suitability of its products for any particular purpose, nor does Motorola assume any liability arising out of the application or use of any product or circuit, and specifically disclaims any and all liability, including without limitation consequential or incidental damages. "Typical" parameters can and do vary in different applications. All operating parameters, including "Typicals" must be validated for each customer application by customer's technical experts. Motorola does not convey any license under its patent rights nor the rights of others. Motorola products are not designed, intended, or authorized for use as components in systems intended for surgical implant into the body, or other applications intended to support or sustain life, or for any other application in which the failure of the Motorola product could create a situation where personal injury or death may occur. Should Buyer purchase or use Motorola products for any such unintended or unauthorized application, Buyer shall indemnify and hold Motorola and its officers, employees, subsidiaries, affiliates, and distributors harmless against all claims, costs, damages, and expenses, and reasonable attorney fees arising out of, directly or indirectly, any claim of personal injury or death associated with such unintended or unauthorized use, even if such claim alleges that Motorola was negligent regarding the design or manufacture of the part. Motorola and  are registered trademarks of Motorola, Inc. Motorola, Inc. is an Equal Opportunity/Affirmative Action Employer.

How to reach us:

USA / EUROPE: Motorola Literature Distribution;
P.O. Box 20912; Phoenix, Arizona 85036. 1-800-441-2447

JAPAN: Nippon Motorola Ltd.; Tatsumi-SPD-JLDC, Toshikatsu Otsuki,
6F Seibu-Butsuryu-Center, 3-14-2 Tatsumi Koto-Ku, Tokyo 135, Japan. 03-3521-8315

MFAX: RMFAX0@email.sps.mot.com - TOUCHTONE (602) 244-6609
INTERNET: <http://Design-NET.com>

HONG KONG: Motorola Semiconductors H.K. Ltd.; 8B Tai Ping Industrial Park,
51 Ting Kok Road, Tai Po, N.T., Hong Kong. 852-26629298



MGR2025CT/D

