

PNP Silicon AF Transistors

BCW 67
BCW 68

- For general AF applications
- High current gain
- Low collector-emitter saturation voltage
- Complementary types: BCW 65, BCW 66 (NPN)

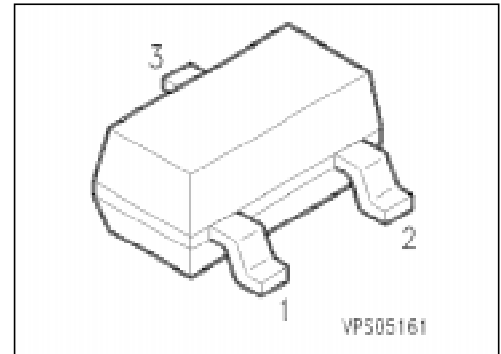

Type	Marking	Ordering Code (tape and reel)	Pin Configuration			Package ¹⁾
			1	2	3	
BCW 67 A	DAs	Q62702-C1560	B	E	C	SOT-23
BCW 67 B	DBs	Q62702-C1480				
BCW 67 C	DCs	Q62702-C1681				
BCW 68 F	DFs	Q62702-C1893				
BCW 68 G	DGs	Q62702-C1322				
BCW 68 H	DHs	Q62702-C1555				

¹⁾ For detailed information see chapter Package Outlines.

Maximum Ratings

Parameter	Symbol	Values		Unit
		BCW 67	BCW 68	
Collector-emitter voltage	V_{CE0}	32	45	V
Collector-base voltage	V_{CB0}	45	60	
Emitter-base voltage	V_{EB0}	5	5	
Collector current	I_C	800		mA
Peak collector current	I_{CM}	1		A
Base current	I_B	100		mA
Peak base current	I_{BM}	200		
Total power dissipation, $T_s = 79\text{ °C}$	P_{tot}	330		mW
Junction temperature	T_j	150		°C
Storage temperature range	T_{stg}	- 65 ... + 150		

Thermal Resistance

Junction - ambient ¹⁾	$R_{th JA}$	≤ 285	K/W
Junction - soldering point	$R_{th JS}$	≤ 215	

¹⁾ Package mounted on epoxy pcb 40 mm × 40 mm × 1.5 mm/6 cm² Cu.

Electrical Characteristics

at $T_A = 25\text{ °C}$, unless otherwise specified.

Parameter	Symbol	Values			Unit
		min.	typ.	max.	

DC characteristics

Collector-emitter breakdown voltage $I_C = 10\text{ mA}$	$V_{(BR)CE0}$				V
BCW 67		32	—	—	
BCW 68		45	—	—	
Collector-base breakdown voltage $I_C = 10\text{ }\mu\text{A}$	$V_{(BR)CB0}$				
BCW 67		45	—	—	
BCW 68		60	—	—	
Emitter-base breakdown voltage, $I_E = 10\text{ }\mu\text{A}$	$V_{(BR)EB0}$	5	—	—	
Collector cutoff current $V_{CB} = 32\text{ V}$	I_{CB0}				nA
BCW 67		—	—	20	
$V_{CB} = 45\text{ V}$					nA
BCW 68		—	—	20	
$V_{CB} = 32\text{ V}, T_A = 150\text{ °C}$					μA
BCW 67		—	—	20	
$V_{CB} = 45\text{ V}, T_A = 150\text{ °C}$					μA
BCW 68		—	—	20	
Emitter-base cutoff current, $V_{EB} = 4\text{ V}$	I_{EB0}	—	—	20	nA
DC current gain ¹⁾ $I_C = 100\text{ }\mu\text{A}, V_{CE} = 10\text{ V}$	h_{FE}				—
BCW 67 A, BCW 68 F		35	—	—	
BCW 67 B, BCW 68 G		50	—	—	
BCW 67 C, BCW 68 H		80	—	—	
$I_C = 10\text{ mA}, V_{CE} = 1\text{ V}$					
BCW 67 A, BCW 68 F		75	—	—	
BCW 67 B, BCW 68 G		120	—	—	
BCW 67 C, BCW 68 H		180	—	—	
$I_C = 100\text{ mA}, V_{CE} = 1\text{ V}$					
BCW 67 A, BCW 68 F		100	160	250	
BCW 67 B, BCW 68 G		160	250	400	
BCW 67 C, BCW 68 H		250	350	630	
$I_C = 500\text{ mA}, V_{CE} = 2\text{ V}$					
BCW 67 A, BCW 68 F		35	—	—	
BCW 67 B, BCW 68 G		60	—	—	
BCW 67 C, BCW 68 H		100	—	—	

¹⁾ Pulse test: $t \leq 300\text{ }\mu\text{s}, D = 2\%$.

Electrical Characteristics

at $T_A = 25\text{ °C}$, unless otherwise specified.

Parameter	Symbol	Values			Unit
		min.	typ.	max.	

DC characteristics

Collector-emitter saturation voltage ¹⁾ $I_C = 100\text{ mA}$, $I_B = 10\text{ mA}$ $I_C = 500\text{ mA}$, $I_B = 50\text{ mA}$	V_{CEsat}	–	–	0.3 0.7	V
Base-emitter saturation voltage ¹⁾ $I_C = 100\text{ mA}$, $I_B = 10\text{ mA}$ $I_C = 500\text{ mA}$, $I_B = 50\text{ mA}$	V_{BEsat}	–	–	1.25 2	

AC characteristics

Transition frequency $I_C = 50\text{ mA}$, $V_{CE} = 5\text{ V}$, $f = 20\text{ MHz}$	f_T	–	200	–	MHz
Output capacitance $V_{CB} = 10\text{ V}$, $f = 1\text{ MHz}$	C_{obo}	–	6	–	pF
Input capacitance $V_{EB} = 0.5\text{ V}$, $f = 1\text{ MHz}$	C_{ibo}	–	60	–	

¹⁾ Pulse test: $t \leq 300\text{ }\mu\text{s}$, $D = 2\text{ %}$.

Total power dissipation $P_{tot} = f(T_A^*; T_S)$

* Package mounted on epoxy

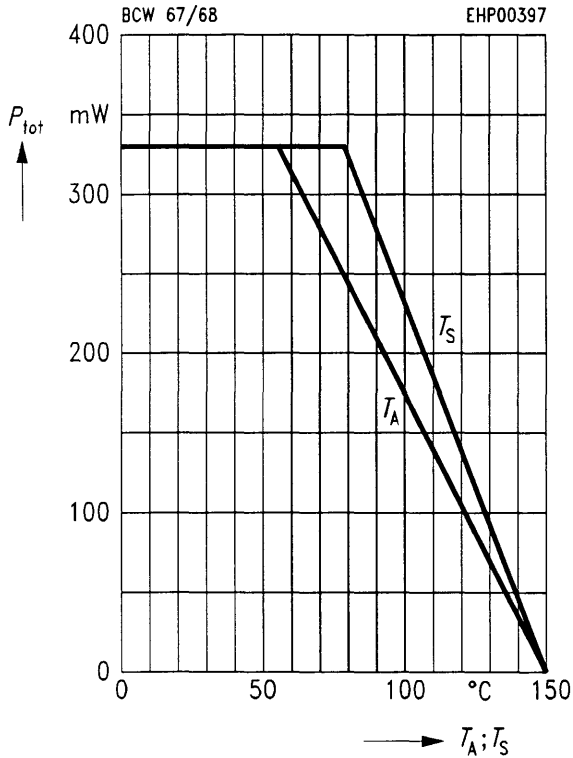

Transition frequency $f_T = f(I_C)$

$V_{CE} = 5 V$

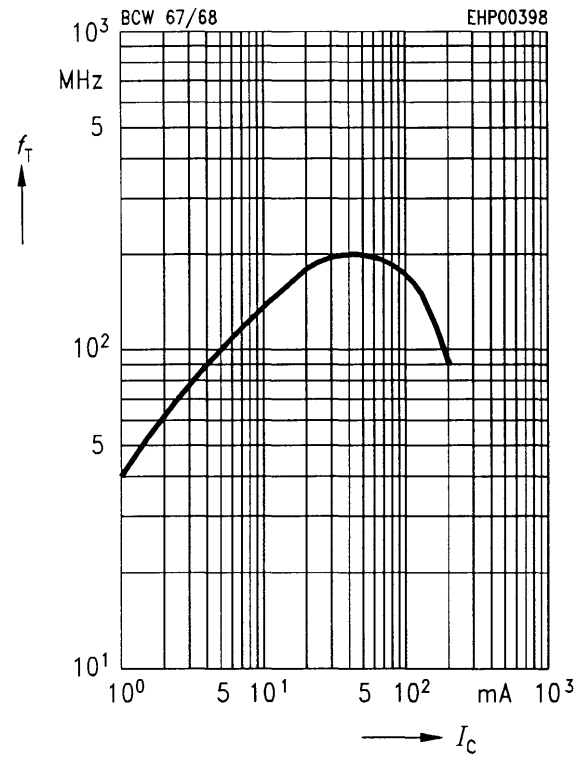

Permissible pulse load $P_{tot max}/P_{tot DC} = f(t_p)$

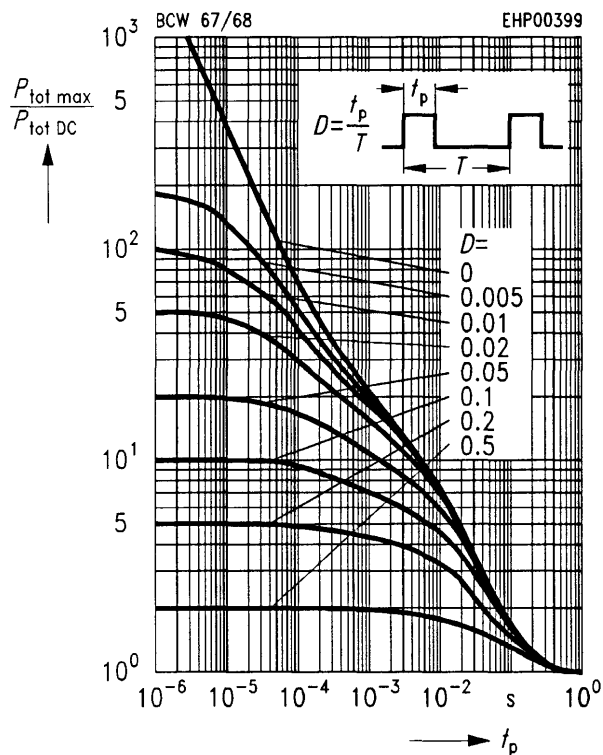

Collector cutoff current $I_{CB0} = f(T_A)$

$V_{CB} = V_{CEmax}$

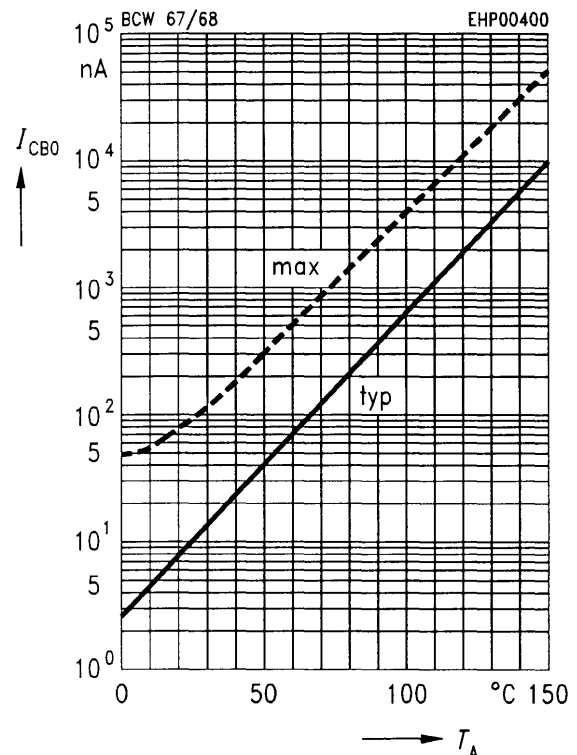

Base-emitter saturation voltage

$I_C = f(V_{BEsat})$

$h_{FE} = 10$

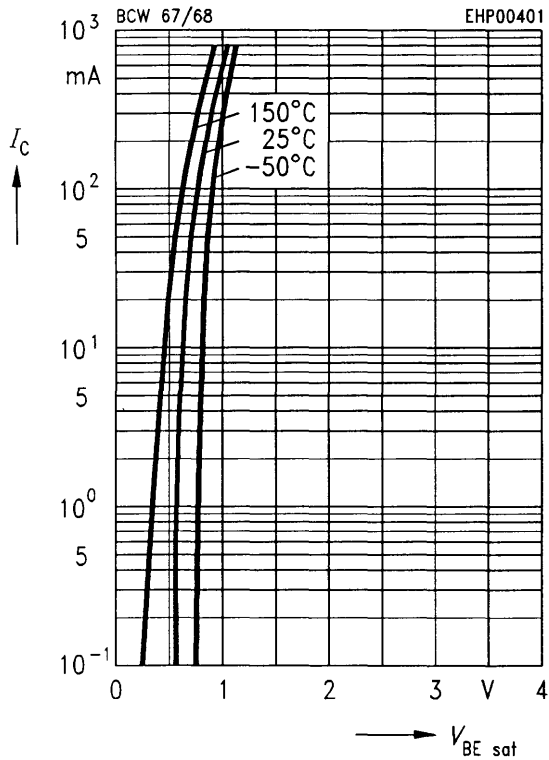

Collector-emitter saturation voltage

$I_C = f(V_{CEsat})$

$h_{FE} = 10$

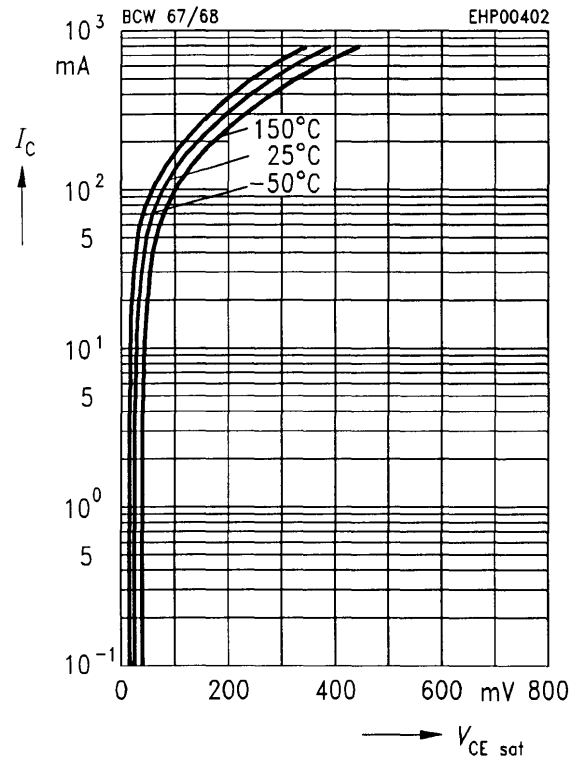

DC current gain $h_{FE} = f(I_C)$

$V_{CE} = 1 V$

