

LOW-POWER DUAL C-MOS OPERATIONAL AMPLIFIER

■ GENERAL DESCRIPTION

The NJU7014, 15 and 16 are dual C-MOS operational amplifiers operated on a single-power-supply, low voltage and low operating current.

The input bias current is as low as than 1pA, consequently very small signal around the ground level can be amplified.

The minimum operating voltage is 1V and the output stage permits output signal to swing between both of the supply rails.

Furthermore, this series is packaged with a various small one therefore it can be especially applied to portable items.

■ PACKAGE OUTLINE

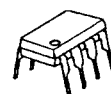

NJU701XD



NJU701XM



NJU701XV



NJU701XR

■ FEATURES

- Single-Power-Supply
- Wide Operating Voltage $V_{DD}=1\sim 5.5V$
- Wide Output Swing Range $V_{OM}=2.9V$ min @3.0V
- Low Operating Current
- Low Bias Current $I_{IB}=1pA$ typ
- Compensation Capacitor Incorporated
- Package Outline DIP-8/DMP-8/SSOP-8/VSP-8
- C-MOS Technology

■ PIN CONFIGURATION

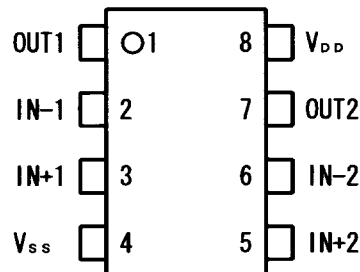

■ LINE-UP

(Ta=25°C, V_{DD}=3.0V, Per Circuit)

PARAMETER	NJU7014	NJU7015	NJU7016	UNIT
Operating Current	15	80	200	μA (typ)
Slew Rate	0.1	1.0	2.4	V/μs (typ)
Unity Gain Bandwidth	0.2	1.0	1.0	MHz (typ)

■ EQUIVALENT CIRCUIT

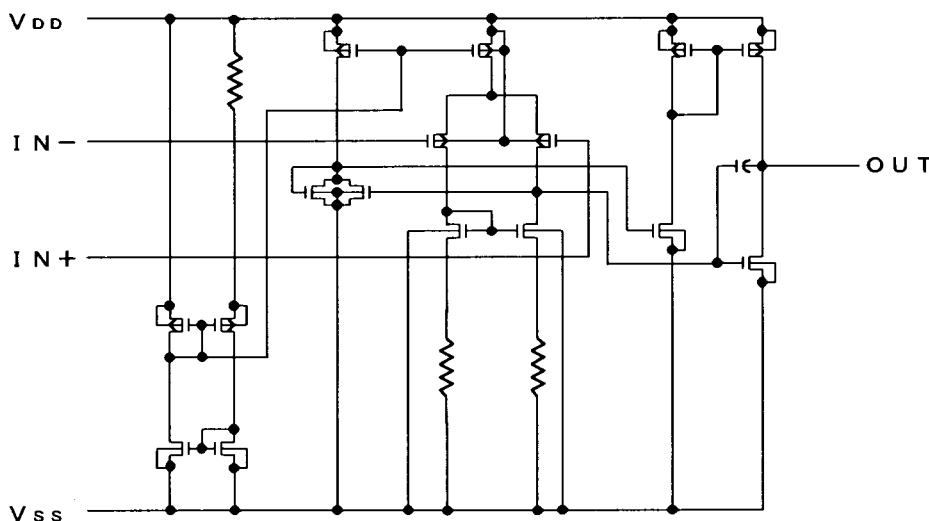

■ ABSOLUTE MAXIMUM RATINGS

(Ta=25°C)

PARAMETER	SYMBOL	RATINGS	UNIT
Supply Voltage	V_{DD}	7	V
Differential Input Voltage	V_{ID}	± 7 Note1	V
Common Mode Input Voltage	V_{IC}	- 0.3 ~ 7	V
Power Dissipation	P_D	500 (DIP-8) 300 (DMP-8) 250 (SSOP-8) 320 (VSP-8)	mW
Operating Temperature	T_{opr}	- 40 ~ + 85	°C
Storage Temperature	T_{stg}	- 55 ~ +125	°C

Note1) If the supply voltage (V_{DD}) is less than 7V, the input voltage must not over the V_{DD} level though 7V is limit specified.

Note2) Decoupling capacitor should be connected between V_{DD} and V_{SS} due to the stabilized operation for the circuit.

■ ELECTRICAL CHARACTERISTICS

NJU7014

 (Ta=25°C, $V_{DD}=3.0V$, $R_L=\infty$)

PARAMETER	SYMBOL	CONDITIONS	MIN	TYP	MAX	UNIT
Input Offset Voltage	V_{IO}	$V_{IN}=1/2V_{DD}$	—	—	10	mV
Input Offset Current	I_{IO}		—	1	—	pA
Input Bias Current	I_{IB}		—	1	—	pA
Input Impedance	R_{IN}		—	1	—	TΩ
Large Signal Voltage Gain	A_{VD}		60	70	—	dB
Input Common Mode Voltage Range	V_{ICM}		0~2.5	—	—	V
Maximum Output Swing Voltage	V_{OM1} V_{OM2}	$R_L=1M\Omega$ $R_L=1M\Omega$	$V_{DD}-0.1$ —	— —	— $V_{SS}+0.1$	V V
Common Mode Rejection Ratio	CMR	$V_{IN}=1/2V_{DD}$	55	65	—	dB
Supply Voltage Rejection Ratio	SVR	$V_{DD}=1.5\sim 5.5V$	60	70	—	dB
Operating Current	I_{DD}	Per Circuit	—	15	25	μA
Slew Rate	SR		—	0.1	—	V/μs
Unity Gain Bandwidth	Ft	$A_V=40dB$, $C_L=10pF$	—	0.2	—	MHz

Note3) The source current is less than 2.9μA (at $V_{OM}/R_L=2.9V/1M\Omega$).

NJU7015

 (Ta=25°C, V_{DD}=3.0V, R_L=∞)

PARAMETER	SYMBOL	CONDITIONS	MIN	TYP	MAX	UNIT
Input Offset Voltage	V _{IO}	V _{IN} =1/2V _{DD}	—	—	10	mV
Input Offset Current	I _{IO}		—	1	—	pA
Input Bias Current	I _{IB}		—	1	—	pA
Input Impedance	R _{IN}		—	1	—	TΩ
Large Signal Voltage Gain	A _{VD}		60	70	—	dB
Input Common Mode Voltage Range	V _{ICM}		0~2.5	—	—	V
Maximum Output Swing Voltage	V _{OM1}	R _L =100kΩ	V _{DD} -0.1	—	—	V
	V _{OM2}	R _L =100kΩ	—	—	V _{SS} +0.1	V
Common Mode Rejection Ratio	CMR	V _{IN} =1/2V _{DD}	55	65	—	dB
Supply Voltage Rejection Ratio	SVR	V _{DD} =1.5~5.5V	60	70	—	dB
Operating Current	I _{DD}	Per Circuit	—	80	160	uA
Slew Rate	SR		—	1.0	—	V/us
Unity Gain Bandwidth	Ft	A _v =40dB, C _L =10pF	—	1.0	—	MHz

 Note4) The source current is less than 29uA (at V_{OM}/R_L=2.9V/100kΩ).

NJU7016

 (Ta=25°C, V_{DD}=3.0V, R_L=∞)

PARAMETER	SYMBOL	CONDITIONS	MIN	TYP	MAX	UNIT
Input Offset Voltage	V _{IO}	V _{IN} =1/2V _{DD}	—	—	10	mV
Input Offset Current	I _{IO}		—	1	—	pA
Input Bias Current	I _{IB}		—	1	—	pA
Input Impedance	R _{IN}		—	1	—	TΩ
Large Signal Voltage Gain	A _{VD}		60	70	—	dB
Input Common Mode Voltage Range	V _{ICM}		0~2.5	—	—	V
Maximum Output Swing Voltage	V _{OM1}	R _L =50kΩ	V _{DD} -0.1	—	—	V
	V _{OM2}	R _L =50kΩ	—	—	V _{SS} +0.1	V
Common Mode Rejection Ratio	CMR	V _{IN} =1/2V _{DD}	55	65	—	dB
Supply Voltage Rejection Ratio	SVR	V _{DD} =1.5~5.5V	60	70	—	dB
Operating Current	I _{DD}	Per Circuit	—	200	400	uA
Slew Rate	SR		—	1.0	—	V/us
Unity Gain Bandwidth	Ft	A _v =40dB, C _L =10pF	—	1.0	—	MHz

 Note5) The source current is less than 58uA (at V_{OM}/R_L=2.9V/50kΩ).

■ TYPICAL CHARACTERISTICS

(1) NJU7014

Output Voltage vs. Output Current (SOURCE)

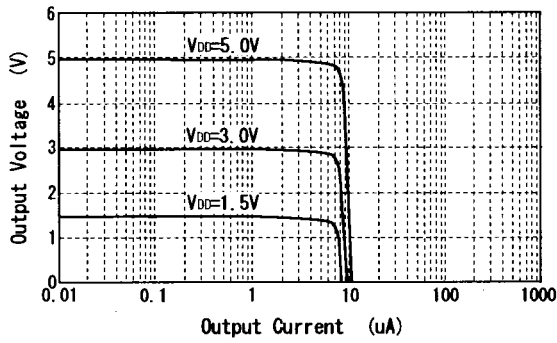

Output Voltage vs. Output Current (SINK)

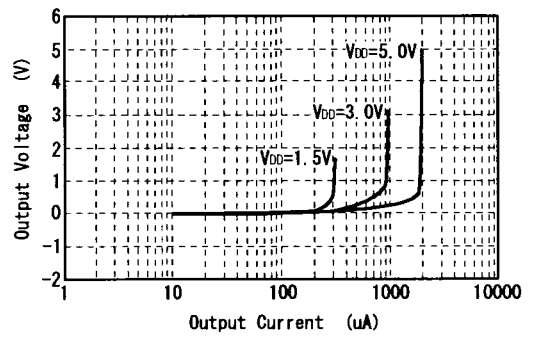

Operating Current vs. Operating Voltage

V_{IN}=0.1V

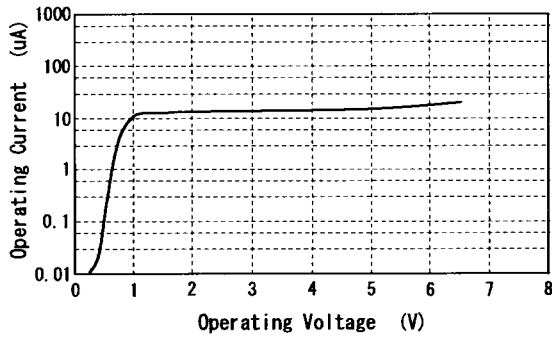

Output Current vs. Operating Voltage

V_{IN}=0.1V

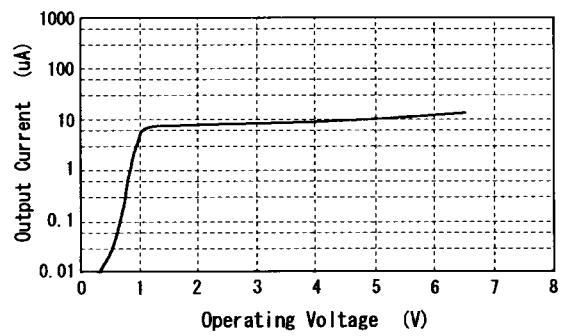

Maximum Output Swing Voltage vs. Load Resistance

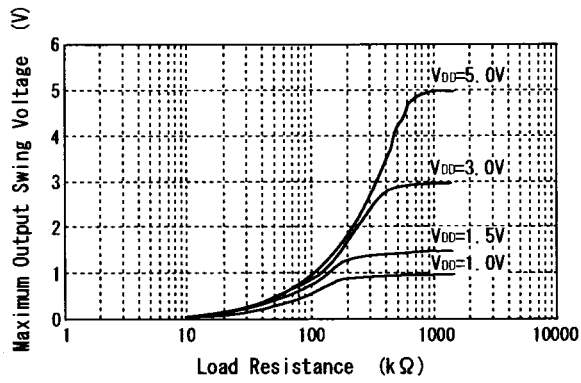

Maximum Output Swing Voltage vs. Frequency

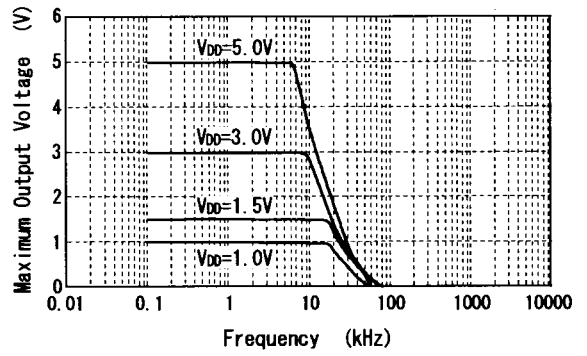

Voltage Gain-Phase vs. Frequency

V_{DD}=3V, R_s=1kΩ, A_v=40dB

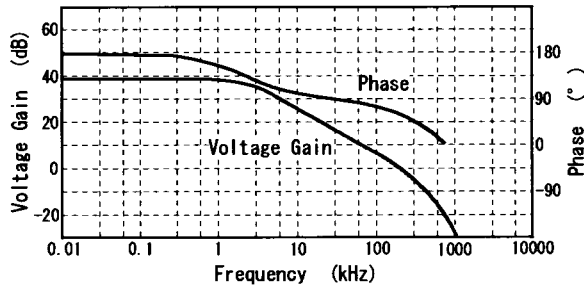

(2) NJU7015

Output Voltage vs. Output Current (SOURCE)

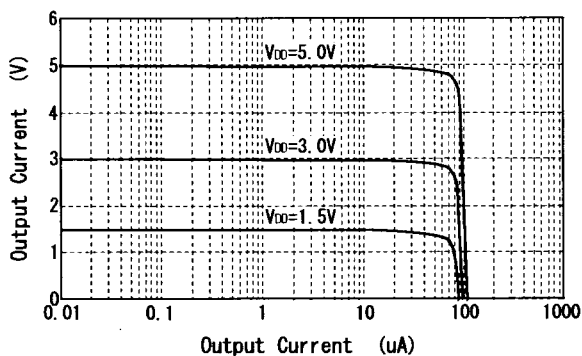

Output Voltage vs. Output Current (SINK)

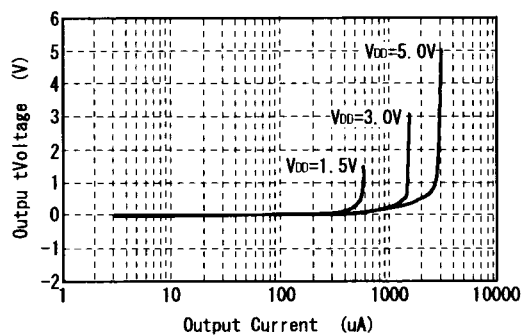

Operating Current vs. Operating Voltage

V_{IN}=0.1V

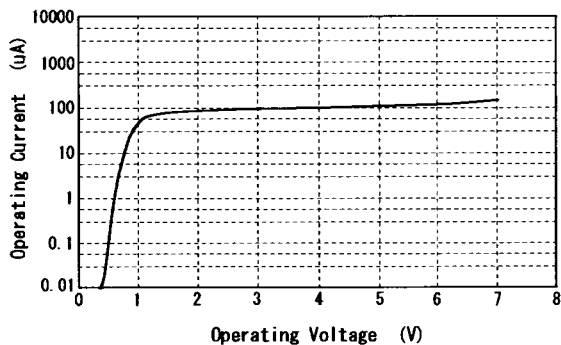

Output Current vs. Operating Voltage

V_{IN}=0.1V

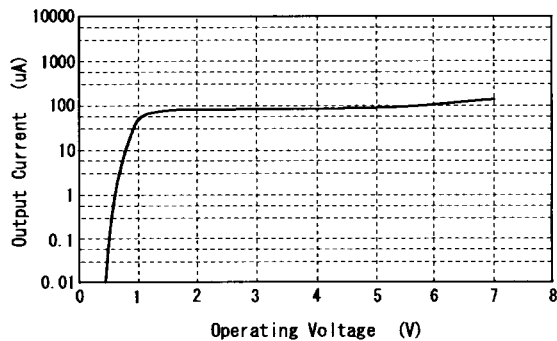

Maximum Output Swing Voltage vs. Load Resistance

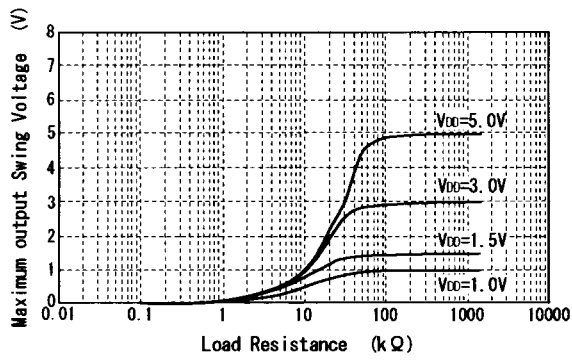

Maximum Output Swing Voltage vs. Frequency

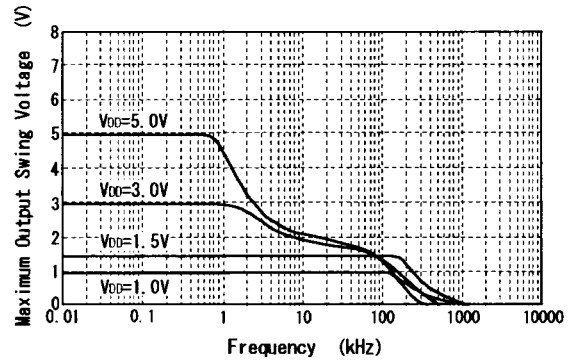

Voltage Gain-Phase vs. Frequency

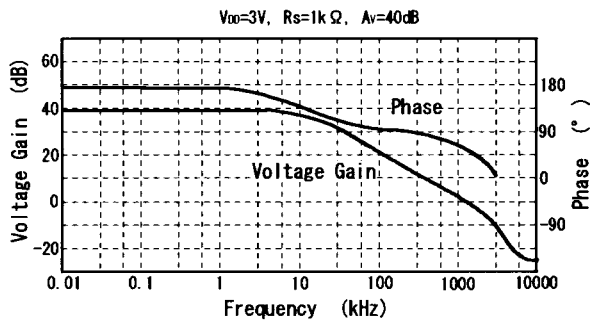

(3) NJU7016

Output Voltage vs. Output Current (SOURCE)

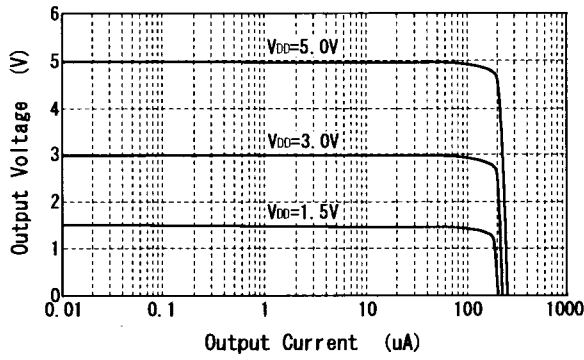

Output Voltage vs. Output Current (SINK)

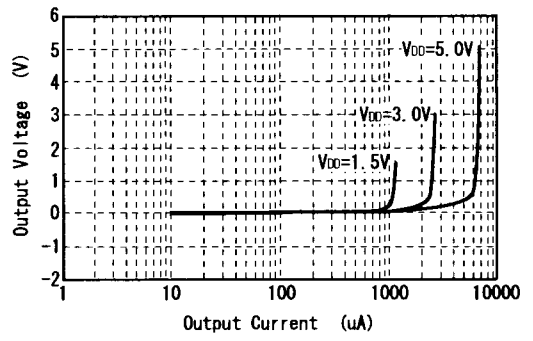

Operating Current vs. Operating Voltage

V_{IN}=0.1V

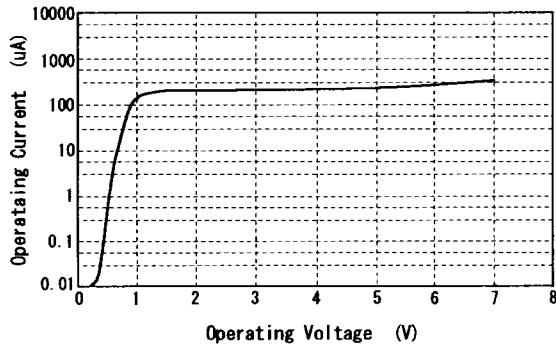

Output Current vs. Operating Voltage

V_{IN}=0.1V

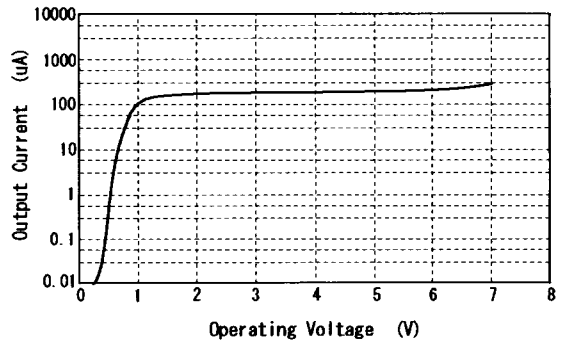

Maximum Output Swing Voltage vs. Load Resistance

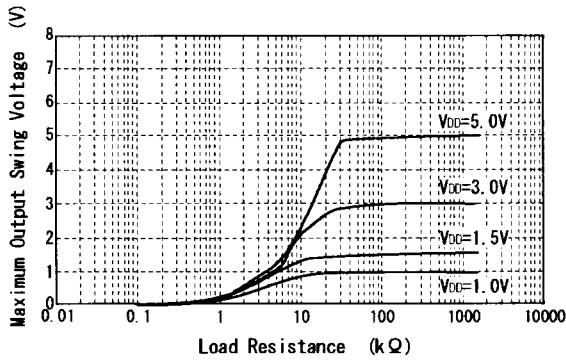

Maximum Output Swing Voltage vs. Frequency

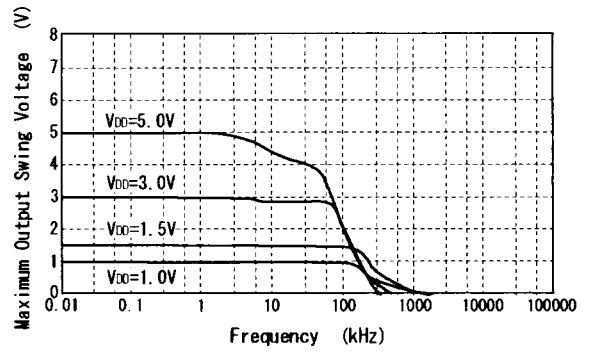

Voltage Gain-Phase vs. Frequency

$V_{DD}=3V, R_s=1k\Omega, A_v=40dB$

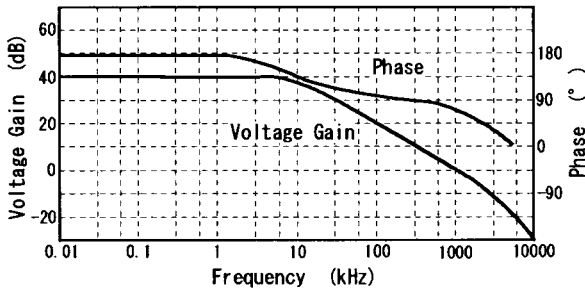

[CAUTION]

The specifications on this data book are only given for information, without any guarantee as regards either mistakes or omissions. The application circuits in this data book are described only to show representative usages of the product and not intended for the guarantee or permission of any right including the industrial rights.