

# FDC6330L

## Integrated Load Switch

### General Description

This device is particularly suited for compact power management in portable electronic equipment where 3V to 20V input and 2.3A output current capability are needed. This load switch integrates a small N-Channel power MOSFET (Q1) which drives a large P-Channel power MOSFET (Q2) in one tiny SuperSOT™-6 package.

### Applications

- Power management
- Load actuation

### Features

- $V_{DROP} = 0.2V @ V_{IN} = 12V, I_L = 2.5 A. R_{(ON)} = 0.08 \Omega$   
 $V_{DROP} = 0.2V @ V_{IN} = 5V, I_L = 1.6 A. R_{(ON)} = 0.125 \Omega.$
- Control MOSFET (Q1) includes Zener protection for ESD ruggedness (>6kV Human Body Model).
- High performance PowerTrench™ technology for extremely low on-resistance.
- SuperSOT™-6 package design using copper lead frame for superior thermal and electrical capabilities.



SuperSOT™-6

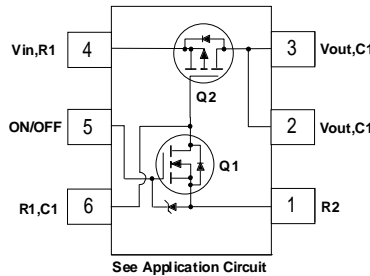

See Application Circuit

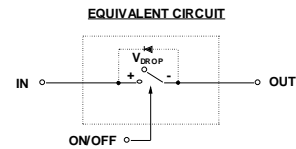

### Absolute Maximum Ratings T<sub>A</sub>=25°C unless otherwise noted

| Symbol                            | Parameter   | Ratings     | Units |
|-----------------------------------|---|-------------|-------|
| V <sub>IN</sub>                   | Input Voltage Range (Note 1)  | 3 - 20      | V     |
| V <sub>ON/OFF</sub>               | On/Off Voltage Range  | 1.5 - 8     | V     |
| I <sub>D</sub>                    | Load Current - Continuous (Note 2)  | 2.3         | A     |
|                                   |   | 10          |       |
| P <sub>D</sub>                    | Maximum Power Dissipation (Note 1)  | 0.7         | W     |
| T <sub>J</sub> , T <sub>stg</sub> | Operating and Storage Temperature Range                                       | -55 to +150 | °C    |
| ESD                               | Electrostatic Discharge Rating MIL-STD-883D Human-Body-Model (100pf/1500 Ohm) | 6           | kV    |

### Thermal Characteristics

|                  |  |     |      |
|------------------|--|-----|------|
| R <sub>θJA</sub> | Thermal Resistance, Junction-to-Ambient (Note 2) | 180 | °C/W |
| R <sub>θJC</sub> | Thermal Resistance, Junction-to-Case (Note 2)    | 60  | °C/W |

### Package Marking and Ordering Information

| Device Marking         | Device   | Reel Size | Tape width | Quantity   |
|------------------------|----------|-----------|------------|------------|
| .330 (. Denotes pin 1) | FDC6330L | 7"        | 8mm        | 3000 units |

### Electrical Characteristics T<sub>A</sub>=25°C unless otherwise noted

| Symbol  | Parameter                             | Test Conditions   | Min | Typ            | Max           | Units |
|---|---------------------------------------|---|-----|----------------|---------------|-------|
| <b>OFF Characteristics</b>                        |                                       |   |     |                |               |       |
| I <sub>FL</sub>                                   | Leakage Current                       | V <sub>IN</sub> = 20 V, V <sub>ON/OFF</sub> = 250 μA  |     |                | 1             | μA    |
| <b>ON Characteristics</b> <small>(Note 3)</small> |                                       |   |     |                |               |       |
| V <sub>DROP</sub>                                 | Conduction Voltage                    | V <sub>IN</sub> = 12 V, V <sub>ON/OFF</sub> = 3.3 V, I <sub>L</sub> = 2.5 A                         |     |                | 0.2           | V     |
|   |                                       | V <sub>IN</sub> = 5 V, V <sub>ON/OFF</sub> = 3.3 V, I <sub>L</sub> = 1.6 A                          |     |                | 0.2           | V     |
| R <sub>(ON)</sub>                                 | Q <sub>2</sub> - Static On-Resistance | V <sub>GS</sub> = -12 V, I <sub>D</sub> = -2.3 A<br>V <sub>GS</sub> = -5 V, I <sub>D</sub> = -1.9 A |     | 0.054<br>0.081 | 0.08<br>0.125 | Ω     |
| I <sub>L</sub>                                    | Load Current                          | V <sub>DROP</sub> = 0.2 V, V <sub>IN</sub> = 12 V, V <sub>ON/OFF</sub> = 3.3 V                      | 2.5 |                |               | A     |
|   |                                       | V <sub>DROP</sub> = 0.2 V, V <sub>IN</sub> = 5 V, V <sub>ON/OFF</sub> = 3.3 V                       | 1.6 |                |               |       |

**Notes:**

1. Range of V<sub>in</sub> can be up to 30V, but R<sub>1</sub> and R<sub>2</sub> must be scaled such that V<sub>GS</sub> of Q2 does not exceed 20V.
2. R<sub>θJA</sub> is the sum of the junction-to-case and case-to-ambient thermal resistance where the case thermal reference is defined as the solder mounting surface of the drain pins. R<sub>θJC</sub> is guaranteed by design while R<sub>θJA</sub> is determined by the user's board design.
3. Pulse Test: Pulse Width ≤ 300μs, Duty Cycle ≤ 2.0%.

### FDC6330L Load Switch Application

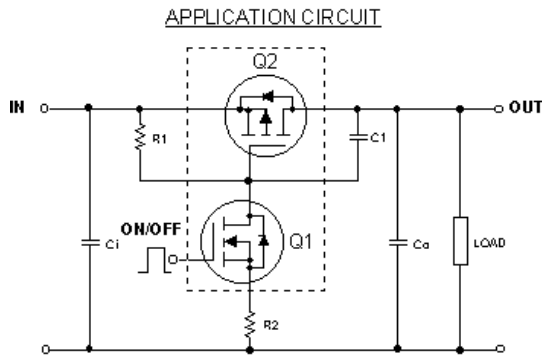

**External Component Recommendation:**

- For applications where Co ≤ 1μF.
- For slew rate control, select R2 in the range of 1k - 4.7kΩ .
- For additional in-rush current control, C1 ≤ 1000pF can be added.
- Select R1 so that the R1/R2 ratio ranges from 10 - 100. R1 is required to turn Q2 off.

**Typical Characteristics** (continued)

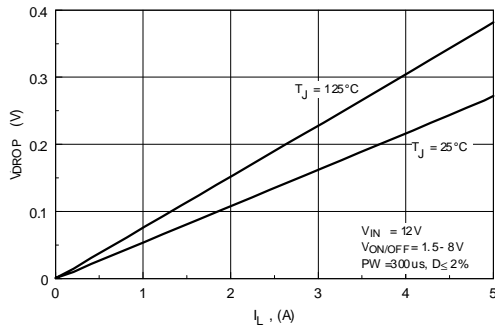

**Figure 1. Conduction Voltage Drop Variation with Load Current.**

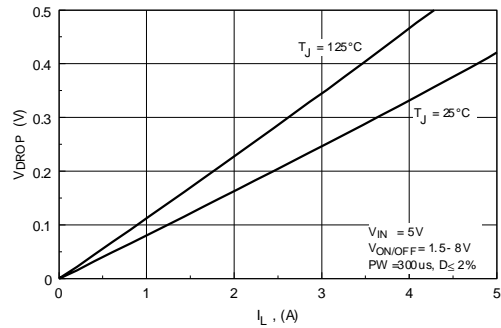

**Figure 2. Conduction Voltage Drop Variation with Load Current.**

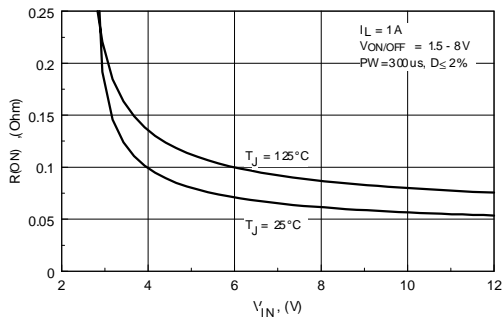

**Figure 3. On-Resistance Variation with Input Voltage.**

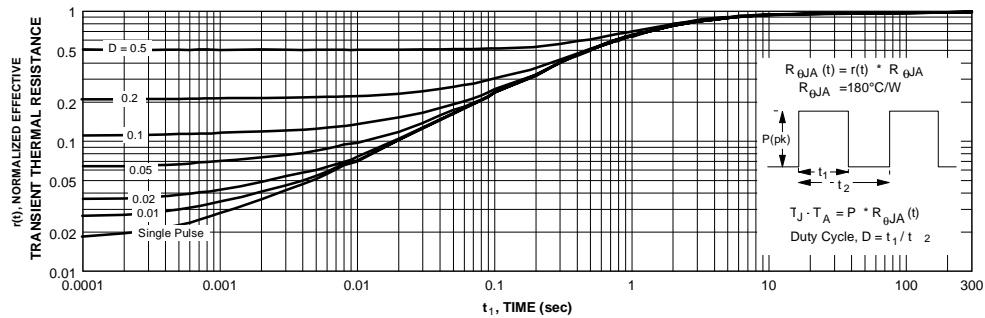
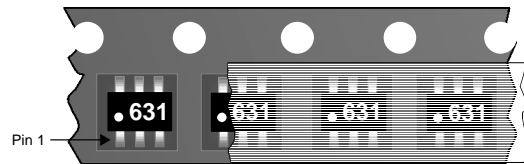
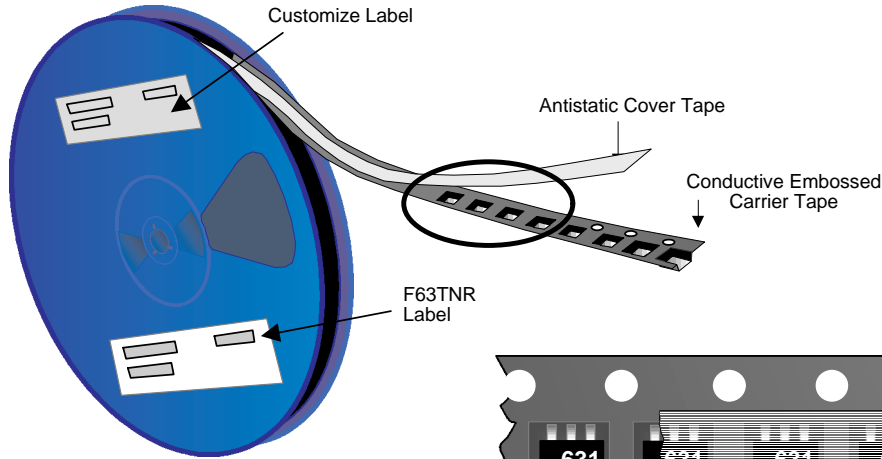

**Figure 4. Transient Thermal Response Curve.**

Thermal characterization performed using the conditions described in Note 2. Transient thermal response will change depending on the circuit board design.

# SuperSOT™-6 Tape and Reel Data and Package Dimensions

**SSOT-6 Packaging**  
Configuration: Figure 1.0



**SSOT-6 Unit Orientation**

| SSOT-6 Packaging Information |                         |            |
|------------------------------|-------------------------|------------|
| Packaging Option             | Standard (no flow code) | D87Z       |
| Packaging type               | TNR                     | TNR        |
| Qty per Reel/Tube/Bag        | 3,000                   | 10,000     |
| Reel Size                    | 7" Dia                  | 13"        |
| Box Dimension (mm)           | 184x187x47              | 343x343x64 |
| Max qty per Box              | 9,000                   | 20,000     |
| Weight per unit (gm)         | 0.0158                  | 0.0158     |
| Weight per Reel (kg)         | 0.1440                  | 0.4700     |
| Note/Comments                |                         |            |

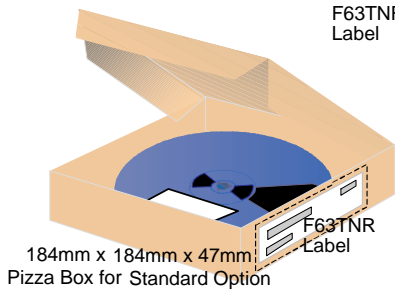
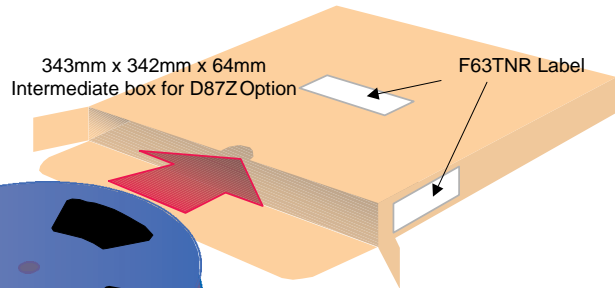

**F63TNR Label sample**



**SSOT-6 Tape Leader Trailer Configuration: Figure 2.0**

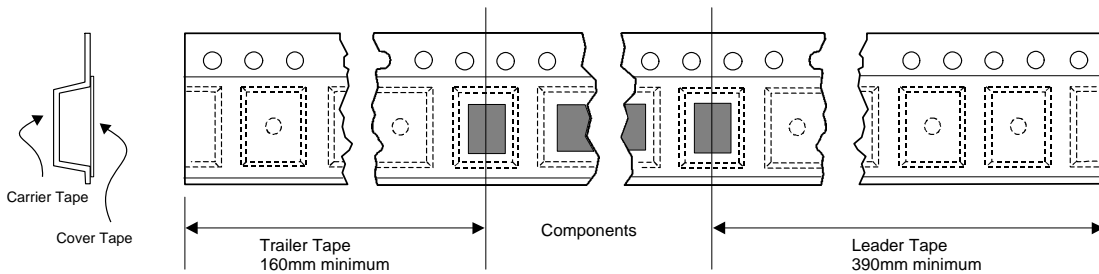

# SuperSOT™-6 Tape and Reel Data and Package Dimensions, continued

## SSOT-6 Embossed Carrier Tape Configuration: Figure 3.0

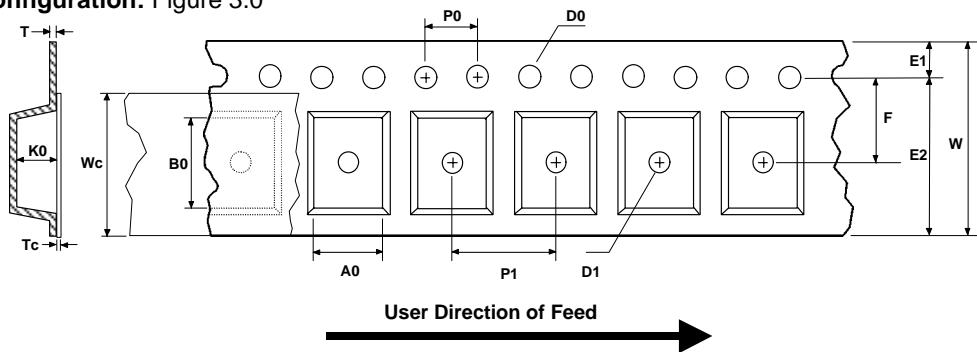

| Dimensions are in millimeter |              |              |            |              |               |              |          |              |            |            |              |                |            |              |
|------------------------------|--------------|--------------|------------|--------------|---------------|--------------|----------|--------------|------------|------------|--------------|----------------|------------|--------------|
| Pkg type                     | A0           | B0           | W          | D0           | D1            | E1           | E2       | F            | P1         | P0         | K0           | T              | Wc         | Tc           |
| SSOT-6 (8mm)                 | 3.23 +/-0.10 | 3.18 +/-0.10 | 8.0 +/-0.3 | 1.55 +/-0.05 | 1.00 +/-0.125 | 1.75 +/-0.10 | 6.25 min | 3.50 +/-0.05 | 4.0 +/-0.1 | 4.0 +/-0.1 | 1.37 +/-0.10 | 0.255 +/-0.150 | 5.2 +/-0.3 | 0.06 +/-0.02 |

Notes: A0, B0, and K0 dimensions are determined with respect to the EIA/Jedec RS-481 rotational and lateral movement requirements (see sketches A, B, and C).

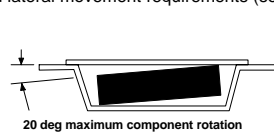

Sketch A (Side or Front Sectional View)  
Component Rotation

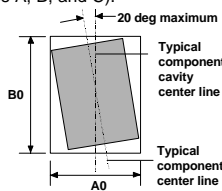

Sketch B (Top View)  
Component Rotation

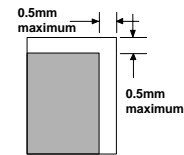

Sketch C (Top View)  
Component lateral movement

## SSOT-6 Reel Configuration: Figure 4.0

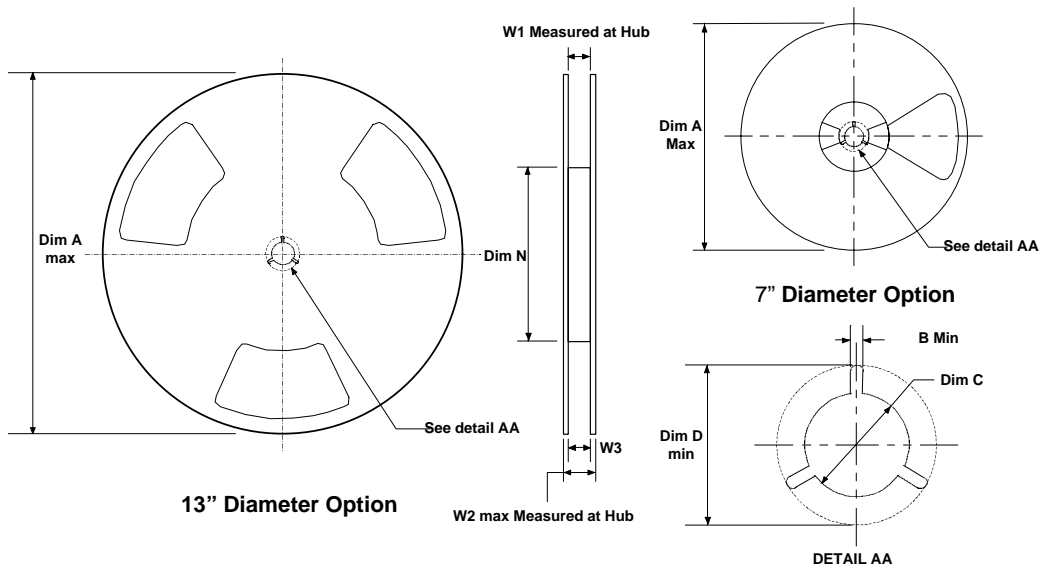

| Dimensions are in inches and millimeters |             |               |              |                                   |               |             |                                   |               |                             |
|--|-------------|---------------|--------------|-----------------------------------|---------------|-------------|-----------------------------------|---------------|-----------------------------|
| Tape Size                                | Reel Option | Dim A         | Dim B        | Dim C                             | Dim D         | Dim N       | Dim W1                            | Dim W2        | Dim W3 (LSL-USL)            |
| 8mm                                      | 7" Dia      | 7.00<br>177.8 | 0.059<br>1.5 | 512 +0.020/-0.008<br>13 +0.5/-0.2 | 0.795<br>20.2 | 2.165<br>55 | 0.331 +0.059/-0.000<br>8.4 +1.5/0 | 0.567<br>14.4 | 0.311 - 0.429<br>7.9 - 10.9 |
| 8mm                                      | 13" Dia     | 13.00<br>330  | 0.059<br>1.5 | 512 +0.020/-0.008<br>13 +0.5/-0.2 | 0.795<br>20.2 | 4.00<br>100 | 0.331 +0.059/-0.000<br>8.4 +1.5/0 | 0.567<br>14.4 | 0.311 - 0.429<br>7.9 - 10.9 |

**SuperSOT™-6 Tape and Reel Data and Package Dimensions, continued**

**SuperSOT™-6 (FS PKG Code 31, 33)**

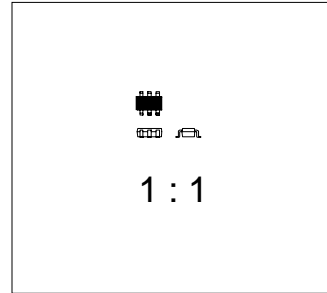
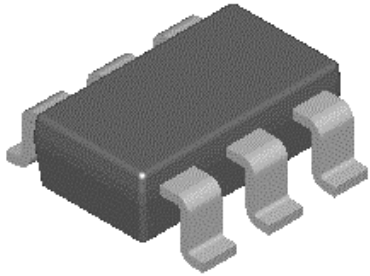

Scale 1:1 on letter size paper

Dimensions shown below are in:  
inches [millimeters]

Part Weight per unit (gram): 0.0158

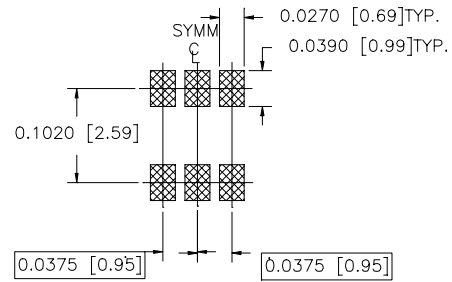
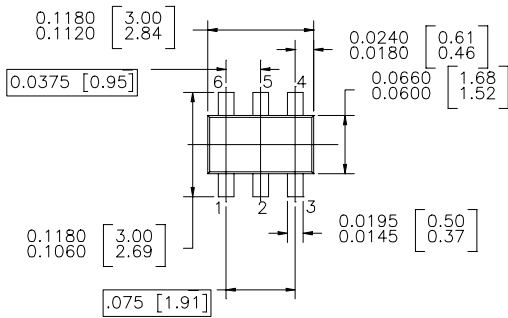

LAND PATTERN RECOMMENDATION

CONTROLLING DIMENSION IS INCH  
VALUES IN [ ] ARE MILLIMETERS

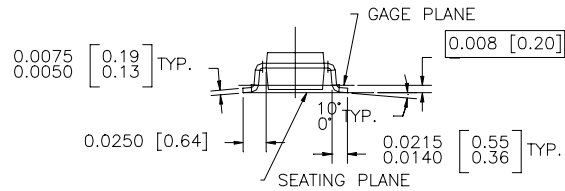
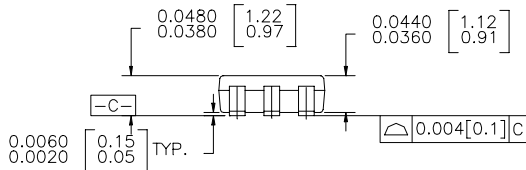

SUPER SOT 6 LEADS

NOTES : UNLESS OTHERWISE SPECIFIED

1.0 STANDARD LEAD FINISH : 150 MICRONS 93.81 MICROMETERS)  
MINIMUM TIN / LEAD (SOLDER) ON COPPER.

2.0 NO JEDEC REGISTRATION AS OF JULY 1996

## TRADEMARKS

The following are registered and unregistered trademarks Fairchild Semiconductor owns or is authorized to use and is not intended to be an exhaustive list of all such trademarks.

|                      |               |
|----------------------|---------------|
| ACEx™                | ISOPLANAR™    |
| CoolFET™             | MICROWIRE™    |
| CROSSVOLT™           | POP™          |
| E <sup>2</sup> CMOS™ | PowerTrench™  |
| FACT™                | QS™           |
| FACT Quiet Series™   | Quiet Series™ |
| FAST®                | SuperSOT™-3   |
| FASTr™               | SuperSOT™-6   |
| GTO™                 | SuperSOT™-8   |
| HiSeC™               | TinyLogic™    |

## DISCLAIMER

FAIRCHILD SEMICONDUCTOR RESERVES THE RIGHT TO MAKE CHANGES WITHOUT FURTHER NOTICE TO ANY PRODUCTS HEREIN TO IMPROVE RELIABILITY, FUNCTION OR DESIGN. FAIRCHILD DOES NOT ASSUME ANY LIABILITY ARISING OUT OF THE APPLICATION OR USE OF ANY PRODUCT OR CIRCUIT DESCRIBED HEREIN; NEITHER DOES IT CONVEY ANY LICENSE UNDER ITS PATENT RIGHTS, NOR THE RIGHTS OF OTHERS.

## LIFE SUPPORT POLICY

FAIRCHILD'S PRODUCTS ARE NOT AUTHORIZED FOR USE AS CRITICAL COMPONENTS IN LIFE SUPPORT DEVICES OR SYSTEMS WITHOUT THE EXPRESS WRITTEN APPROVAL OF FAIRCHILD SEMICONDUCTOR CORPORATION. As used herein:

1. Life support devices or systems are devices or systems which, (a) are intended for surgical implant into the body, or (b) support or sustain life, or (c) whose failure to perform when properly used in accordance with instructions for use provided in the labeling, can be reasonably expected to result in significant injury to the user.
2. A critical component is any component of a life support device or system whose failure to perform can be reasonably expected to cause the failure of the life support device or system, or to affect its safety or effectiveness.

## PRODUCT STATUS DEFINITIONS

### Definition of Terms

| Datasheet Identification | Product Status         | Definition  |
|--------------------------|------------------------|---|
| Advance Information      | Formative or In Design | This datasheet contains the design specifications for product development. Specifications may change in any manner without notice.  |
| Preliminary              | First Production       | This datasheet contains preliminary data, and supplementary data will be published at a later date. Fairchild Semiconductor reserves the right to make changes at any time without notice in order to improve design. |
| No Identification Needed | Full Production        | This datasheet contains final specifications. Fairchild Semiconductor reserves the right to make changes at any time without notice in order to improve design.   |
| Obsolete                 | Not In Production      | This datasheet contains specifications on a product that has been discontinued by Fairchild semiconductor. The datasheet is printed for reference information only.   |