

May 1999

**OBSOLETE PRODUCT
NO RECOMMENDED REPLACEMENT**
Call Central Applications 1-800-442-7747
or email: centapp@harris.com

TV Sync/AGC/Horizontal Signal Processor

Features

- Horizontal Oscillator with AFC
- Sync Separator with Noise Immunity
- Strobed AGC System
- IF AGC Output
- Delayed Outputs for Forward or Reverse AGC Tuners
- Internal Noise Threshold
- High-Impedance Video Input
- Choice of Dual External Time Constants for Sync Separator Noise Immunity
- RF AGC Delay Externally Controlled
- Output Short-Circuit Protection

Description

The CA3154 is a monolithic integrated circuit TV signal processor designed for use in color or monochrome receivers. Circuit functions include a horizontal oscillator with AFC, a sync separator, and a keyed AGC system. The AGC system provides output signals for IF (reverse) and tuner (forward and/or reverse). The wide frequency-range horizontal oscillator has high stability at 503.5kHz. When the CA3154 is used in conjunction with horizontal/vertical countdown circuits, the need for horizontal and vertical hold controls is eliminated.

Part Number Information

PART NUMBER	TEMP. RANGE (°C)	PACKAGE	PKG. NO.
CA3154E	-40 to 85	16 Ld PDIP	E16.3

Pinout

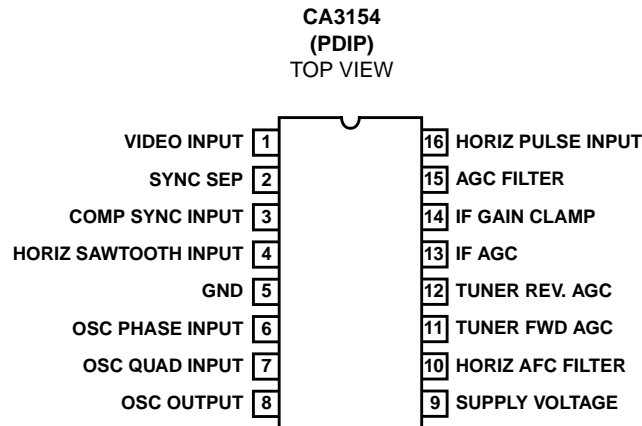

CA3154

Absolute Maximum Ratings

DC Supply Voltage (V+ to V-) 15V

Operating Conditions

Temperature Range -40°C to 85°C

Thermal Information

Thermal Resistance (Typical, Note 1)

θ_{JA} (°C/W)

PDIP Package 80

Maximum Junction Temperature (Plastic Package) 150°C

Maximum Storage Temperature Range -65°C to 150°C

Maximum Lead Temperature (Soldering 10s) 300°C

CAUTION: Stresses above those listed in "Absolute Maximum Ratings" may cause permanent damage to the device. This is a stress only rating and operation of the device at these or any other conditions above those indicated in the operational sections of this specification is not implied.

NOTE:

1. θ_{JA} is measured with the component mounted on an evaluation PC board in free air.

Electrical Specifications Terminal 5 to GND, and Terminal 9 to +12V, Unless Otherwise Specified

PARAMETER	SYMBOL	TEST CONDITIONS (TERMINALS CONNECTED AS SHOWN BELOW)	TEMP (°C)	MIN	TYP	MAX	UNITS
Power Supply Current	I_g	Measure (9)	25	10	-	22	mA
Video Inverter Voltage	V_2	(1) to +4V, (2) 12k Ω to GND, (3) 27k Ω to GND, Measure (2)	25	5.2	-	6.4	V
Sync Separator High Output Voltage	V_{3H}	(1) to +4V, (2) 12k Ω to GND, (3) 27k Ω to GND, Measure (2)	25	10.7	-	-	V
Sync Separator Low Output Voltage	V_{3L}	(1) to +4V, (3) 27k Ω to GND, Measure (3)	25	-	-	1.3	V
Video Noise Clamp Voltage	V_3 Clamp	(1) to +3.1V, (3) 27k Ω to GND, Measure (3)	25	10.7	-	-	V
AGC Discharge Current	I_{15} Discharge	(1) to +4.4V, (2) 10k Ω to GND, (15) 470 Ω to +6V, (16) 27k Ω to 12V, Measure (15)	25	0.6	-	1.4	mA
AGC Charge Current	I_{15} Charge	(1) to +3.45V, Otherwise, Same as Above	25	-2.1	-	-4.8	mA
AGC Comparator Leakage	I_{15} Leakage	(1) to +3.45V, (2) 10k Ω to GND, (15) 4.7k Ω to +6V, Measure (15)	25	-20	-	20	μ A
AGC Threshold Voltage	V_{1TH}	Adj. (1) for $I_{15} = 0 \pm 0.1$ mA, (2) 10k Ω to GND, (15) 4.7k Ω to +6V, (16) 27k Ω to +12V, Measure (1)	25	3.8	4	4.3	V
Minimum IF AGC	V_{13L}	(11) 10k Ω to GND, (12) 10k Ω to +12V, (13) 22k Ω to +5V, (14) 1k Ω to +2.95V, (15) 1k Ω to +2.2V, Measure (13)	25	0.75	-	1.25	V
Forward Tuner AGC Leakage Current	I_{11} Leakage	(11) 10k Ω to GND, (12) 10k Ω to 12V, (13) 2.2k Ω to +5V, (14) 1k Ω to +2.95V, (15) 1k Ω to +5.3V, Measure (11)	25	-20	-	20	μ A
Reverse Tuner AGC Leakage	I_{12} Leakage	Same as Above, but Measure (12)	25	-10	-	10	μ A
IF AGC High Voltage	V_{13H}	Same as Above, but Measure (13)	25	3.65	-	4.15	V
Forward Tuner AGC Low Voltage	V_{11L}	(11) 3.6k Ω to GND, (12) 3.16k Ω to +12V, (13) 2.2k Ω to +5V, (14) 1k Ω to +2.95V, (15) 1k Ω to +7.9V, Measure (11)	25	0.8	-	3.2	V
Reverse Tuner AGC Low Voltage	V_{12L}	Same as Above, but Measure (12)	25	1.65	-	3.25	V
Maximum IF AGC Voltage	V_{13H}	(11) 10k Ω to GND, (12) 10k Ω to +12V, (13) 2.2k Ω to +5V, (14) 1k Ω to +2.95V, (15) 1k Ω to +7.9V, Measure (13)	25	4.85	-	5.2	V
Phase Detector Leakage Current	I_{10L}	(2) 10k Ω to GND, (3) to GND, (4) 5k Ω to +3.8V, (10) 10k Ω to +6V, Limit GND at (3) to 10s, Measure 10	25	-5	-	5	μ A

CA3154

Electrical Specifications Terminal 5 to GND, and Terminal 9 to +12V, Unless Otherwise Specified (Continued)

PARAMETER	SYMBOL	TEST CONDITIONS (TERMINALS CONNECTED AS SHOWN BELOW)	TEMP (°C)	MIN	TYP	MAX	UNITS
Phase Detector Bias Voltage	V_4		25	2.65	-	3.1	V
Oscillator Output Voltage	V_6	Connect Oscillator Loop Shown in Test Circuit to (6), (7), (8); (3) to GND for 10s Max, Measure (6)	25	0.6	-	1.6	V_{p-p}
Oscillator Free-Running Frequency	f_{6FR}	Same as Above	25	475	-	535	kHz
Oscillator Frequency High	f_{6H}	Connect Oscillator Circuit Shown in Test Circuit to (10), (7), (8); (2) 10k Ω to GND, (4) 5k Ω to +18V, Measure (6)	25	520	-	-	kHz
Oscillator Frequency Low	f_{6L}	Same as Above, Except (4) 5k Ω to +3.8V	25	-	-	485	kHz
Sync Separator Short Circuit	I_3 Max	(3) 10 Ω to GND for 10s Max	25	-	-	40	mA
Oscillator Output Short Circuit	I_8 Max	(8) 10 Ω to GND for 10s Max (3) 10 Ω to GND for 10s Max	25	-	-	130	mA

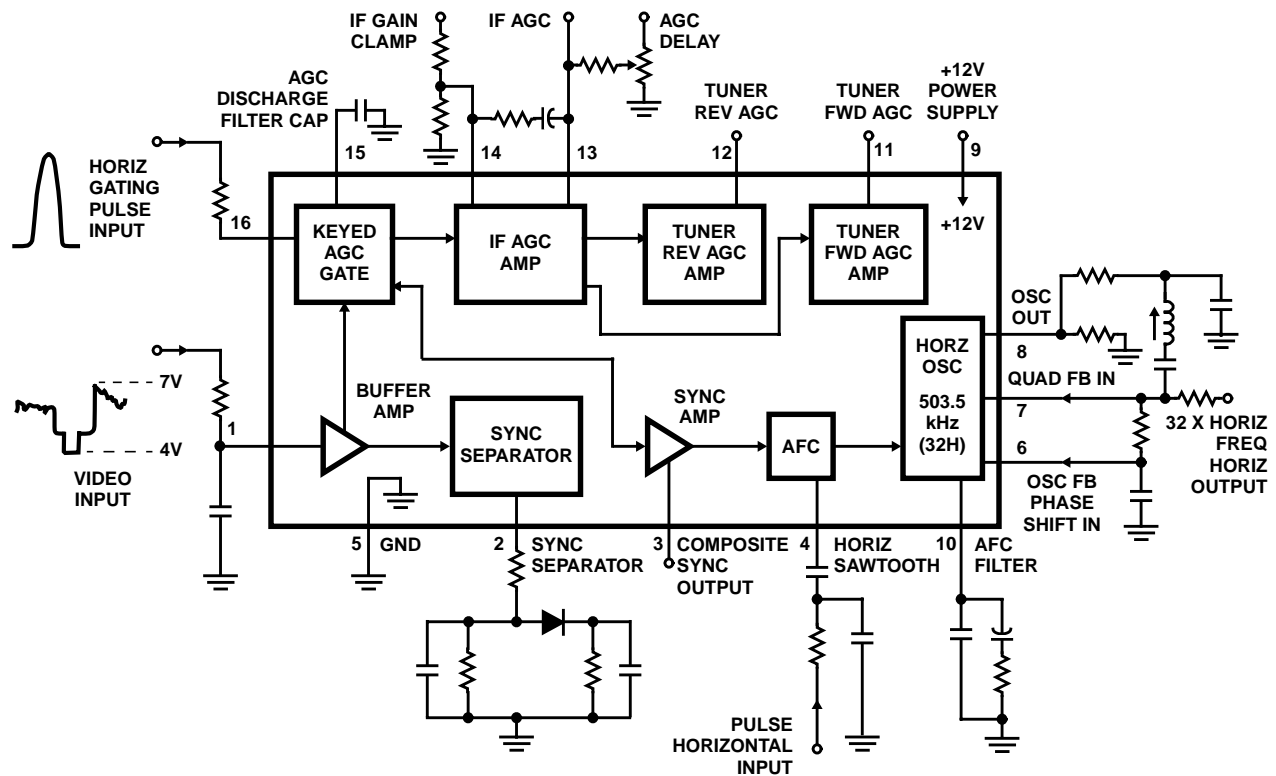
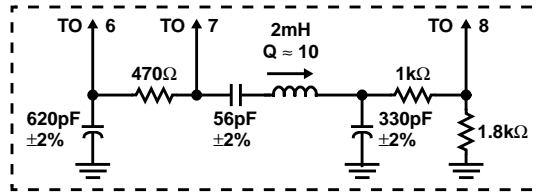

FIGURE 1. FUNCTIONAL BLOCK DIAGRAM OF CA3154

CA3154



NOTE: Oscillator loop to be used as indicated in the electrical characteristics chart, with coil adjusted for typical unit to 503.5kHz for f_{6FR} .

FIGURE 2. ELECTRICAL CHARACTERISTICS TEST CIRCUIT

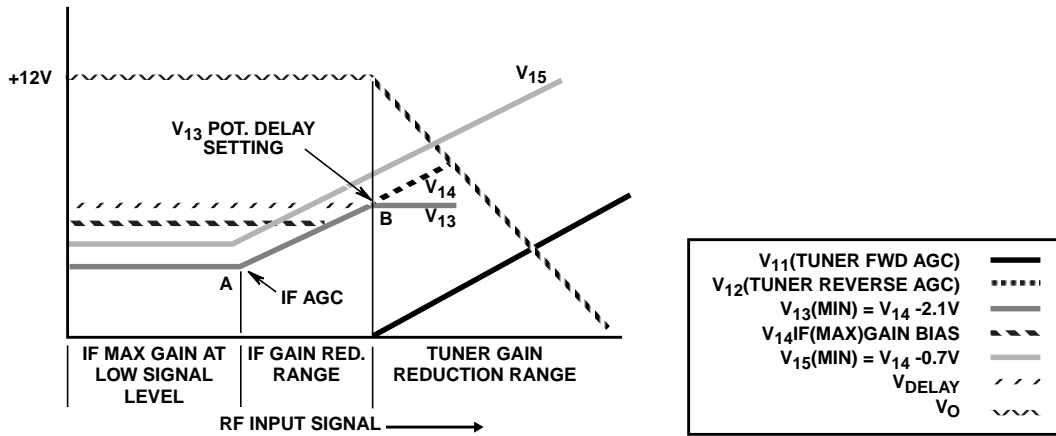

FIGURE 3. TYPICAL OPERATION OF AGC CIRCUITS USING THE CA3154

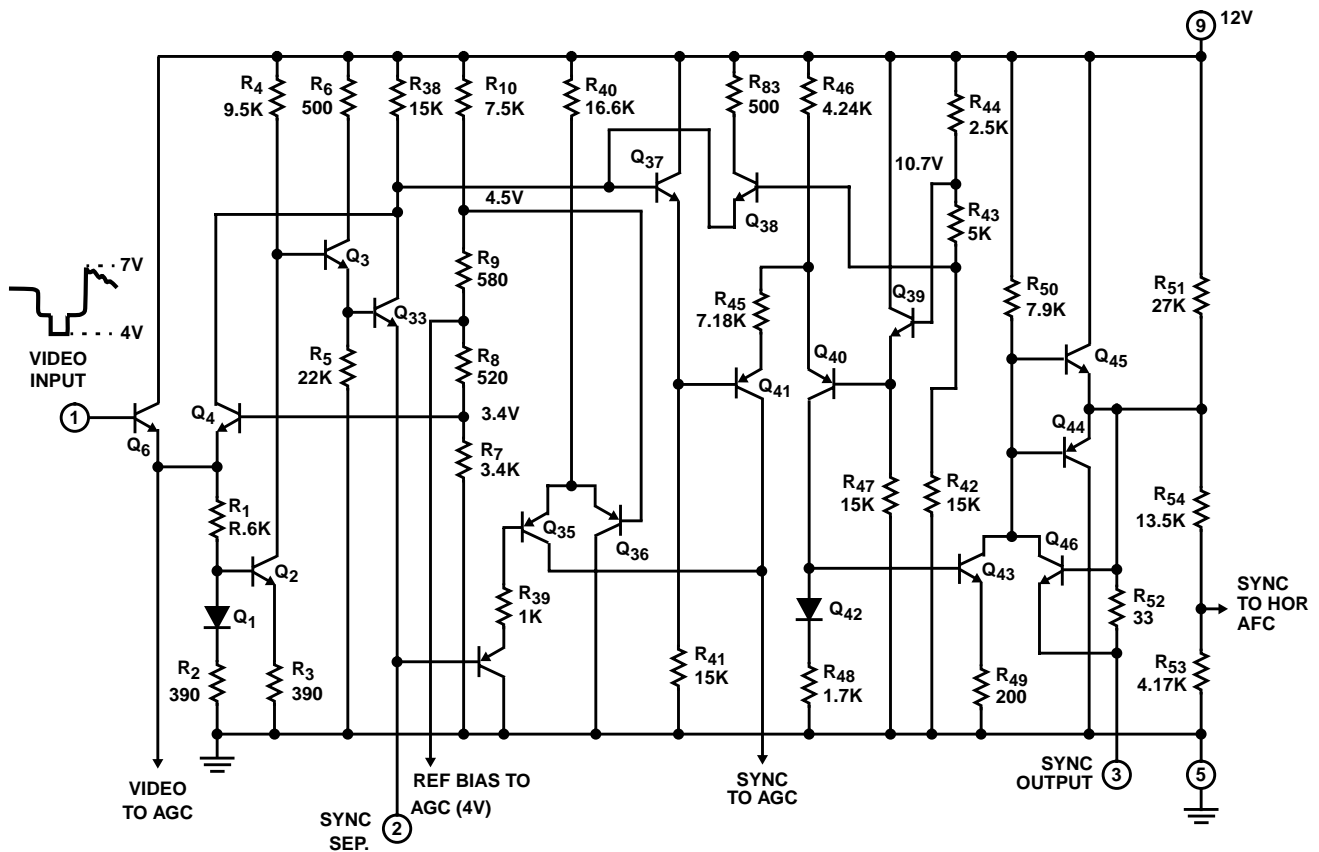

FIGURE 4. SCHEMATIC OF SYNC SEPARATOR SECTION OF THE CA3154

CA3154

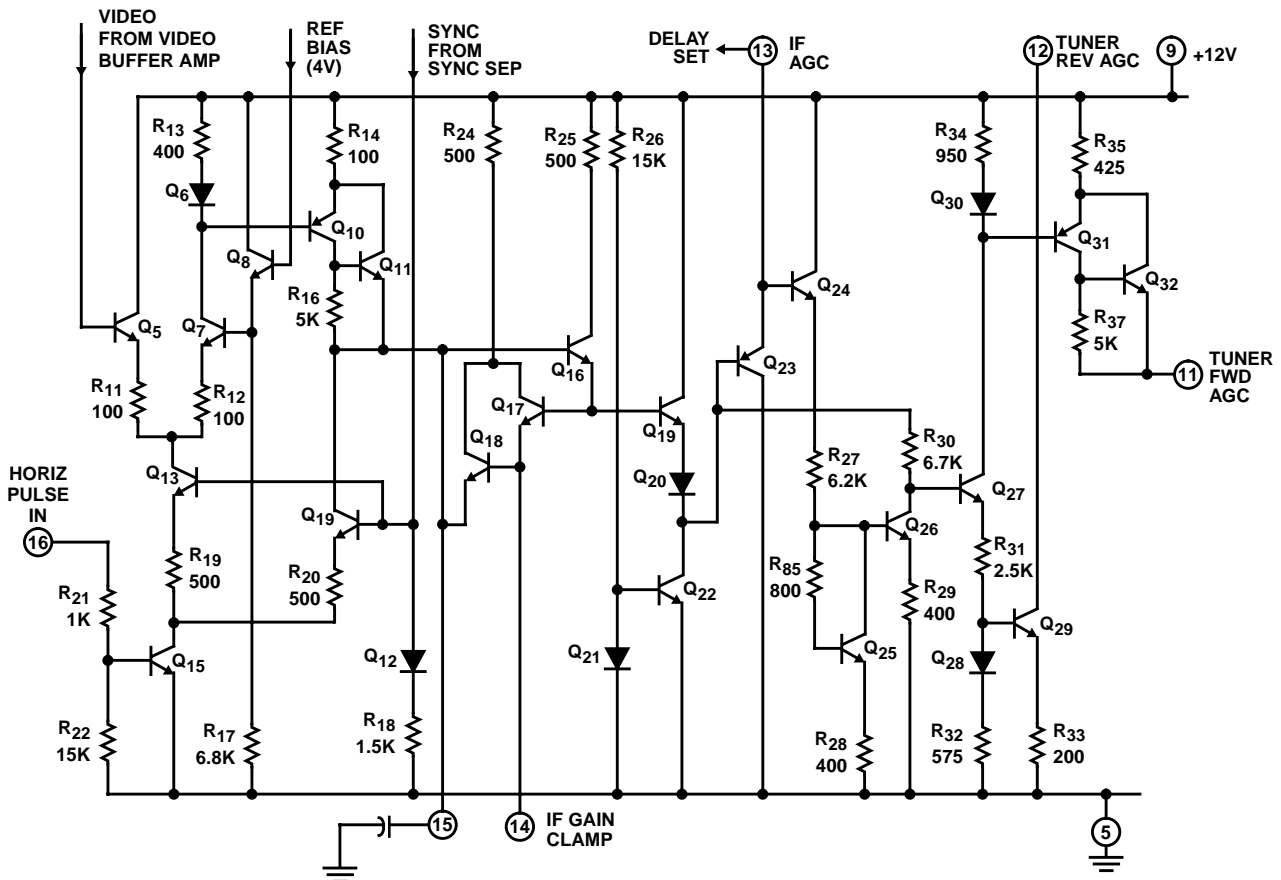

FIGURE 5. SCHEMATIC OF AGC SECTION OF THE CAA3154

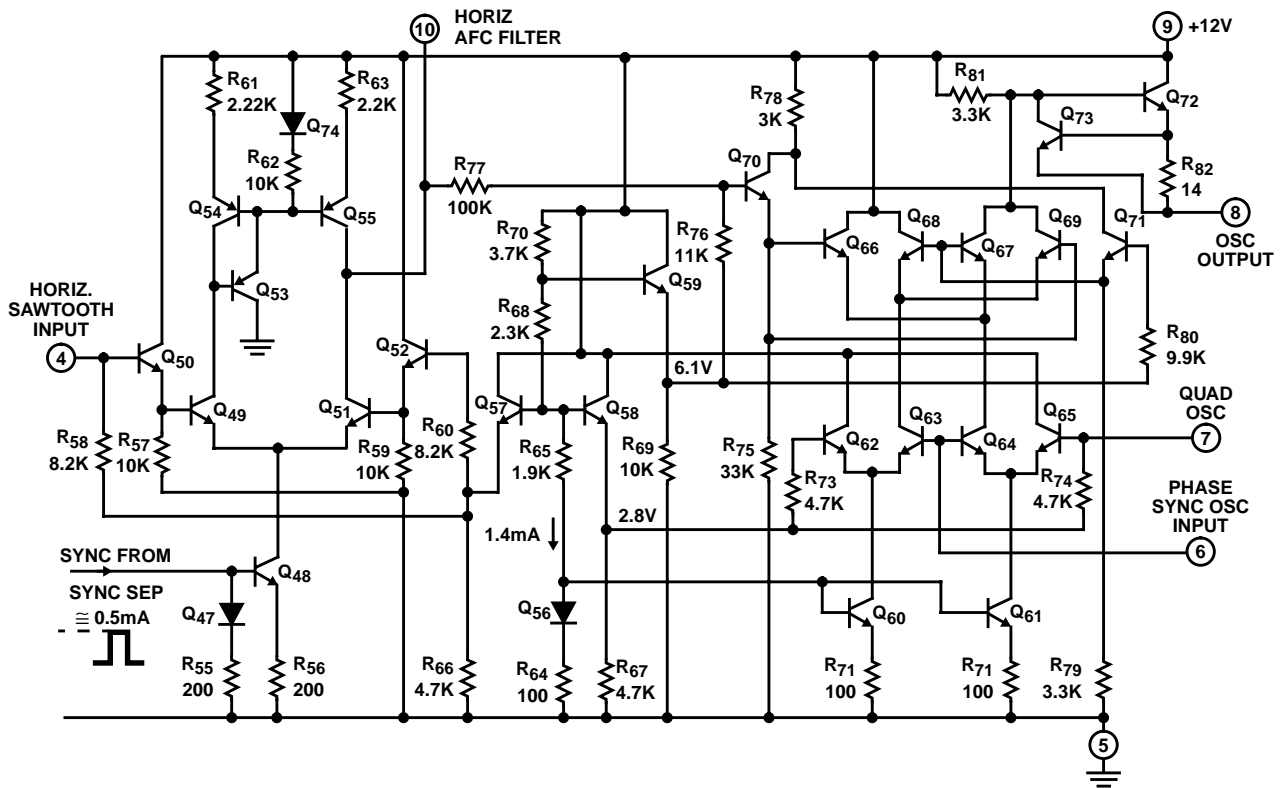

FIGURE 6. SCHEMATIC OF AFC-OSCILLATOR SECTION OF THE CA3154

CA3154

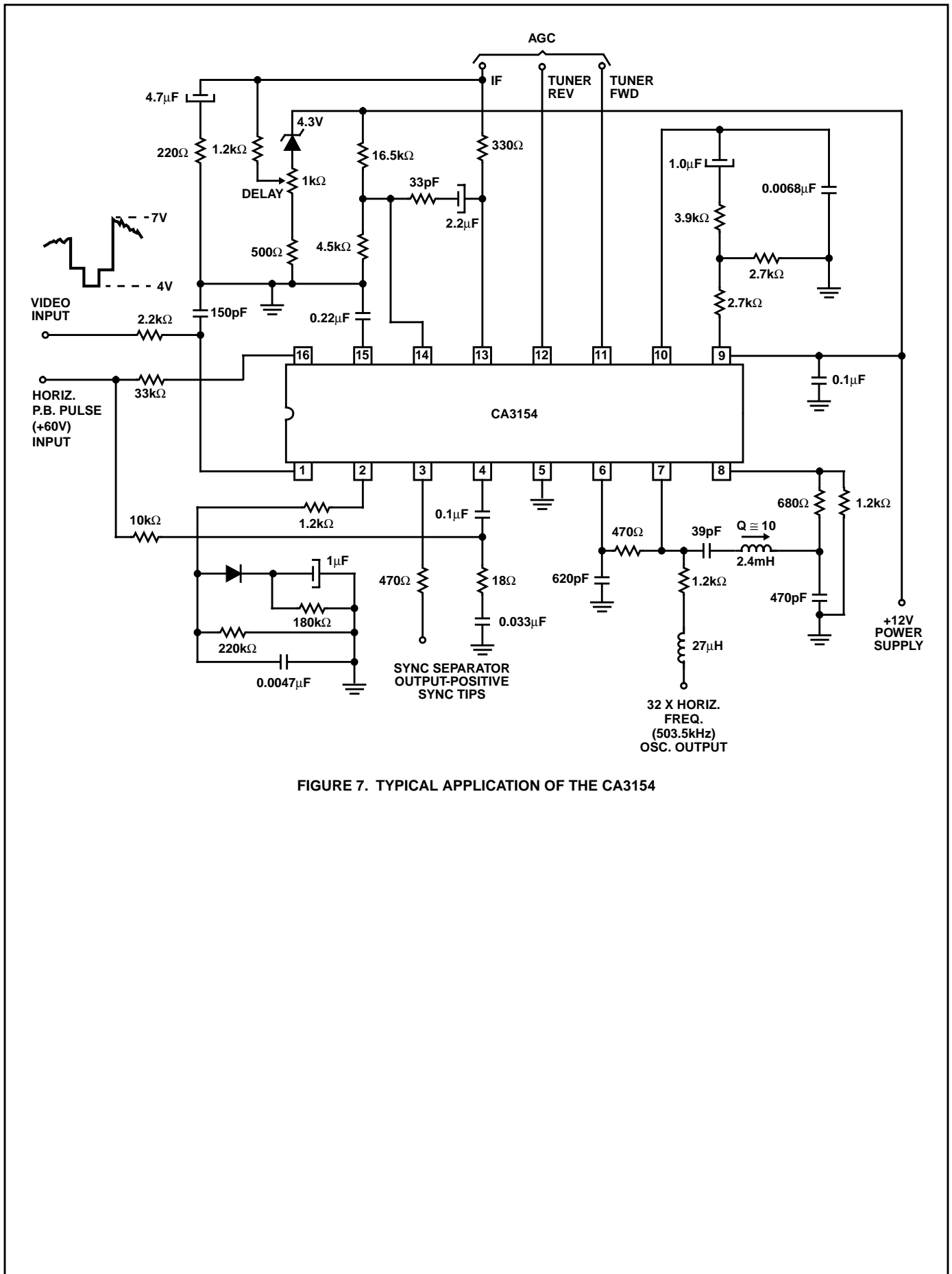

FIGURE 7. TYPICAL APPLICATION OF THE CA3154