

# SPECIFICATION

Device Name : IGBT module

Type Name : IMBL400NB-060

Spec. No. : **MS5F3233**

This material and the information herein is the property of Fuji Electric Co., Ltd. They shall be neither reproduced, copied, lent, or disclosed in any way whatsoever for the use of any third party nor used for the manufacturing purposes without the express written consent of Fuji Electric Co., Ltd.

Fuji Electric Co., Ltd.  
Matsumoto Factory

	DATE	NAME	APPROVED	Fuji Electric Co., Ltd.	
DRAWN	Oct. - 3 - 95	S. Miyashita	S. Kobayashi	DWG. NO.	<b>MS5F3233</b> 1/8
CHECKED	Oct. - 3 - 95	T. HOSEN			



Ratings and characteristics of Fuji IGBT Module

1MBI400NB-060

1. Outline Drawing

Unit : mm

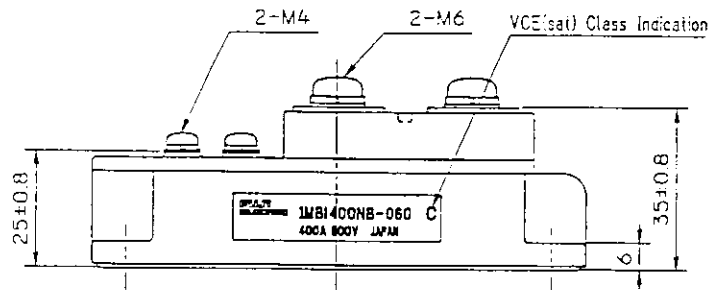
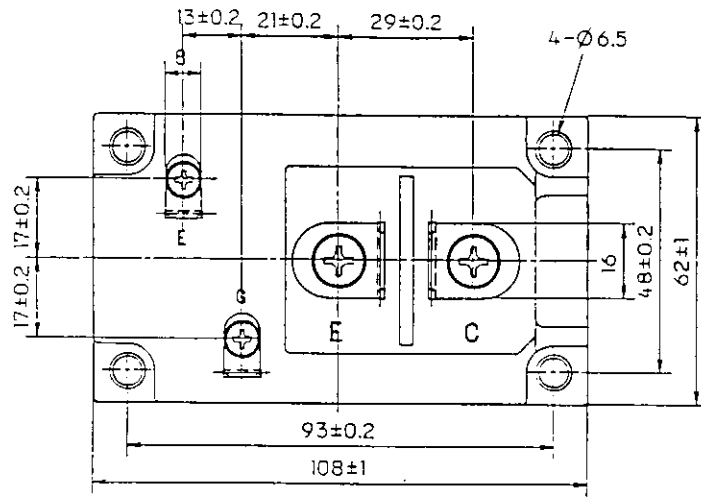

2. Equivalent circuit

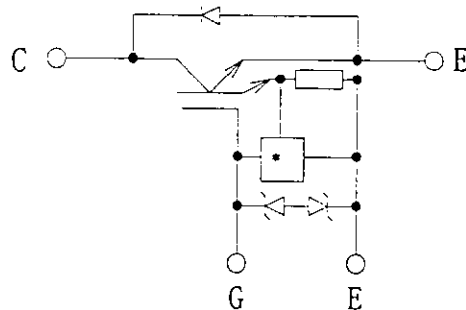

\*NLU (Over Current Limiting Circuit)

Fuji Electric Co. Ltd. They shall be neither reproduced, copied, lent, or disclosed in any way whatsoever for the use of any third party nor used for the manufacturing purposes without the express written consent of Fuji Electric Co., Ltd.

3. Absolute Maximum Ratings ( at Tc=25°C unless otherwise specified )

Items		Symbols	Ratings	Units
Collector-Emitter voltage		V <sub>CES</sub>	600	V
Gate-Emitter voltage		V <sub>GES</sub>	±20	V
Collector current	Continuous	I <sub>c</sub>	400	A
	1ms	I <sub>c</sub> pulse	800	
		-I <sub>c</sub>	400	
	1ms	-I <sub>c</sub> pulse	800	
Max. power dissipation		P <sub>C</sub>	1500	W
Operating temperature		T <sub>j</sub>	+150	°C
Storage temperature		T <sub>stg</sub>	-40~+125	°C
Isolation voltage		V <sub>is</sub>	AC 2500 (1min.)	V
Screw torque	Mounting *1		3.5	N · m
	Terminals *2		4.5	
	Terminals *3		1.7	

Note : \*1 Recommendable value : 2.5~3.5 N · m (M5) or (M6)

\*2 Recommendable value : 3.5~4.5 N · m (M6)

\*3 Recommendable value : 1.3~1.7 N · m (M4)

4. Electrical characteristics ( at T<sub>j</sub>=25°C unless otherwise specified)

Items	Symbols	Characteristics			Conditions	Units
		min.	typ.	max.		
Zero gate voltage Collector current	I <sub>CES</sub>			4.0	V <sub>GE</sub> =0V, V <sub>CES</sub> =600V	mA
Gate-Emitter leakage current	I <sub>GES</sub>			60	V <sub>CE</sub> =0V, V <sub>GE</sub> =±20V	μA
Gate-Emitter threshold voltage	V <sub>GE(th)</sub>	4.5		7.5	V <sub>CE</sub> =20V, I <sub>c</sub> =400mA	V
Collector-Emitter saturation voltage	V <sub>CE(sat)</sub>			2.8	V <sub>GE</sub> =15V, I <sub>c</sub> =400A	V
Input capacitance	C <sub>ies</sub>		26400		V <sub>GE</sub> =0V	pF
Output capacitance	C <sub>oes</sub>		5870		V <sub>CE</sub> =10V	
Reverse transfer capacitance	C <sub>res</sub>		2670		f=1MHz	
Turn-on time	t <sub>on</sub>		0.6	1.2	V <sub>cc</sub> =300V	μs
	t <sub>r</sub>		0.2	0.6	I <sub>c</sub> =400A	
Turn-off time	t <sub>off</sub>		0.6	1.0	V <sub>GE</sub> =±15V	
	t <sub>f</sub>		0.2	0.35	R <sub>G</sub> =4.7Ω	
Diode forward on voltage	V <sub>F</sub>			3.0	I <sub>F</sub> =400A, V <sub>GE</sub> =0V	V
Reverse recovery time	t <sub>rr</sub>			300	I <sub>F</sub> =400A	ns

5. Thermal resistance characteristics

Items	Symbols	Characteristics			Conditions	Units
		min.	typ.	max.		
Thermal resistance	R <sub>th(j-c)</sub>			0.085	IGBT	°C/W
	R <sub>th(j-c)</sub>			0.18	Diode	
	※		0.0125		the base to cooling	
	R <sub>th(c-f)</sub>				fin	

※ This is the value which is defined mounting on the additional cooling fin with thermal compound.

6. VCE(sat) class

Class	VCE(sat) range [V]
F	1.85 ~ 2.1
A	2.0 ~ 2.25
B	2.15 ~ 2.4
C	2.3 ~ 2.6
D	2.5 ~ 2.8

7. Indication on module (モジュール表示)

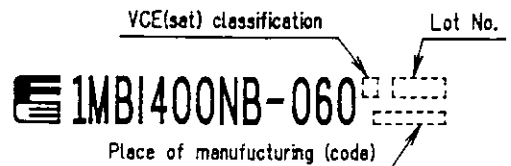
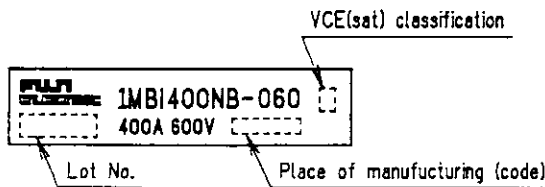

8. Applicable category (適用範囲)

This specification is applied to IGBT module named 1MBI400NB-060.  
 本納入仕様書は、IGBTモジュール 1MBI400NB-060 に適用する。

9. Storage and transportation notes (保管、運搬上の注意事項)

- The IGBT module should be stored at a standard temperature of 5 to 35°C and humidity of 45 to 75%.  
 常温保存が望ましい。(5~35°C、45~75%)
- Store modules in a place with few temperature changes in order to avoid condensation on the module surface.  
 急激な温度変化の無きこと。(モジュール表面が結露しないこと)
- Avoid exposure to corrosive gases and dust.  
 腐蝕性ガスの発生場所、塵埃の多い場所は避けること。
- Avoid excessive external force on the module.  
 製品に荷重がかからないように十分注意すること。
- Store modules with unprocessed terminals.  
 モジュールの端子は未加工の状態での保管すること。
- Do not drop or otherwise shock the modules when transporting.  
 製品の運搬時に衝撃を与えたり、落下させたりしないこと。

Collector current vs. Collector-Emitter voltage  
T<sub>j</sub>=25°C

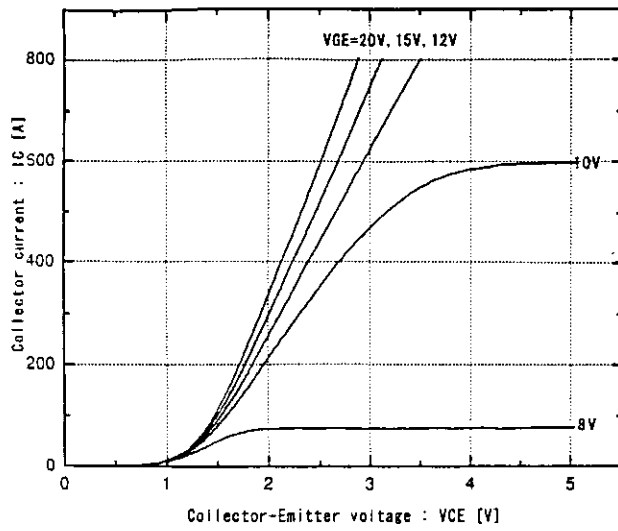

Collector current vs. Collector-Emitter voltage  
T<sub>j</sub>=125°C

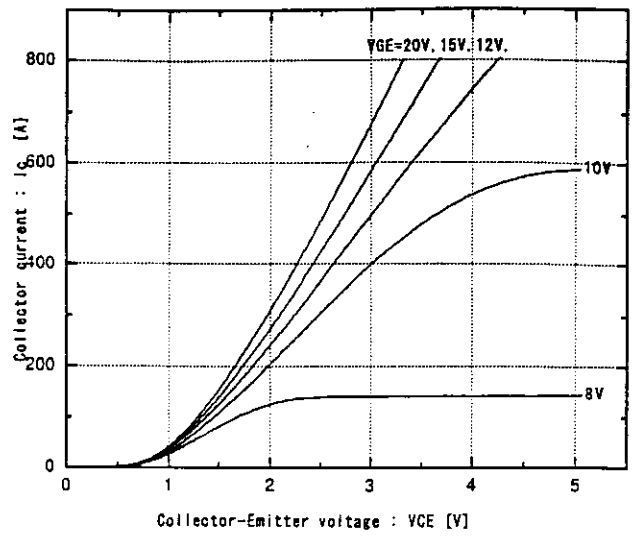

Collector-Emitter vs. Gate-Emitter voltage  
T<sub>j</sub>=25°C

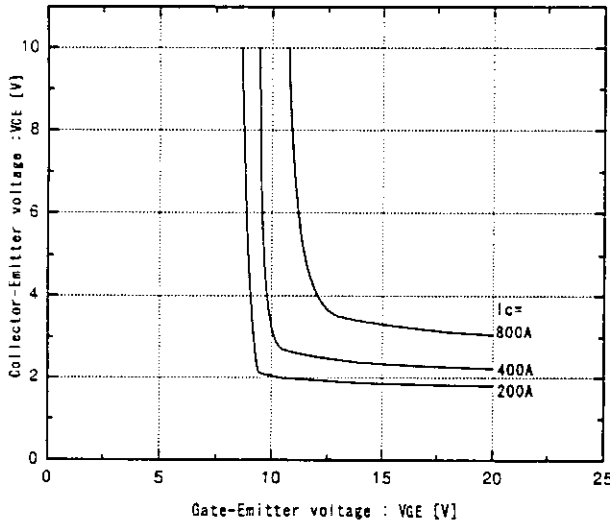

Collector-Emitter vs. Gate-Emitter voltage  
T<sub>j</sub>=125°C

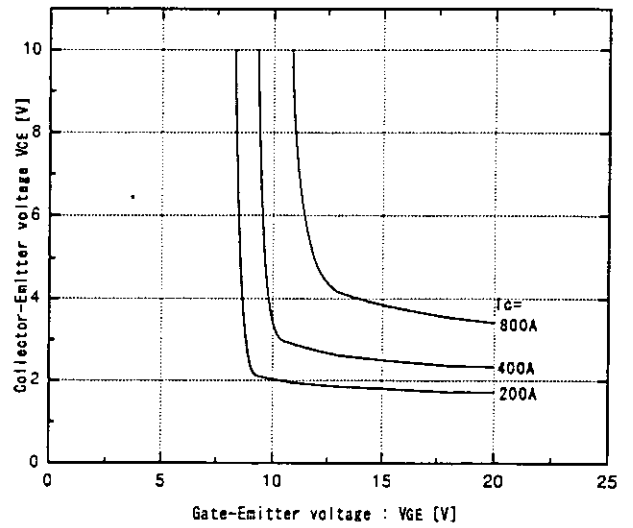

Switching time vs. Collector current  
V<sub>cc</sub>=300V, R<sub>G</sub>=4.7Ω, V<sub>GE</sub>±15V, T<sub>j</sub>=25°C

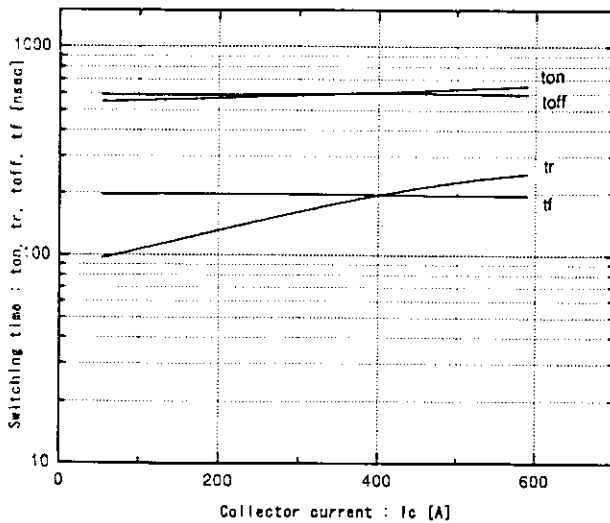

Switching time vs. Collector current  
V<sub>cc</sub>=300V, R<sub>G</sub>=4.7Ω, V<sub>GE</sub>±15V, T<sub>j</sub>=125°C

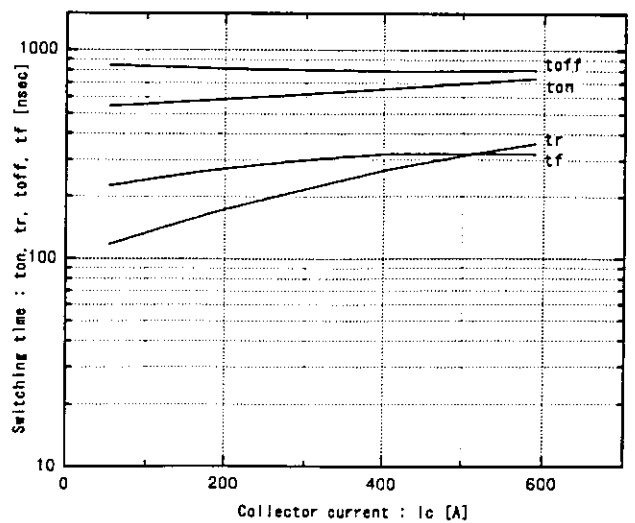

Fuji Electric Co., Ltd.

DWG. NO.

MS5F3238

E/S

H04-004-03

This material and the information herein is the property of Fuji Electric Co. Ltd. They shall be neither reproduced, copied, lent, or disclosed in any way whatsoever for the use of any third party nor used for the manufacturing purposes without the express written consent of Fuji Electric Co., Ltd.

This material and the information herein is the property of Fuji Electric Co. Ltd. They shall be neither reproduced, copied, lent, or disclosed in any way whatsoever for the use of any third party nor used for the manufacturing purposes without the express written consent of Fuji Electric Co., Ltd.

Switching time vs.  $R_G$   
 $V_{CC}=300V, I_C=400A, V_{GE}=\pm 15V, T_J=25^\circ C$

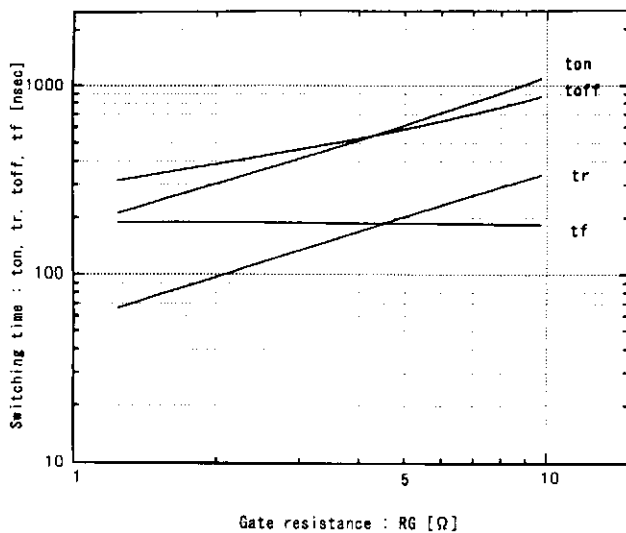

Dynamic input characteristics  
 $T_J=25^\circ C$

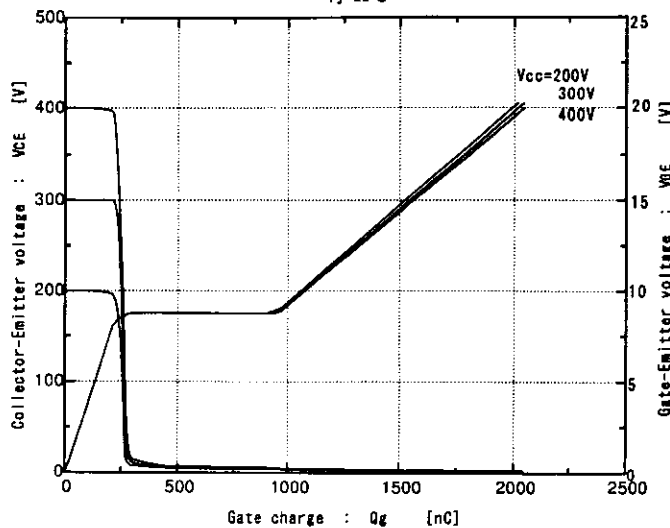

Forward current vs. Forward voltage  
 $V_{GE}=0V$

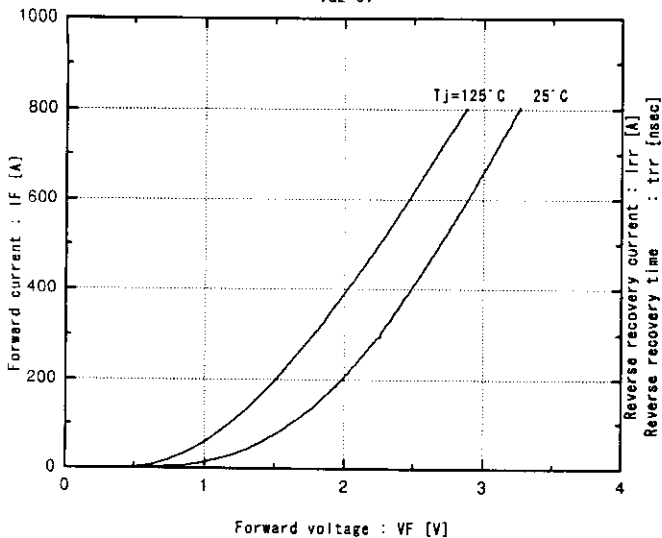

Reverse recovery characteristics  
 $t_{rr}, I_{rr}$  vs.  $I_F$

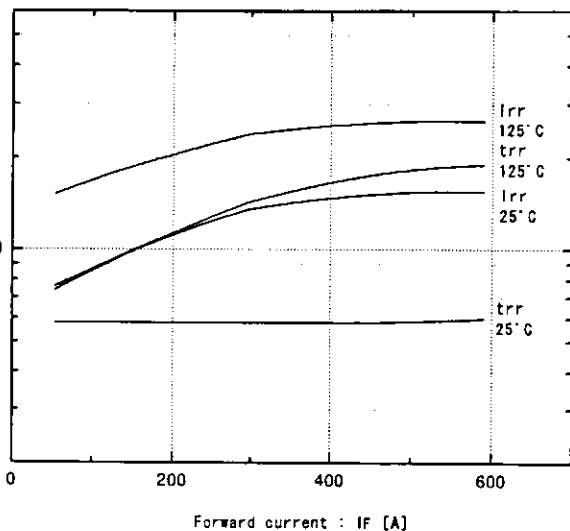

Transient thermal resistance

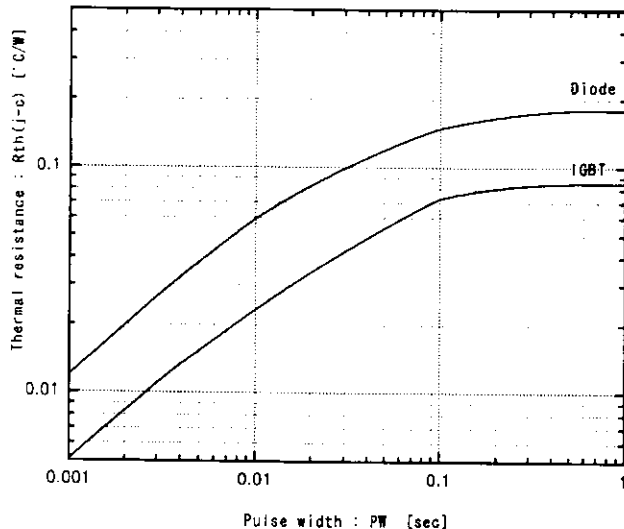

Reversed biased safe operating area  
 $+V_{GE}=15V, -V_{GE}\leq 15V, T_J\leq 125^\circ C, R_G\geq 4.7\Omega$

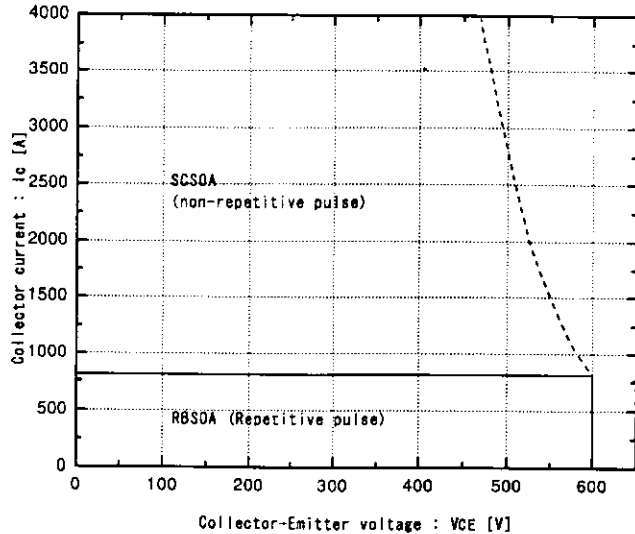

Fuji Electric Co., Ltd.

DWG. NO.

MS5F3238

Switching loss vs. Collector current  
 $V_{CC}=300V$ ,  $R_G=4.7\Omega$ ,  $V_{GE}=\pm 15V$

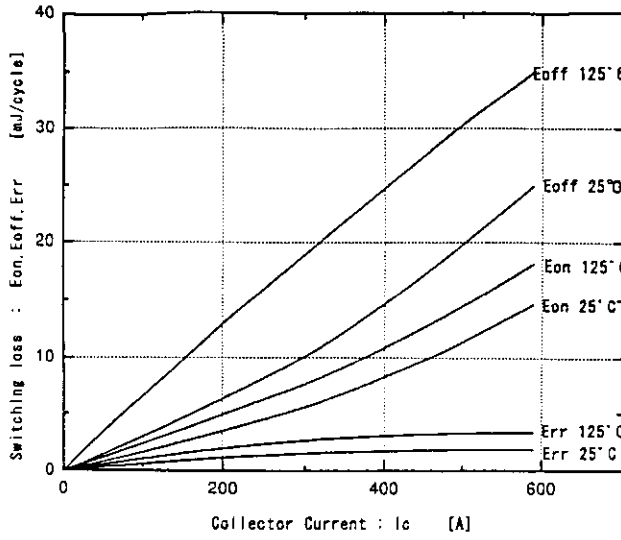

Capacitance vs. Collector-Emitter voltage  
 $T_J=25^\circ C$

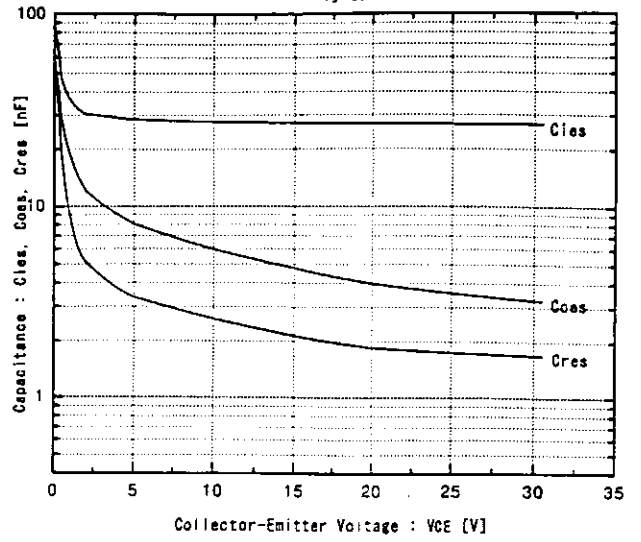

This material and the information herein is the property of Fuji Electric Co. Ltd. They shall be neither reproduced, copied, lent, or disclosed in any way whatsoever for the use of any third party nor used for the manufacturing purposes without the express written consent of Fuji Electric Co., Ltd.

Fuji Electric Co., Ltd.

DWG NO.

MS5F3238

8/8

H04-004-03