

# BIPOLAR ANALOG INTEGRATED CIRCUIT

# $\mu$ PC3210TB

## 5 V, SUPER MINIMOLD SILICON MMIC WIDEBAND AMPLIFIER

### DESCRIPTION

The  $\mu$ PC3210TB is a silicon monolithic integrated circuits designed as wideband amplifier. The  $\mu$ PC3210TB is suitable to systems required wideband operation from HF to L band.

This IC is manufactured using NEC's 20 GHz fr NESAT™III silicon bipolar process. This process uses silicon nitride passivation film and gold electrodes. These materials can protect chip surface from external pollution and prevent corrosion/migration. Thus, this IC has excellent performance, uniformity and reliability.

### FEATURES

- High-density surface mounting: 6-pin super minimold package
- Supply voltage :  $V_{CC} = 4.5$  to  $5.5$  V
- Wideband response :  $f_u = 2.3$  GHz TYP. @3 dB bandwidth
- Power gain :  $G_P = 20$  dB TYP. @ $f = 1.5$  GHz
- Noise figure :  $NF = 3.4$  dB TYP. @ $f = 1.5$  GHz

### APPLICATION

- Systems required wideband operation from HF to 2.0 GHz

### ORDERING INFORMATION

Part Number	Package	Marking	Supplying Form
$\mu$ PC3210TB-E3	6-pin super minimold	C2X	Embossed tape 8 mm wide. 1, 2, 3 pins face to perforation side of the tape. Qty 3 kp/reel.

**Remark** To order evaluation samples, please contact your local NEC sales office. (Part number for sample order:  $\mu$ PC3210TB)

### Caution Electro-static sensitive devices

The information in this document is subject to change without notice. Before using this document, please confirm that this is the latest version.  
Not all devices/types available in every country. Please check with local NEC representative for availability and additional information.

**PIN CONNECTIONS**

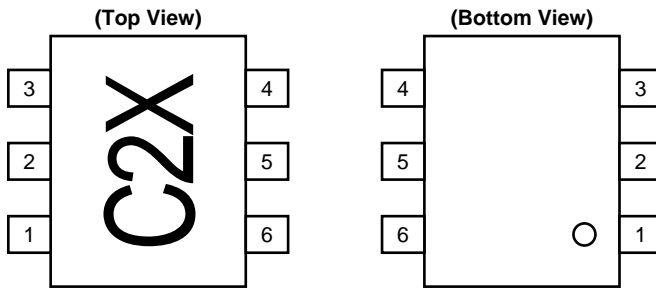

Pin No.	Pin Name
1	INPUT
2	GND
3	GND
4	OUTPUT
5	GND
6	V <sub>CC</sub>

**★ PRODUCT LINE-UP OF 5V-BIAS SILICON MMIC WIDEBAND AMPLIFIERS**

(T<sub>A</sub> = +25 °C, V<sub>CC</sub> = 5.0 V, Z<sub>L</sub> = Z<sub>S</sub> = 50 Ω)

Part No.	f <sub>u</sub> (GHz)	P <sub>O (sat)</sub> (dBm)	G <sub>P</sub> (dB)	NF (dB)	I <sub>CC</sub> (mA)	Package	Marking
$\mu$ PC2711T	2.9	+1.0	13	5.0 @f = 1 GHz	12	6-pin minimold	C1G
$\mu$ PC2711TB						6-pin super minimold	
$\mu$ PC2712T	2.6	+3.0	20	4.5 @f = 1 GHz	12	6-pin minimold	C1H
$\mu$ PC2712TB						6-pin super minimold	
$\mu$ PC2713T	1.2	+7.0	29	3.2 @f = 0.5 GHz	12	6-pin minimold	C1J
$\mu$ PC2791TB	1.9	+4.0	12	5.5 @f = 0.5 GHz	17	6-pin super minimold	C2S
$\mu$ PC2792TB	1.2	+5.0	20	3.5 @f = 0.5 GHz	19	6-pin super minimold	C2T
$\mu$ PC3210TB	2.3	+3.5	20	3.4 @f = 1.5 GHz	15	6-pin super minimold	C2X

**Remark** Typical performance. Please refer to ELECTRICAL CHARACTERISTICS in detail.

**Notice** The package size distinguishes between minimold and super minimold.

**PIN EXPLANATION**

Pin No.	Pin Name	Applied Voltage V	Pin Voltage V <sup>Note</sup>	Function and Applications	Internal Equivalent Circuit
1	INPUT	—	0.82	Signal input pin. A internal matching circuit, configured with resistors, enables 50 Ω connection over a wide band. A multi-feedback circuit is designed to cancel the deviations of h <sub>FE</sub> and resistance. This pin must be coupled to signal source with capacitor for DC cut.	
4	OUTPUT	—	4.0	Signal output pin. A internal matching circuit, configured with resistors, enables 50 Ω connection over a wide band. This pin must be coupled to next stage with capacitor for DC cut.	
6	V <sub>CC</sub>	4.5 to 5.5	—	Power supply pin. This pin should be externally equipped with bypass capacitor to minimize ground impedance.	
2 3 5	GND	0	—	Ground pin. This pin should be connected to system ground with minimum inductance. Ground pattern on the board should be formed as wide as possible. All the ground pins must be connected together with wide ground pattern to decrease impedance difference.	

**Note** Pin voltage is measured at V<sub>CC</sub> = 5.0 V

**ABSOLUTE MAXIMUM RATINGS**

Parameter	Symbol	Conditions	Ratings	Unit
Supply Voltage	V <sub>CC</sub>	T <sub>A</sub> = +25 °C	6.0	V
Circuit Current	I <sub>CC</sub>	T <sub>A</sub> = +25 °C	30	mA
Total Power Dissipation	P <sub>D</sub>	Mounted on double sided copper clad 50 × 50 × 1.6 mm epoxy glass PWB (T <sub>A</sub> = +85 °C)	200	mW
Operating Ambient Temperature	T <sub>A</sub>		−40 to +85	°C
Storage Temperature	T <sub>stg</sub>		−55 to +150	°C
Input Power Level	P <sub>in</sub>	T <sub>A</sub> = +25 °C	+10	dBm

**RECOMMENDED OPERATING CONDITIONS**

Parameter	Symbol	MIN.	TYP.	MAX.	Unit
Supply Voltage	V <sub>CC</sub>	4.5	5.0	5.5	V
Operating Ambient Temperature	T <sub>A</sub>	−40	+25	+85	°C

**ELECTRICAL OPERATING CONDITIONS (T<sub>A</sub> = +25°C, V<sub>CC</sub> = 5.0 V, Z<sub>S</sub> = Z<sub>L</sub> = 50 Ω)**

Parameter	Symbol	Test Conditions	MIN.	TYP.	MAX.	Unit
Circuit Current	I <sub>CC</sub>	No signals	11.5	15.0	19.5	mA
Power Gain	G <sub>P</sub>	f = 1.5 GHz	18	20	−	dB
Noise Figure	NF	f = 1.5 GHz	−	3.4	4.4	dB
Upper Limit Operating Frequency	f <sub>u</sub>	3 dB down below from gain at f = 0.1 GHz	2.05	2.3	−	GHz
Isolation	ISL	f = 1.5 GHz	29	34	−	dB
Input Return Loss	RL <sub>in</sub>	f = 1.5 GHz	10	14.5	−	dB
Output Return Loss	RL <sub>out</sub>	f = 1.5 GHz	7	11	−	dB
Maximum Output Level	P <sub>O(sat)</sub>	f = 1.5 GHz, P <sub>in</sub> = 0 dBm	+0.5	+3.5	−	dBm
Gain Flatness	ΔG <sub>P</sub>	f = 0.1 GHz to 2.05 GHz	−	±1.0	−	dB

TEST CIRCUIT

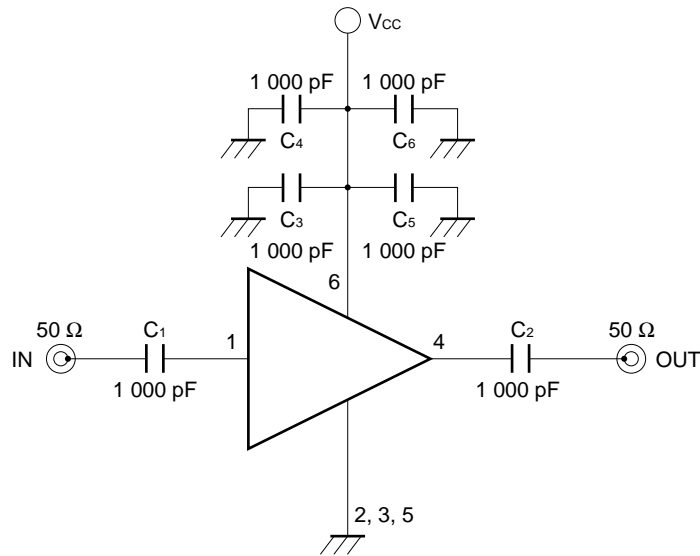

EXAMPLE OF APPLICATION CIRCUIT

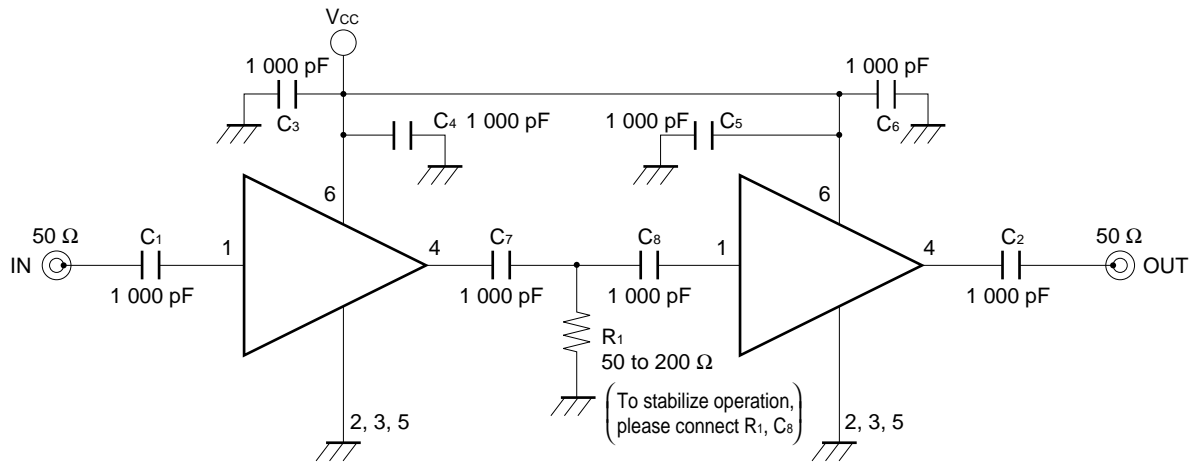

The application circuits and their parameters are for reference only and are not intended for use in actual design-ins.

Capacitors for Vcc, input and output pins

1 000 pF capacitors are recommendable as bypass capacitor for Vcc pin and coupling capacitors for input/output pins.

Bypass capacitor for Vcc pin is intended to minimize Vcc pin's ground impedance. Therefore, stable bias can be supplied against Vcc fluctuation.

Coupling capacitors for input/output pins are intended to minimize RF serial impedance and cut DC.

To get flat gain from 100 MHz up, 1 000 pF capacitors are assembled on the test circuit. [Actually, 1 000 pF capacitors give flat gain at least 10 MHz. In the case of under 10 MHz operation, increase the value of coupling capacitor such as 2 200 pF. Because the coupling capacitors are determined by the equation of  $C = 1/(2 \pi fZ_s)$ .]

ILLUSTRATION OF THE TEST CIRCUIT ASSEMBLED ON EVALUATION BOARD

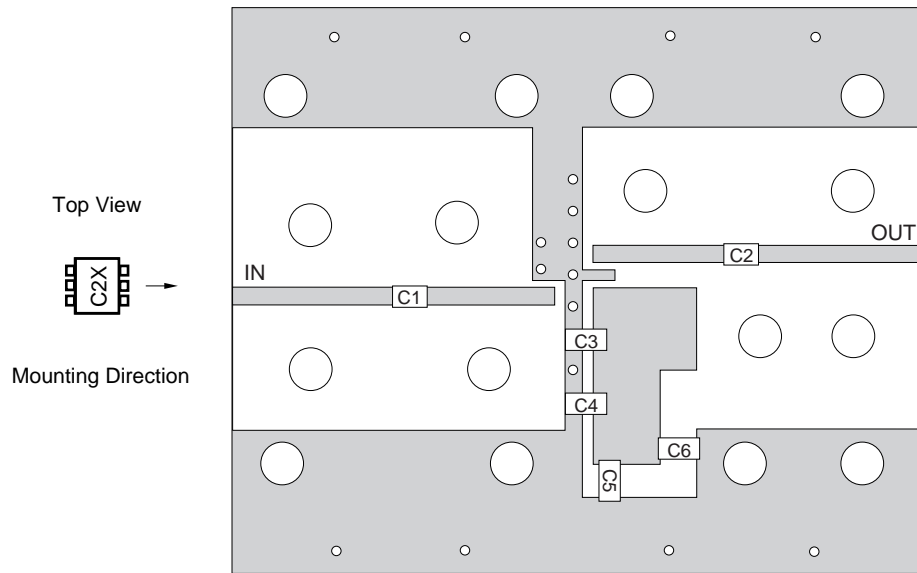

COMPONENT LIST

	Value
C1 to C6	1 000 pF

Notes

1. 42 × 35 × 0.4 mm double sided copper clad polyimide board.
2. Back side: GND pattern
3. Solder plated on pattern
4. ○: Through holes

★ TYPICAL CHARACTERISTICS (Unless otherwise specified,  $T_A = +25\text{ }^\circ\text{C}$ )

CIRCUIT CURRENT vs. SUPPLY VOLTAGE

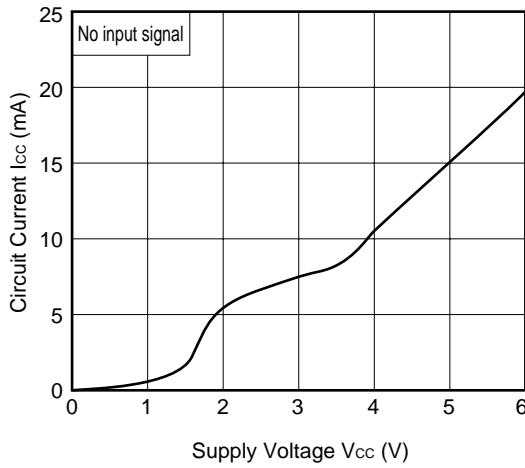

CIRCUIT CURRENT vs. OPERATING AMBIENT TEMPERATURE

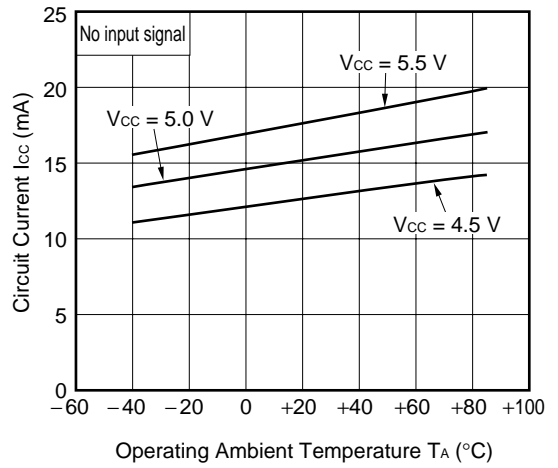

NOISE FIGURE AND INSERTION POWER GAIN vs. FREQUENCY

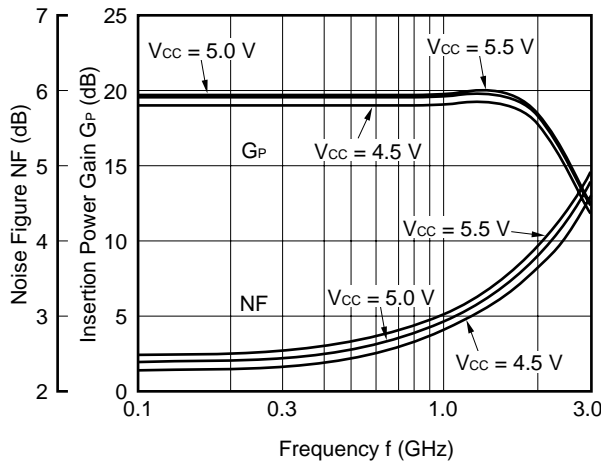

NOISE FIGURE AND INSERTION POWER GAIN vs. FREQUENCY

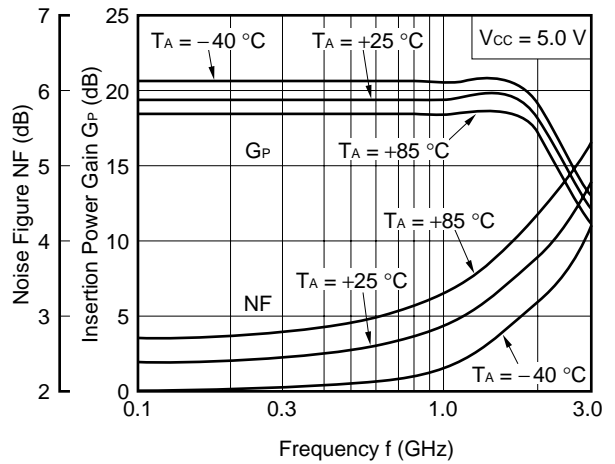

ISOLATION vs. FREQUENCY

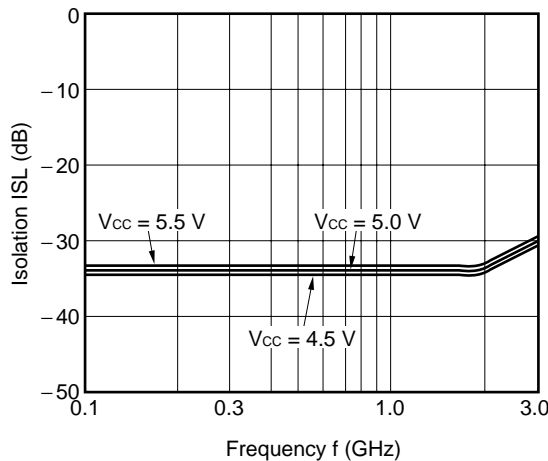

ISOLATION vs. FREQUENCY

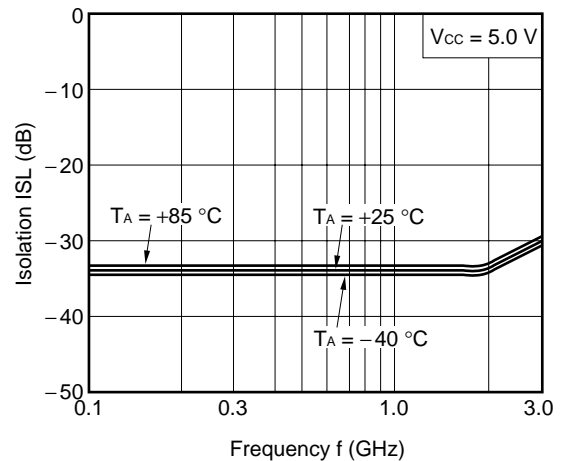

INPUT RETURN LOSS vs. FREQUENCY

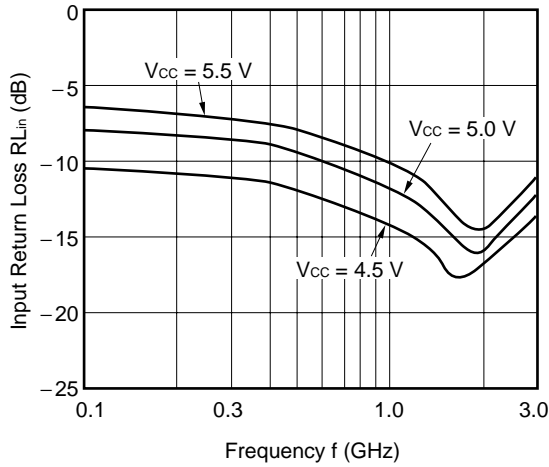

INPUT RETURN LOSS vs. FREQUENCY

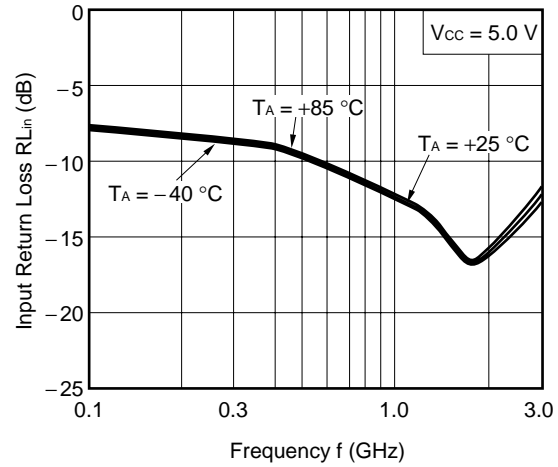

OUTPUT RETURN LOSS vs. FREQUENCY

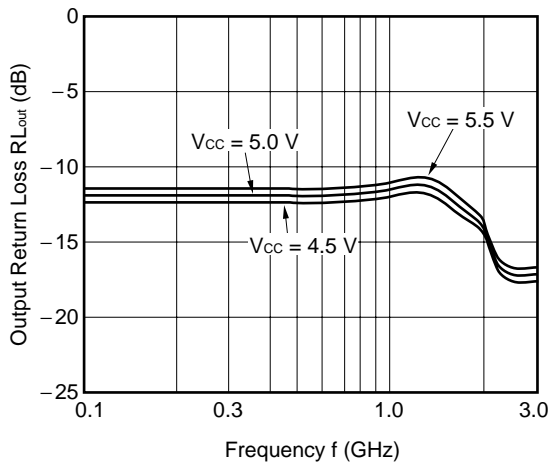

OUTPUT RETURN LOSS vs. FREQUENCY

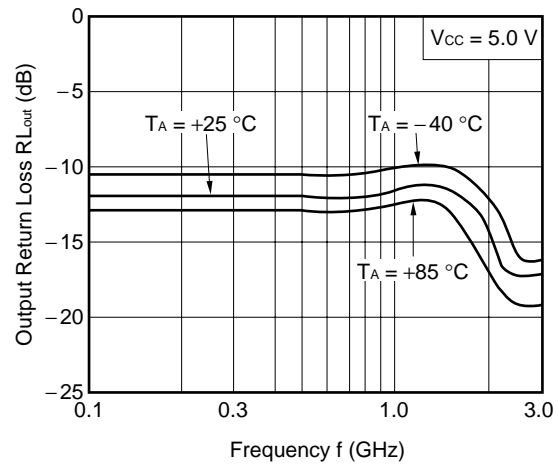

OUTPUT POWER vs. INPUT POWER

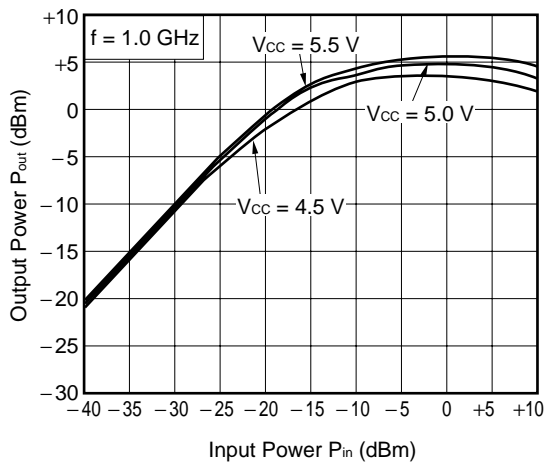

OUTPUT POWER vs. INPUT POWER

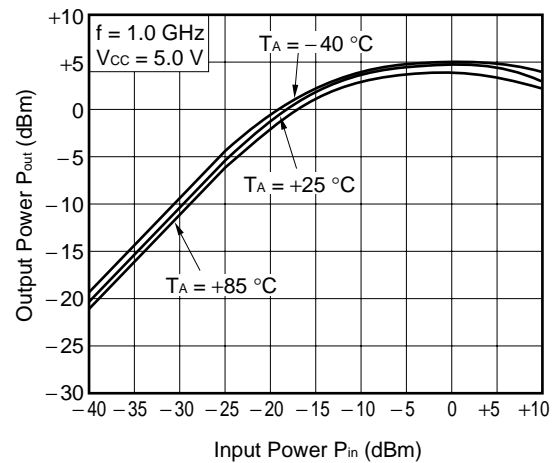



OUTPUT POWER vs. INPUT POWER

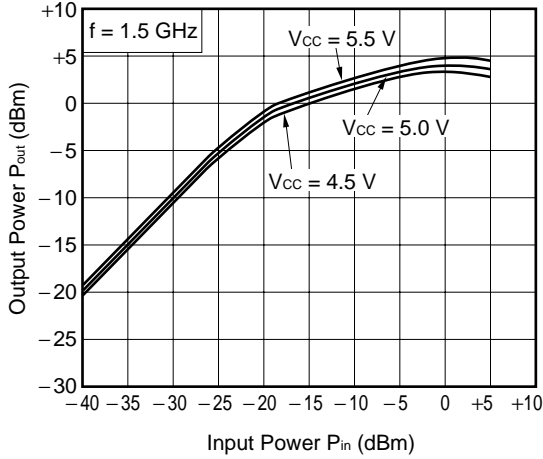

OUTPUT POWER vs. INPUT POWER

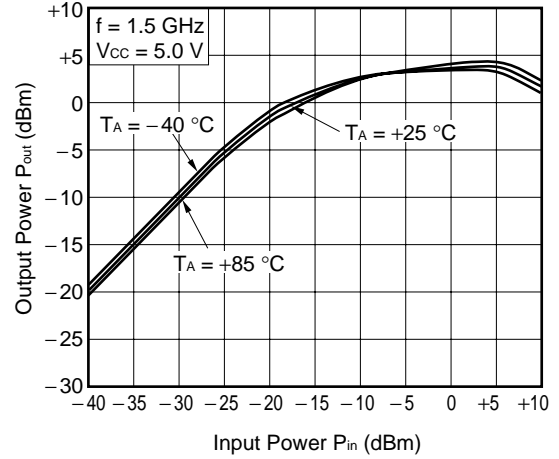

OUTPUT POWER vs. INPUT POWER

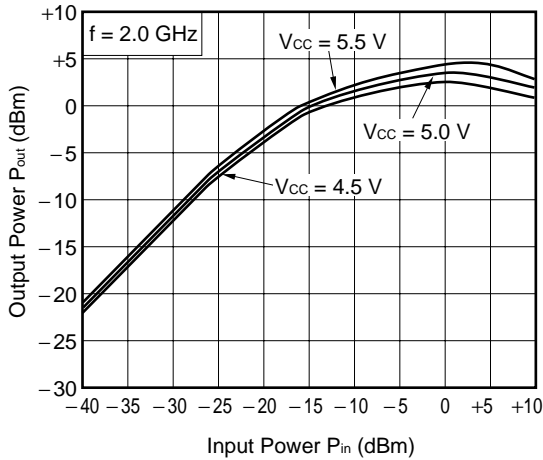

OUTPUT POWER vs. INPUT POWER

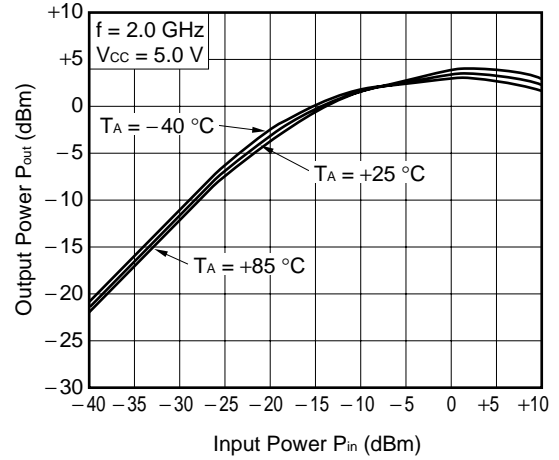

SATURATED OUTPUT POWER vs. FREQUENCY

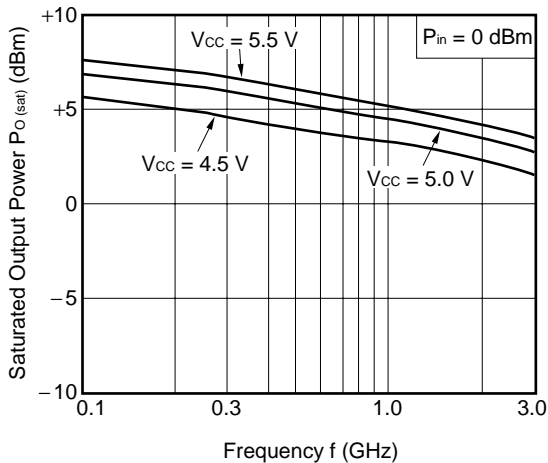

SATURATED OUTPUT POWER vs. FREQUENCY

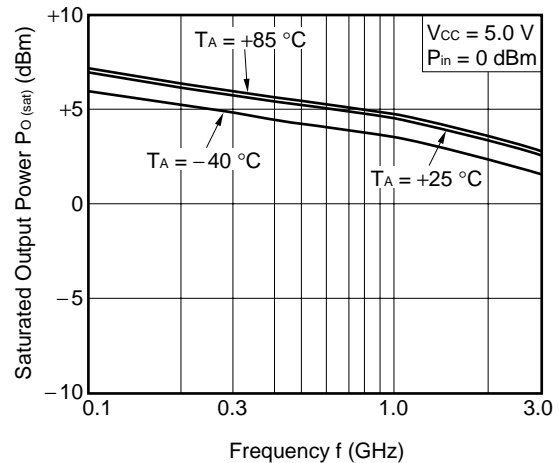

THIRD ORDER INTERMODULATION DISTORTION AND OUTPUT POWER OF EACH TONE vs. INPUT POWER OF EACH TONE

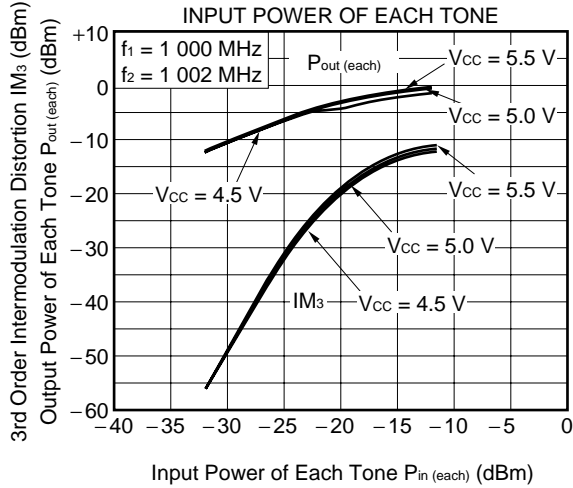

THIRD ORDER INTERMODULATION DISTORTION vs. OUTPUT POWER OF EACH TONE

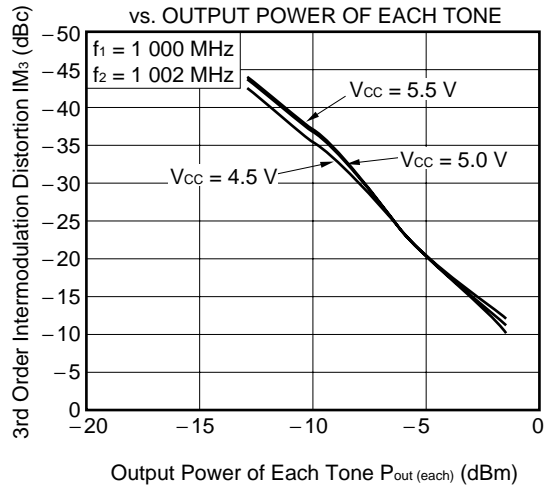

THIRD ORDER INTERMODULATION DISTORTION AND OUTPUT POWER OF EACH TONE vs. INPUT POWER OF EACH TONE

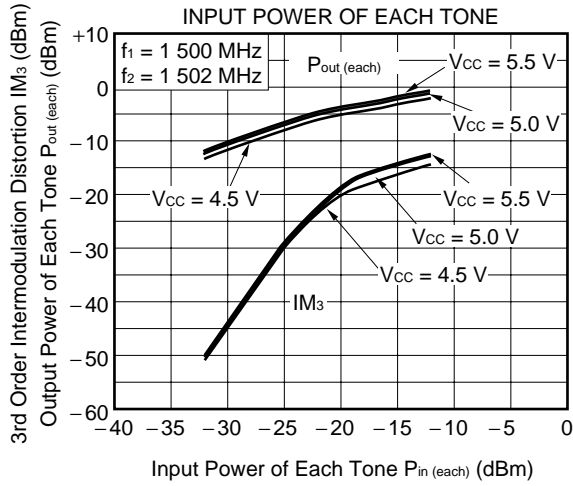

THIRD ORDER INTERMODULATION DISTORTION vs. OUTPUT POWER OF EACH TONE

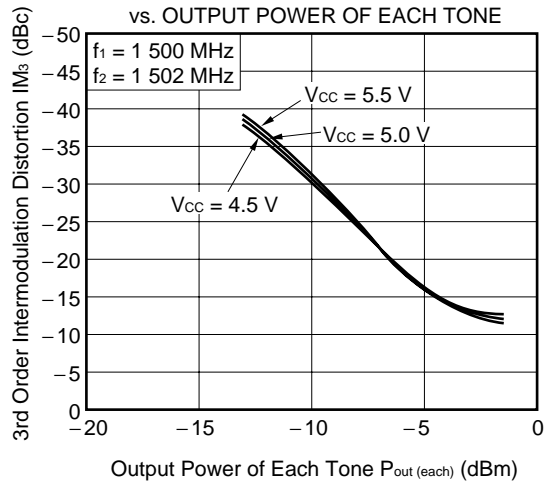

THIRD ORDER INTERMODULATION DISTORTION AND OUTPUT POWER OF EACH TONE vs. INPUT POWER OF EACH TONE

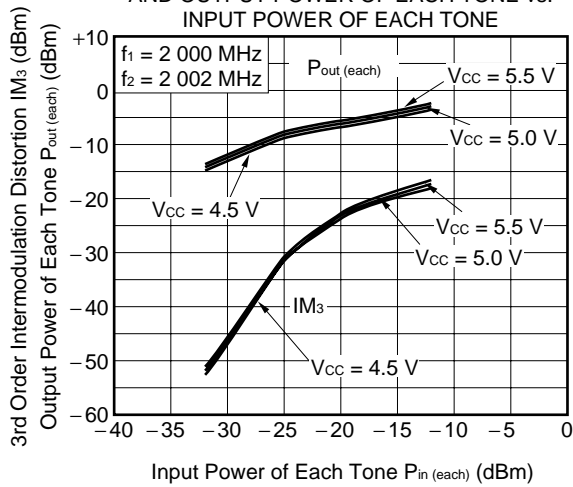

THIRD ORDER INTERMODULATION DISTORTION vs. OUTPUT POWER OF EACH TONE

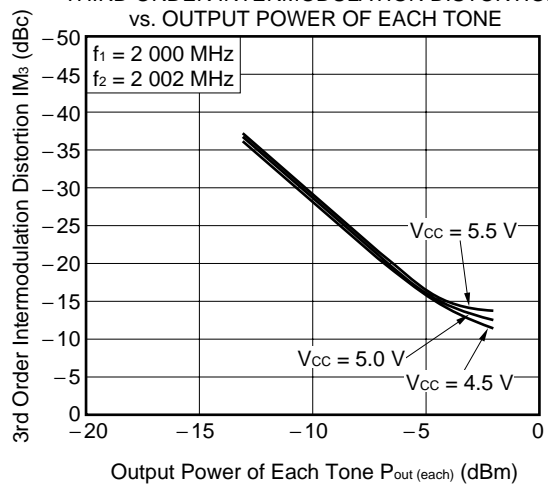

★ S-PARAMETER ( $V_{CC} = 5.0\text{ V}$ )

S<sub>11</sub>-FREQUENCY

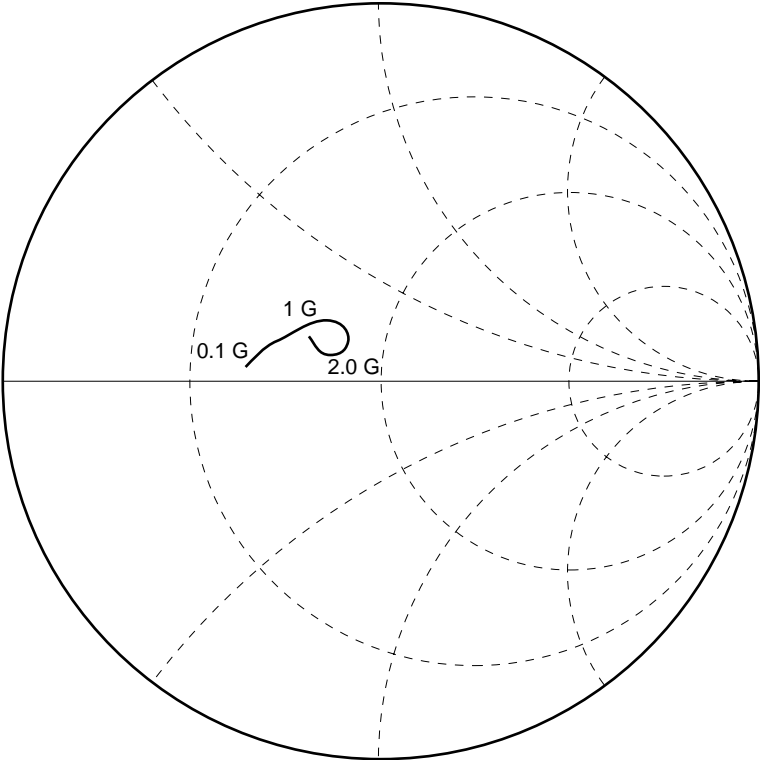

S<sub>22</sub>-FREQUENCY

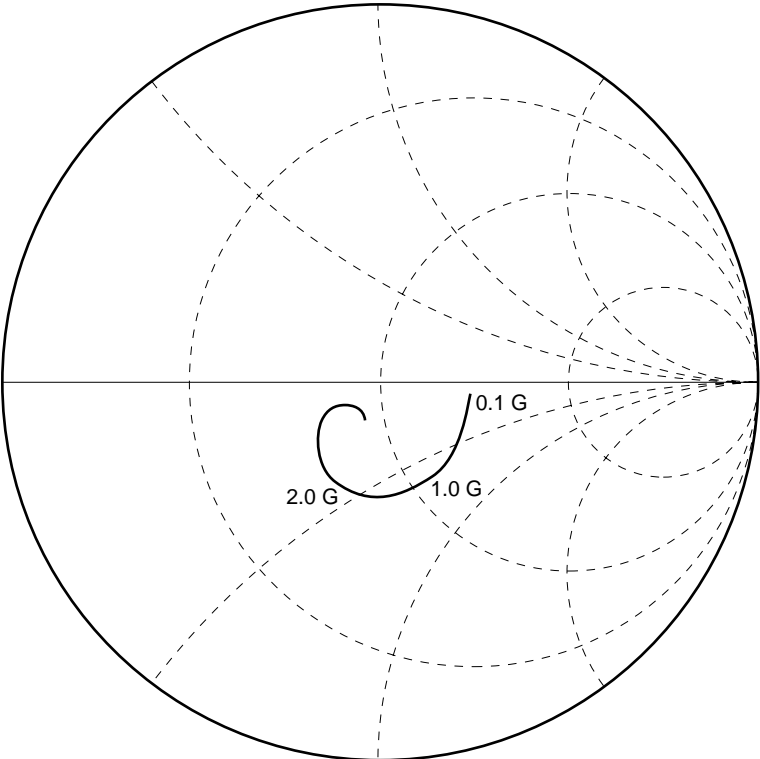

★ TYPICAL S-PARAMETER VALUES (T<sub>A</sub> = +25 °C)

μPC3210TB

V<sub>CC</sub> = 5.0 V, I<sub>CC</sub> = 16 mA

FREQUENCY MHz	S <sub>11</sub>		S <sub>21</sub>		S <sub>12</sub>		S <sub>22</sub>		K
	MAG.	ANG.	MAG.	ANG.	MAG.	ANG.	MAG.	ANG.	
100.0000	0.358	171.9	8.688	-4.4	0.019	-1.4	0.233	-6.8	2.63
200.0000	0.335	166.6	8.807	-10.6	0.019	3.3	0.237	-12.0	2.71
300.0000	0.321	160.7	8.821	-17.1	0.019	6.3	0.233	-15.1	2.68
400.0000	0.306	158.3	8.841	-23.3	0.019	9.9	0.233	-20.6	2.68
500.0000	0.294	154.4	8.908	-29.2	0.019	13.6	0.241	-25.6	2.67
600.0000	0.283	151.8	8.990	-35.1	0.019	15.8	0.246	-30.8	2.74
700.0000	0.273	148.6	9.160	-41.0	0.019	19.5	0.250	-35.8	2.67
800.0000	0.267	146.0	9.342	-47.3	0.018	24.3	0.256	-41.2	2.65
900.0000	0.260	144.2	9.541	-53.9	0.018	29.8	0.263	-47.9	2.69
1000.0000	0.252	141.5	9.741	-60.8	0.019	28.9	0.274	-53.1	2.46
1100.0000	0.246	138.4	10.071	-68.6	0.019	29.4	0.283	-59.0	2.37
1200.0000	0.239	135.9	10.393	-76.3	0.018	36.7	0.291	-65.7	2.38
1300.0000	0.229	133.3	10.513	-85.4	0.019	38.1	0.299	-71.9	2.25
1400.0000	0.224	131.1	10.763	-94.5	0.019	45.6	0.303	-79.7	2.20
1500.0000	0.215	127.4	10.708	-104.0	0.021	48.2	0.311	-87.6	2.05
1600.0000	0.203	125.8	10.720	-114.2	0.021	48.9	0.316	-94.9	2.07
1700.0000	0.191	123.1	10.388	-124.1	0.023	55.7	0.308	-103.4	1.98
1800.0000	0.179	122.1	9.993	-133.7	0.023	59.5	0.303	-111.5	2.02
1900.0000	0.163	121.0	9.507	-142.8	0.025	61.9	0.291	-119.5	2.01
2000.0000	0.155	123.4	8.983	-151.2	0.024	65.9	0.275	-128.4	2.17
2100.0000	0.140	126.1	8.384	-158.9	0.027	69.0	0.255	-135.0	2.14
2200.0000	0.133	129.1	7.905	-166.0	0.029	70.7	0.230	-140.5	2.12
2300.0000	0.130	135.3	7.412	-172.3	0.032	71.8	0.207	-145.9	2.10
2400.0000	0.133	139.0	6.976	-178.6	0.034	74.3	0.182	-150.3	2.12
2500.0000	0.137	144.0	6.582	176.1	0.038	73.2	0.157	-151.8	2.06
2600.0000	0.149	148.5	6.202	170.4	0.039	71.4	0.136	-152.1	2.13
2700.0000	0.157	150.2	5.942	164.9	0.043	73.7	0.116	-147.1	2.03
2800.0000	0.170	152.2	5.567	159.7	0.045	72.2	0.102	-137.8	2.04
2900.0000	0.181	150.3	5.360	153.9	0.047	72.5	0.099	-132.3	2.03
3000.0000	0.203	149.0	5.013	149.0	0.048	69.6	0.104	-122.3	2.10
3100.0000	0.209	147.9	4.810	142.9	0.051	71.0	0.117	-114.4	2.08

PACKAGE DIMENSIONS

6 pin super minimold (unit: mm)

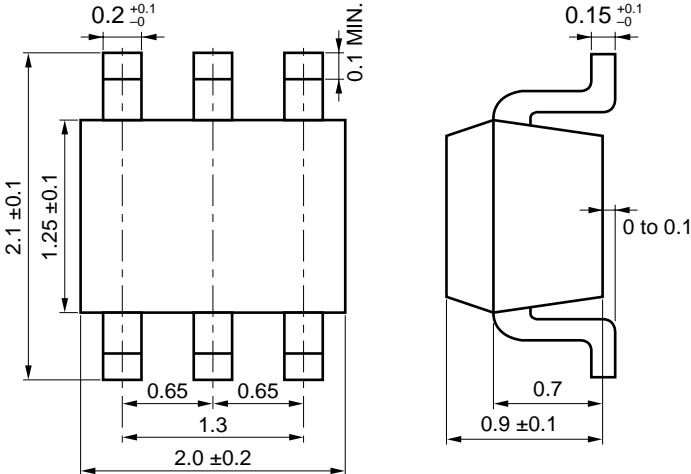

**NOTES ON CORRECT USE**

- (1) Observe precautions for handling because of electro-static sensitive devices.
- (2) Form a ground pattern as widely as possible to minimize ground impedance (to prevent undesired oscillation).  
All the ground pins must be connected together with wide ground pattern to decrease impedance difference.
- (3) The bypass capacitor should be attached to Vcc line.
- (4) The DC cut capacitor must be each attached to input and output pin.

**RECOMMENDED SOLDERING CONDITIONS**

This product should be soldered in the following recommended conditions. Other soldering methods and conditions than the recommended conditions are to be consulted with our sales representatives.

**μPC3210TB**

Soldering Method	Soldering Conditions	Recommended Condition Symbol
Infrared Reflow	Package peak temperature: 235 °C or below Time: 30 seconds or less (at 210 °C) Count: 3, Exposure limit <sup>Note</sup> : None	IR35-00-3
VPS	Package peak temperature: 215 °C or below Time: 40 seconds or less (at 200 °C) Count: 3, Exposure limit <sup>Note</sup> : None	VP15-00-3
Wave Soldering	Soldering bath temperature: 260 °C or below Time: 10 seconds or less Count: 1, Exposure limit <sup>Note</sup> : None	WS60-00-1
Partial Heating	Pin temperature: 300 °C Time: 3 seconds or less (per side of device) Exposure limit <sup>Note</sup> : None	-

**Note** After opening the dry pack, keep it in a place below 25 °C and 65 % RH for the allowable storage period.

**Caution** Do not use different soldering methods together (except for partial heating).

For details of recommended soldering conditions for surface mounting, refer to information document SEMICONDUCTOR DEVICE MOUNTING TECHNOLOGY MANUAL (C10535E).

[MEMO]

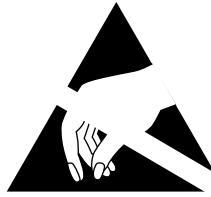

## ATTENTION

OBSERVE PRECAUTIONS  
FOR HANDLING  
ELECTROSTATIC  
SENSITIVE  
DEVICES

NESAT (NEC Silicon Advanced Technology) is a trademark of NEC Corporation.

- **The information in this document is subject to change without notice. Before using this document, please confirm that this is the latest version.**
  - No part of this document may be copied or reproduced in any form or by any means without the prior written consent of NEC Corporation. NEC Corporation assumes no responsibility for any errors which may appear in this document.
  - NEC Corporation does not assume any liability for infringement of patents, copyrights or other intellectual property rights of third parties by or arising from use of a device described herein or any other liability arising from use of such device. No license, either express, implied or otherwise, is granted under any patents, copyrights or other intellectual property rights of NEC Corporation or others.
  - Descriptions of circuits, software, and other related information in this document are provided for illustrative purposes in semiconductor product operation and application examples. The incorporation of these circuits, software, and information in the design of the customer's equipment shall be done under the full responsibility of the customer. NEC Corporation assumes no responsibility for any losses incurred by the customer or third parties arising from the use of these circuits, software, and information.
  - While NEC Corporation has been making continuous effort to enhance the reliability of its semiconductor devices, the possibility of defects cannot be eliminated entirely. To minimize risks of damage or injury to persons or property arising from a defect in an NEC semiconductor device, customers must incorporate sufficient safety measures in its design, such as redundancy, fire-containment, and anti-failure features.
  - NEC devices are classified into the following three quality grades:  
"Standard", "Special", and "Specific". The Specific quality grade applies only to devices developed based on a customer designated "quality assurance program" for a specific application. The recommended applications of a device depend on its quality grade, as indicated below. Customers must check the quality grade of each device before using it in a particular application.
    - Standard: Computers, office equipment, communications equipment, test and measurement equipment, audio and visual equipment, home electronic appliances, machine tools, personal electronic equipment and industrial robots
    - Special: Transportation equipment (automobiles, trains, ships, etc.), traffic control systems, anti-disaster systems, anti-crime systems, safety equipment and medical equipment (not specifically designed for life support)
    - Specific: Aircraft, aerospace equipment, submersible repeaters, nuclear reactor control systems, life support systems or medical equipment for life support, etc.
- The quality grade of NEC devices is "Standard" unless otherwise specified in NEC's Data Sheets or Data Books. If customers intend to use NEC devices for applications other than those specified for Standard quality grade, they should contact an NEC sales representative in advance.