



# STN2NF06L

## N-CHANNEL 60V - 0.1 Ω - 2A SOT-223 STripFET™ II POWER MOSFET

TYPE	V <sub>DSS</sub>	R <sub>DS(on)</sub>	I <sub>D</sub>
STN2NF06L	60 V	<0.12 Ω	2 A

- TYPICAL R<sub>DS(on)</sub> = 0.1 Ω
- EXTREMELY HIGH dv/dt CAPABILITY
- 100% AVALANCHE TESTED
- AVALANCHE RUGGED TECHNOLOGY
- LOW THRESHOLD DRIVE

### DESCRIPTION

This Power MOSFET is the latest development of STMicroelectronics unique "Single Feature Size™" strip-based process. The resulting transistor shows extremely high packing density for low on-resistance, rugged avalanche characteristics and less critical alignment steps therefore a remarkable manufacturing reproducibility.

### APPLICATIONS

- DC MOTOR CONTROL (DISK DRIVES, etc.)
- DC-DC & DC-AC CONVERTERS
- SYNCHRONOUS RECTIFICATION

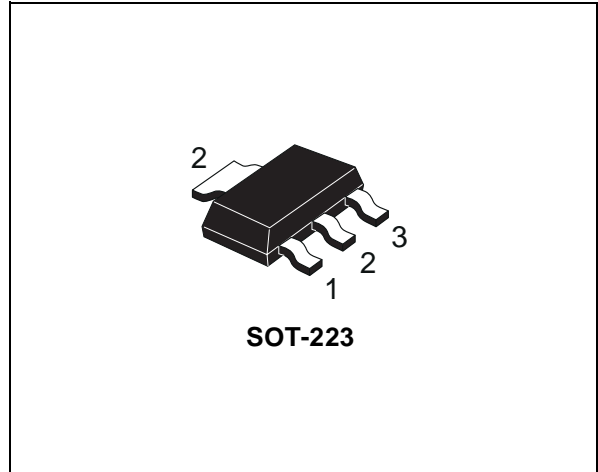

### INTERNAL SCHEMATIC DIAGRAM

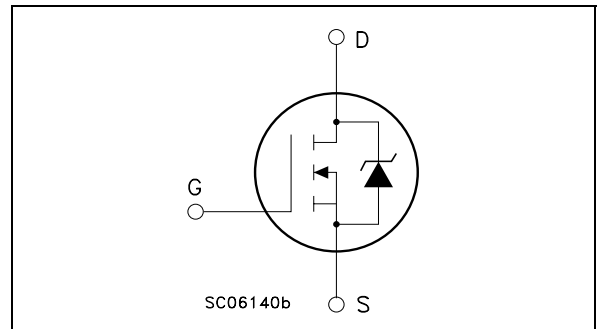

### ABSOLUTE MAXIMUM RATINGS

Symbol	Parameter	Value	Unit
V <sub>DS</sub>	Drain-source Voltage (V <sub>GS</sub> = 0)	60	V
V <sub>DGR</sub>	Drain-gate Voltage (R <sub>GS</sub> = 20 kΩ)	60	V
V <sub>GS</sub>	Gate- source Voltage	± 16	V
I <sub>D</sub>	Drain Current (continuous) at T <sub>C</sub> = 25°C	2	A
I <sub>D</sub>	Drain Current (continuous) at T <sub>C</sub> = 100°C	1.2	A
I <sub>DM</sub> (●)	Drain Current (pulsed)	8	A
P <sub>tot</sub> (1)	Total Dissipation at T <sub>C</sub> = 25°C	3	W
	Derating Factor	8	W/°C
dv/dt (2)	Peak Diode Recovery voltage slope	6	V/ns
E <sub>AS</sub> (3)	Single Pulse Avalanche Energy	200	mJ
T <sub>stg</sub>	Storage Temperature	-55 to 150	°C
T <sub>j</sub>	Max. Operating Junction Temperature		°C

(●) Pulse width limited by safe operating area.

(1) Related to R<sub>thj -i</sub>

(2) I<sub>SD</sub> ≤ 2A, di/dt ≤ 100A/μs, V<sub>DD</sub> ≤ V(BR)DSS, T<sub>j</sub> ≤ T<sub>JMAX</sub>

(3) Starting T<sub>j</sub> = 25 °C, I<sub>D</sub> = 2A, V<sub>DD</sub> = 30V

## STN2NF06L

### THERMAL DATA

Rthj-pcb	Thermal Resistance Junction-PCB(1 inch <sup>2</sup> copper board)	50	°C/W
Rthj-pcb	Thermal Resistance Junction-PCB (min. footprint)	90	°C/W
T <sub>l</sub>	Maximum Lead Temperature For Soldering Purpose	260	°C

### ELECTRICAL CHARACTERISTICS (T<sub>case</sub> = 25 °C unless otherwise specified)

OFF

Symbol	Parameter	Test Conditions	Min.	Typ.	Max.	Unit
V <sub>(BR)DSS</sub>	Drain-source Breakdown Voltage	I <sub>D</sub> = 250 μA, V <sub>GS</sub> = 0	60			V
I <sub>DSS</sub>	Zero Gate Voltage Drain Current (V <sub>GS</sub> = 0)	V <sub>DS</sub> = Max Rating V <sub>DS</sub> = Max Rating T <sub>C</sub> = 125°C			1 10	μA μA
I <sub>GSS</sub>	Gate-body Leakage Current (V <sub>DS</sub> = 0)	V <sub>GS</sub> = ± 16 V			±100	nA

ON (\*)

Symbol	Parameter	Test Conditions	Min.	Typ.	Max.	Unit
V <sub>GS(th)</sub>	Gate Threshold Voltage	V <sub>DS</sub> = V <sub>GS</sub> I <sub>D</sub> = 250 μA	1			V
R <sub>DS(on)</sub>	Static Drain-source On Resistance	V <sub>GS</sub> = 10 V I <sub>D</sub> = 1 A V <sub>GS</sub> = 5 V I <sub>D</sub> = 1 A		0.1 0.12	0.12 0.14	Ω Ω

DYNAMIC

Symbol	Parameter	Test Conditions	Min.	Typ.	Max.	Unit
g <sub>fs</sub> (*)	Forward Transconductance	V <sub>DS</sub> = 15 V I <sub>D</sub> = 1 A		3		S
C <sub>iss</sub>	Input Capacitance	V <sub>DS</sub> = 25V f = 1 MHz V <sub>GS</sub> = 0		360		pF
C <sub>oss</sub>	Output Capacitance			55		pF
C <sub>rss</sub>	Reverse Transfer Capacitance			25		pF

**ELECTRICAL CHARACTERISTICS** (continued)

**SWITCHING ON**

Symbol	Parameter	Test Conditions	Min.	Typ.	Max.	Unit
$t_{d(on)}$ $t_r$	Turn-on Time Rise Time	$V_{DD} = 30\text{ V}$ $I_D = 1\text{ A}$ $R_G = 4.7\ \Omega$ $V_{GS} = 4.5\text{ V}$ (Resistive Load, Figure 3)		10 20		ns ns
$Q_g$ $Q_{gs}$ $Q_{gd}$	Total Gate Charge Gate-Source Charge Gate-Drain Charge	$V_{DD} = 48\text{ V}$ $I_D = 2\text{ A}$ $V_{GS} = 5\text{ V}$		5.6 1.2 2.6	7.6	nC nC nC

**SWITCHING OFF**

Symbol	Parameter	Test Conditions	Min.	Typ.	Max.	Unit
$t_{d(off)}$ $t_f$	Turn-off Delay Time Fall Time	$V_{DD} = 30\text{ V}$ $I_D = 1\text{ A}$ $R_G = 4.7\ \Omega$ , $V_{GS} = 4.5\text{ V}$ (Resistive Load, Figure 3)		17 6		ns ns

**SOURCE DRAIN DIODE**

Symbol	Parameter	Test Conditions	Min.	Typ.	Max.	Unit
$I_{SD}$ $I_{SDM} (\bullet)$	Source-drain Current Source-drain Current (pulsed)				2 8	A A
$V_{SD} (^*)$	Forward On Voltage	$I_{SD} = 2\text{ A}$ $V_{GS} = 0$			1.3	V
$t_{rr}$ $Q_{rr}$ $I_{RRM}$	Reverse Recovery Time Reverse Recovery Charge Reverse Recovery Current	$I_{SD} = 2\text{ A}$ $di/dt = 100\text{ A}/\mu\text{s}$ $V_{DD} = 20\text{ V}$ $T_j = 150^\circ\text{C}$ (see test circuit, Figure 5)		28 31 2.2		ns nC A

(\*)Pulsed: Pulse duration = 300  $\mu\text{s}$ , duty cycle 1.5 %.  
 (•)Pulse width limited by safe operating area.

**Safe Operating Area**

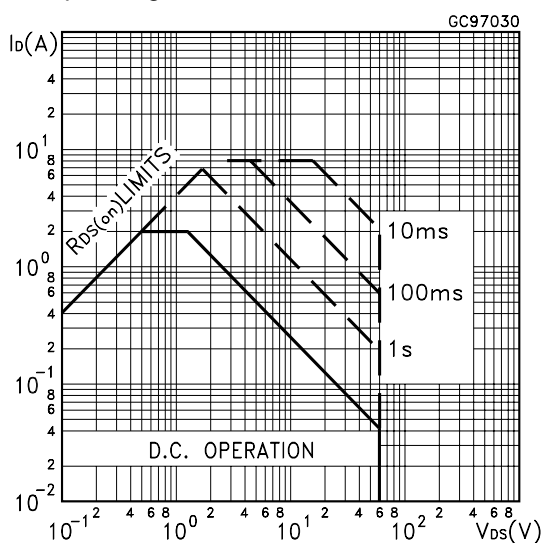

**Thermal Impedance Junction-lead**

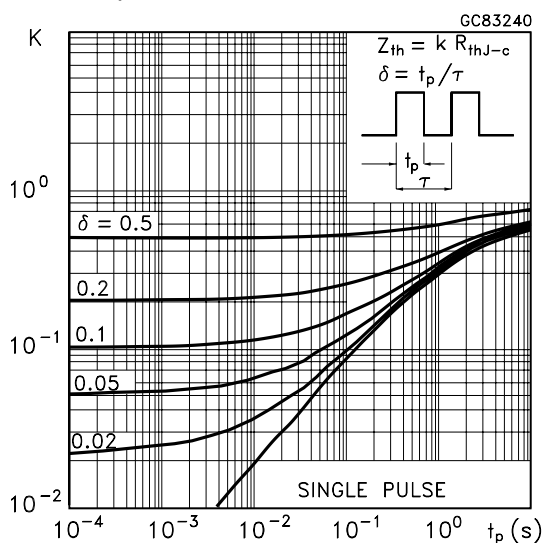

# STN2NF06L

Output Characteristics

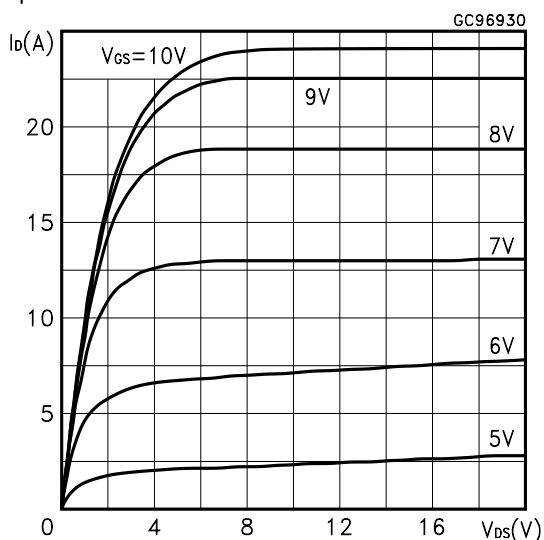

Transfer Characteristics

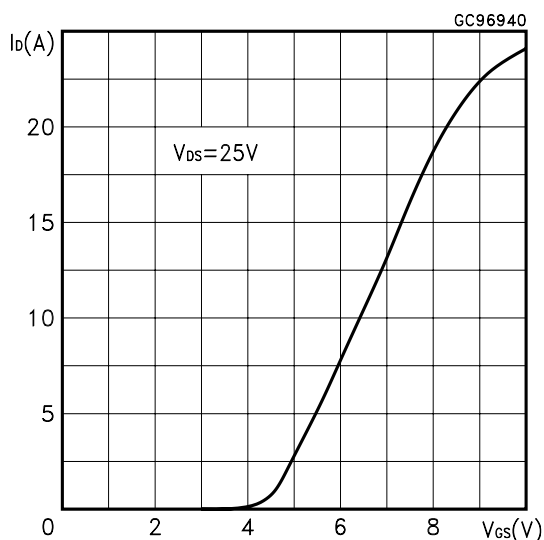

Transconductance

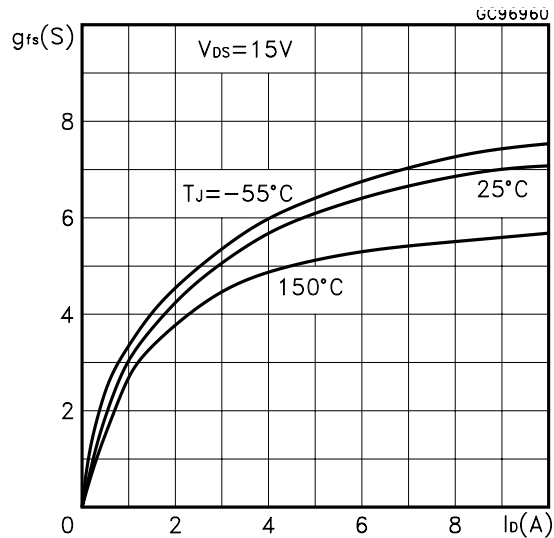

Static Drain-source On Resistance

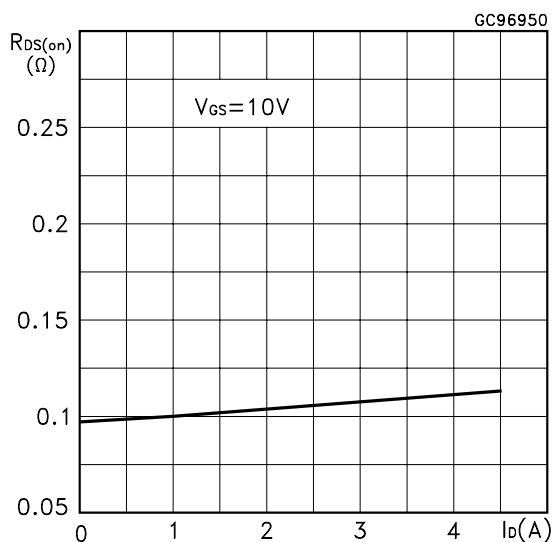

Gate Charge vs Gate-source Voltage

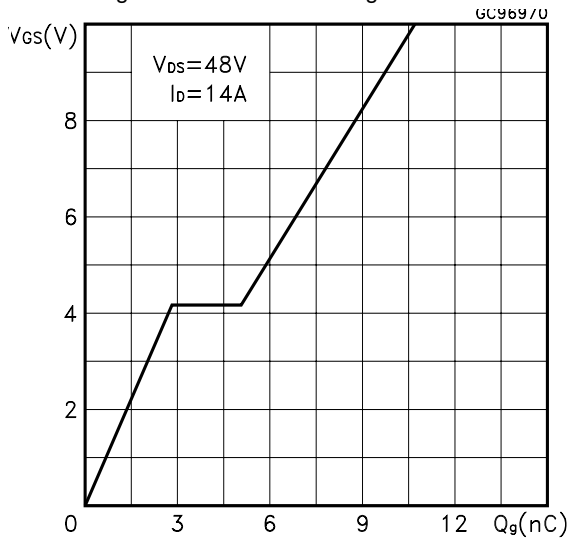

Capacitance Variations

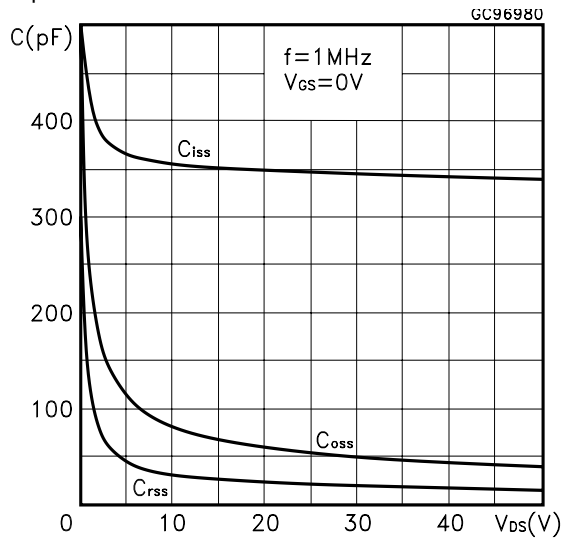

Normalized Gate Threshold Voltage vs Temperature

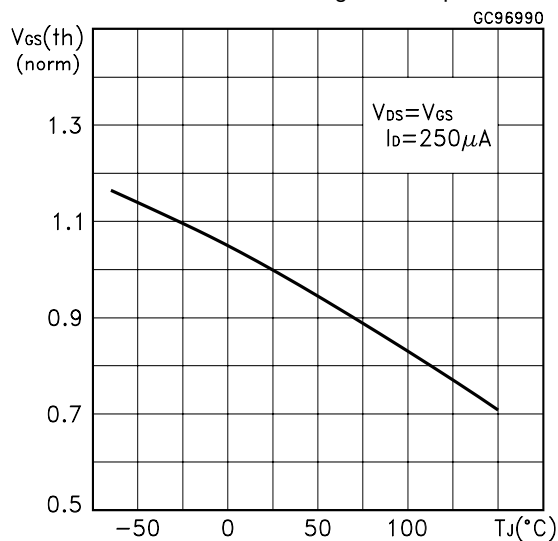

Normalized on Resistance vs Temperature

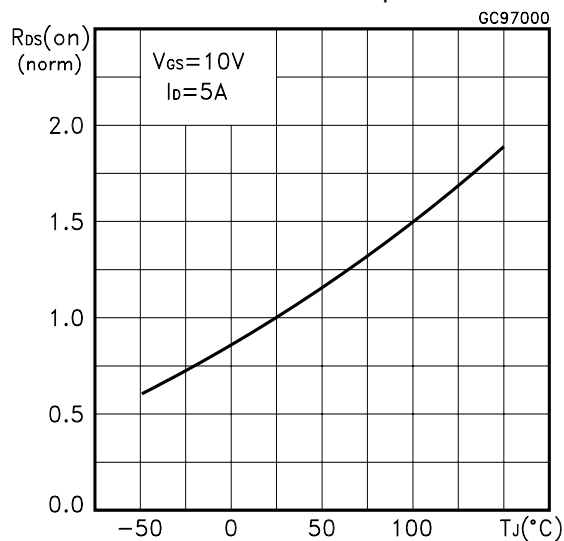

Source-drain Diode Forward Characteristics

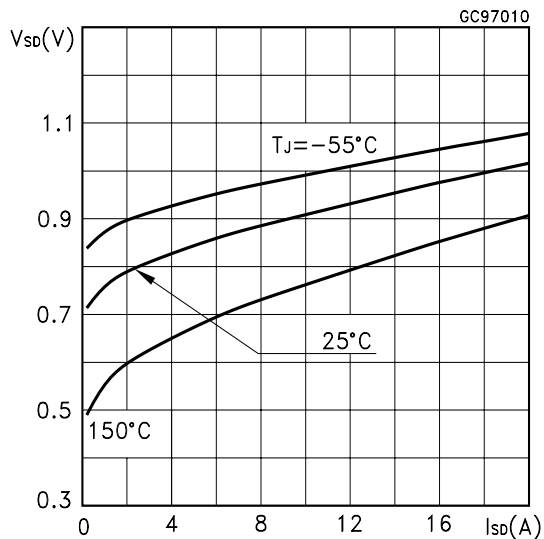

Normalized Breakdown Voltage vs Temperature.

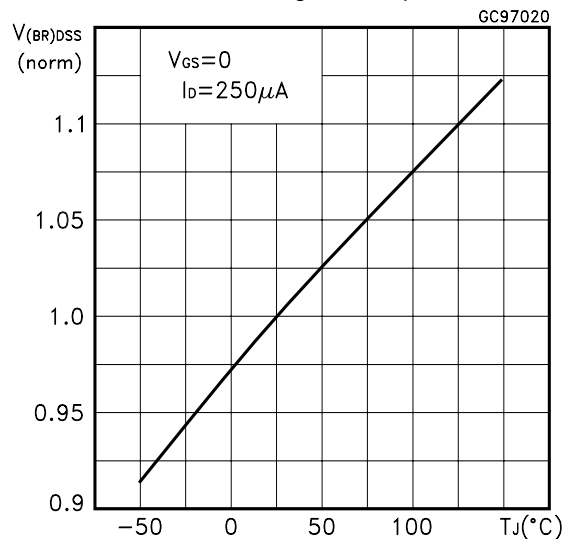

Fig. 1: Unclamped Inductive Load Test Circuit



Fig. 2: Unclamped Inductive Waveform



Fig. 3: Switching Times Test Circuits For Resistive Load



Fig. 4: Gate Charge test Circuit

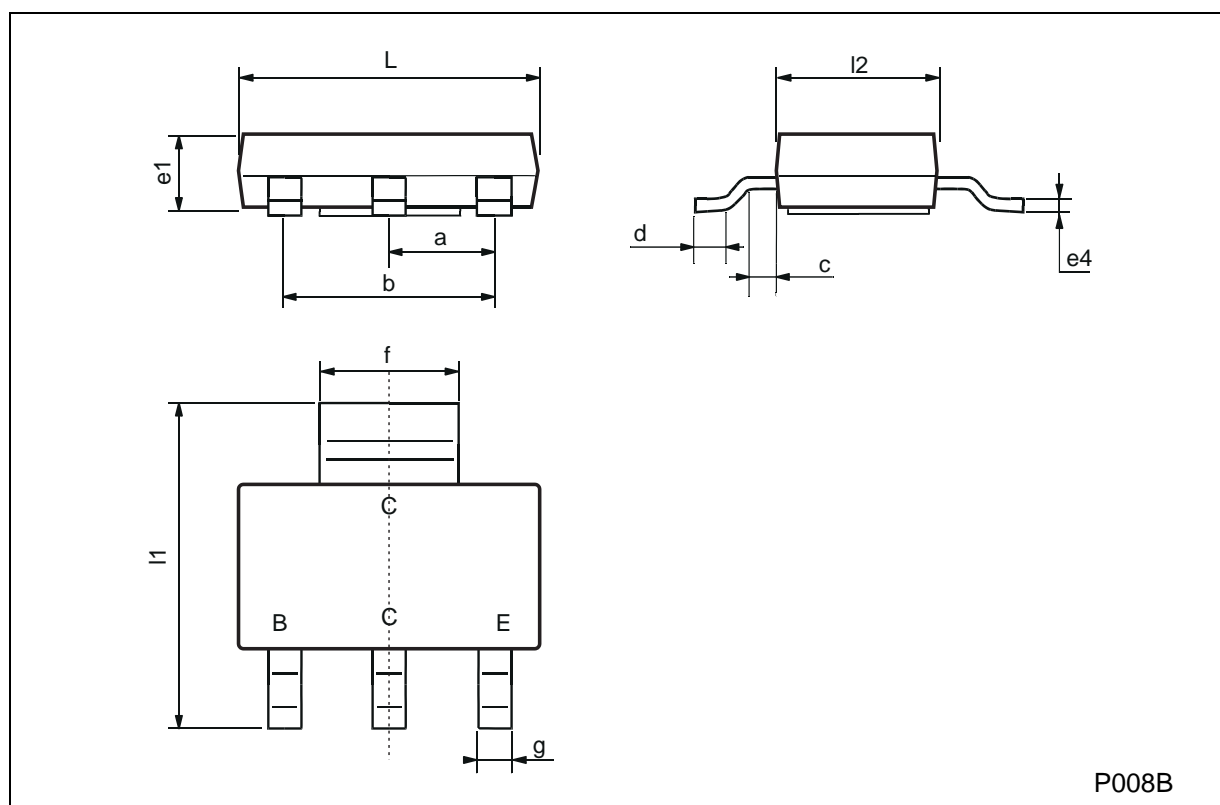

Fig. 5: Test Circuit For Inductive Load Switching And Diode Recovery Times



## SOT-223 MECHANICAL DATA

DIM.	mm			mils		
	MIN.	TYP.	MAX.	MIN.	TYP.	MAX.
a	2.27	2.3	2.33	89.4	90.6	91.7
b	4.57	4.6	4.63	179.9	181.1	182.3
c	0.2	0.4	0.6	7.9	15.7	23.6
d	0.63	0.65	0.67	24.8	25.6	26.4
e1	1.5	1.6	1.7	59.1	63	66.9
e4			0.32			12.6
f	2.9	3	3.1	114.2	118.1	122.1
g	0.67	0.7	0.73	26.4	27.6	28.7
l1	6.7	7	7.3	263.8	275.6	287.4
l2	3.5	3.5	3.7	137.8	137.8	145.7
L	6.3	6.5	6.7	248	255.9	263.8



Information furnished is believed to be accurate and reliable. However, STMicroelectronics assumes no responsibility for the consequences of use of such information nor for any infringement of patents or other rights of third parties which may result from its use. No license is granted by implication or otherwise under any patent or patent rights of STMicroelectronics. Specifications mentioned in this publication are subject to change without notice. This publication supersedes and replaces all information previously supplied. STMicroelectronics products are not authorized for use as critical components in life support devices or systems without express written approval of STMicroelectronics.

The ST logo is registered trademark of STMicroelectronics  
© 2002 STMicroelectronics - All Rights Reserved

All other names are the property of their respective owners.

STMicroelectronics GROUP OF COMPANIES

Australia - Brazil - Canada - China - Finland - France - Germany - Hong Kong - India - Israel - Italy - Japan - Malaysia - Malta - Morocco -  
Singapore - Spain - Sweden - Switzerland - United Kingdom - United States.

<http://www.st.com>