

Features

- High Capacitance Ratio,
 $C_{0.3\text{ V}}/C_{4.7\text{ V}} = 12$ Typ.
- Multiple Packages SOT-23, SOD-323,
SC-70 and SC-79
- Designed for High Volume Commercial
Applications
- SPICE Models are Available

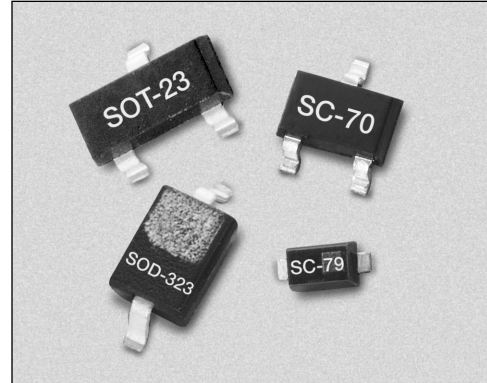

Description

The SMV1247–SMV1255 series of silicon hyperabrupt junction varactor diodes are designed for use in VCOs with low tuning voltage operation. This family of varactors is characterized for capacitance and resistance over temperature. SPICE models are provided.

Absolute Maximum Ratings

Characteristic	Value
Reverse Voltage (V_R)	15 V
Forward Current (I_F)	20 mA
Power Dissipation (P_D)	250 mW
Storage Temperature (T_{ST})	-55°C to +150°C
Operating Temperature (T_{OP})	-55°C to +125°C

Single	Single	Single	Common Anode	Common Cathode	Common Anode	Common Cathode
SC-79	SOD-323	SOT-23	SOT-23	SOT-23	SC-70	SC-70
◆ SMV1247-079						◆ SMV1247-074
		◆ SMV1248-001				
◆ SMV1249-079	◆ SMV1249-011	◆ SMV1249-001	◆ SMV1249-003		◆ SMV1249-073	
◆ SMV1251-079	◆ SMV1251-011	◆ SMV1251-001		◆ SMV1251-004		◆ SMV1251-074
◆ SMV1253-079				◆ SMV1253-004		
◆ SMV1255-079	◆ SMV1255-011	◆ SMV1255-001	◆ SMV1255-003	◆ SMV1255-004	◆ SMV1255-073	
$L_S = 0.7$ nH	$L_S = 1.5$ nH	$L_S = 1.5$ nH	$L_S = 1.5$ nH	$L_S = 1.5$ nH	$L_S = 1.4$ nH	$L_S = 1.4$ nH

◆ Available through distribution.
For other packages or configurations, please contact the factory.

Electrical Specifications at 25°C

Part Number	C_T @ 0.3 V (pF)		C_T @ 4.7 V (pF)		C_T @ 1 V (pF)	C_T @ 3 V (pF)	$\frac{C_T @ 0.3 V}{C_T @ 4.7 V}$ (Ratio)		$\frac{C_T @ 1 V}{C_T @ 3 V}$ (Ratio)	$R_S @ 3 V$ 500 MHz (Ω)	$Q @ 3 V$ 50 MHz
	Min.	Typ.	Typ.	Max.	Typ.	Typ.	Min.	Typ.	Typ.	Max.	Typ.
SMV1247	6.5	7	0.7	0.78	4.4	0.95	9.5	10.0	4.6	2.0	1500
SMV1248	15.0	17	1.5	1.70	12.3	2.60	10.8	12.0	4.7	1.8	700
SMV1249	28.0	31	2.6	2.80	18.2	3.40	11.0	12.1	5.3	1.5	600
SMV1251	38.0	42	3.4	3.80	28.1	5.80	11.0	12.2	4.8	1.3	400
SMV1253	48.0	53	4.3	4.80	37.0	7.80	11.0	12.3	4.7	1.2	350
SMV1255	58.0	64	5.2	5.80	43.3	8.50	11.0	12.3	5.1	1.0	350

Reverse Voltage V_R ($I_R = 10 \mu A$): 15 V
 Reverse Current I_R ($V_R = 12 V$): 20 nA

Typical Performance Data

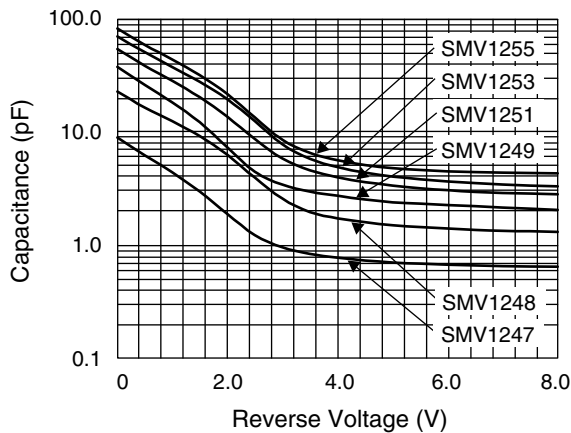

Capacitance vs. Reverse Voltage

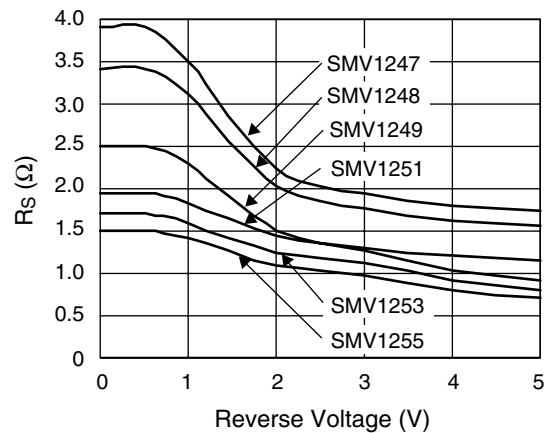

Series Resistance vs. Reverse Voltage @ 500 MHz

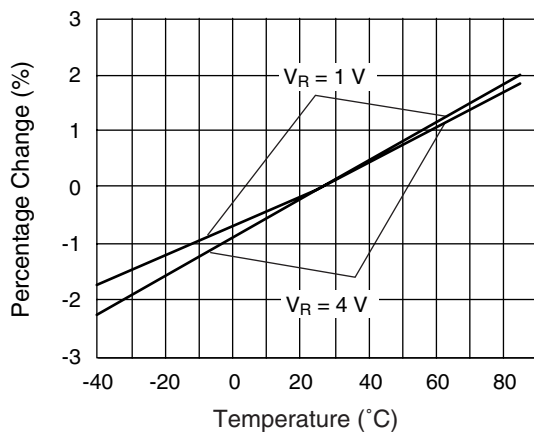

Relative Capacitance Change vs. Temperature

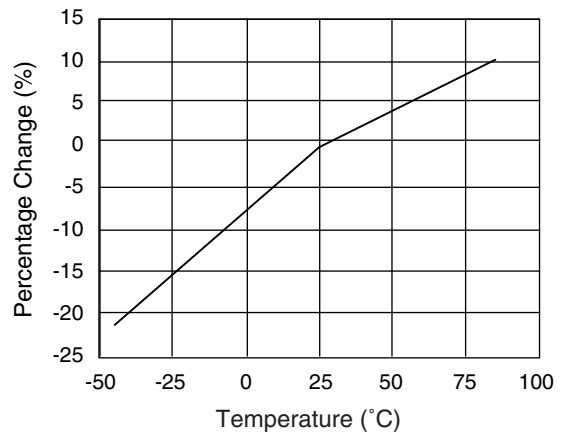

Relative Series Resistance Change vs. Temperature @ 500 MHz

Typical Capacitance Values

V_R (V)	SMV1247	SMV1248	SMV1249	SMV1251	SMV1253	SMV1255
	C_T (pF)	C_T (pF)	C_T (pF)	C_T (pF)	C_T (pF)	C_T (pF)
0.0	8.86	22.62	37.35	53.65	69.32	81.21
0.5	6.17	16.32	25.88	38.23	50.23	58.28
1.0	4.37	12.33	18.18	28.09	37.07	43.27
1.5	2.96	9.12	12.08	20.13	27.57	31.49
2.0	1.88	6.27	7.27	13.55	19.37	21.50
2.5	1.22	3.93	4.44	8.60	12.39	13.40
3.0	0.95	2.57	3.40	5.78	7.77	8.51
3.5	0.83	1.95	2.96	4.57	5.77	6.51
4.0	0.77	1.71	2.72	3.95	4.86	5.58
4.5	0.73	1.59	2.51	3.58	4.34	5.07
5.0	0.70	1.49	2.38	3.33	4.01	4.76
5.5	0.68	1.44	2.30	3.16	3.78	4.58
6.0	0.67	1.40	2.24	3.03	3.62	4.46
6.5	0.66	1.36	2.19	2.94	3.50	4.39
7.0	0.65	1.33	2.14	2.88	3.41	4.33
7.5	0.64	1.31	2.09	2.83	3.34	4.29
8.0	0.64	1.30	2.03	2.79	3.28	4.26

SPICE Model

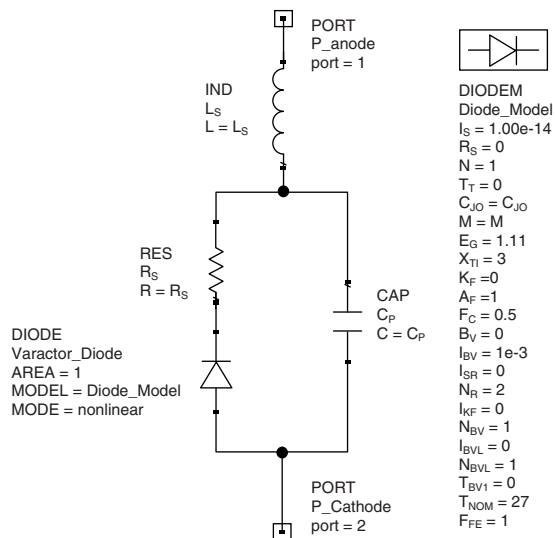

Part Number	C_{JO} (pF)	V_J (V)	M	C_P (pF)	R_S (Ω)
SMV1247	9.22	13	10.5	0	2.0
SMV1248	21.54	17	14.0	0	1.8
SMV1249	39.00	17	14.0	0	1.5
SMV1250	47.00	17	14.0	0	1.5
SMV1251	60.00	17	14.0	0	1.3
SMV1253	70.00	17	14.0	0	1.2
SMV1255	82.00	17	14.0	0	1.0

1. Values extracted from measured performance.
2. For package inductance (L_S) refer to package type.
3. For more details refer to the "Varactor SPICE Models for RF VCO Applications" Application Note.

SOT-23

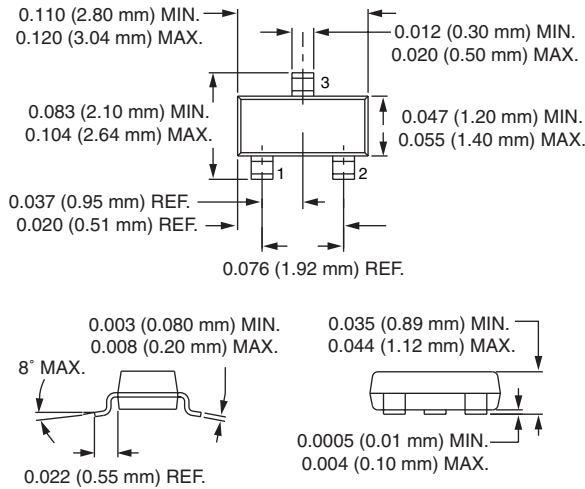

SC-70

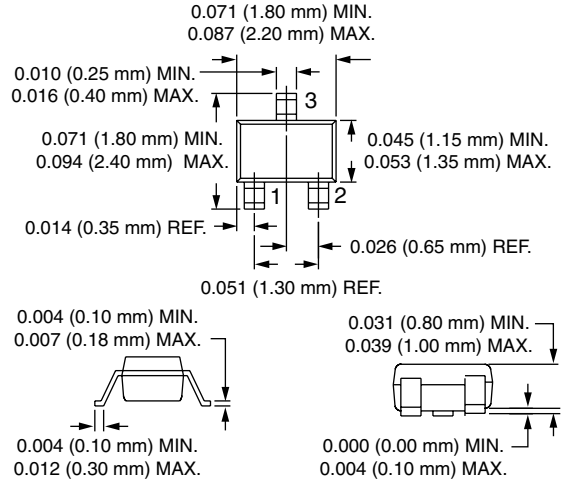

SOD-323

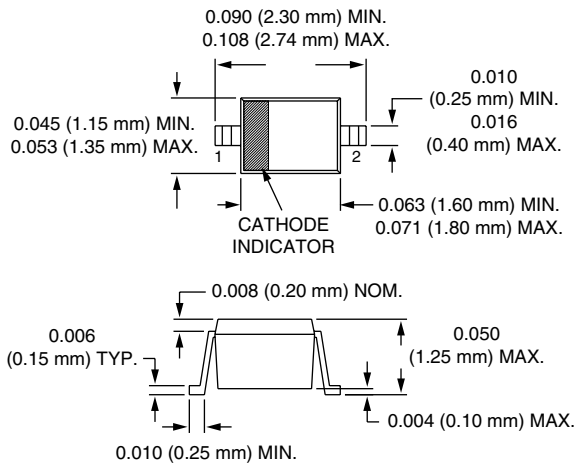

SC-79

