

POWER MANAGEMENT

Description

The SC1531(A) is designed to maintain a glitch-free 3.3V output when at least one of two inputs, 5V (VIN) and 3.3V (VAUX), is present.

Whenever VIN exceeds a predetermined threshold value, the internal 3.3V linear regulator is enabled, and DR is pulled high.

When VIN falls below a lower threshold value, DR is pulled low and the internal linear regulator is turned off. DR has been designed to drive the gate of an external low threshold P-channel MOSFET, which can be used to connect the 3.3V supply directly to the regulator output. This ensures an uninterrupted 3.3V output even if VIN falls out of specification. A typical $R_{DS(ON)}$ of 400mΩ is recommended (320mΩ for SC1531A).

When both supplies are simultaneously available, the drive pin (DR) will be pulled High, turning off the external PMOS switch.

The internal 5V detector has its upper threshold (for VIN rising) set to 4.18V (typical) while the lower threshold (for VIN falling) is at 4.05V (typical) giving a hysteresis of approximately 130mV.

The SENSE pin, which is connected to the load, connects internally to the inverting input of the LDO error amplifier. It enables tight regulation of the load voltage (while the 5V supply is present) despite variations in load current.

The SC1531(A) is available in the popular SO-8 surface mount package.

Typical Application Circuit

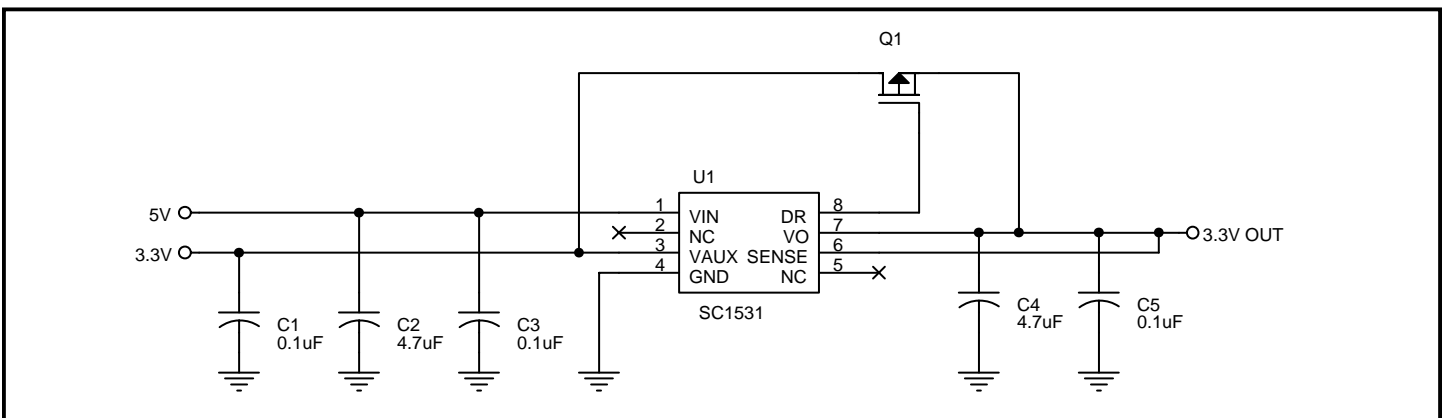

Features

- ◆ Glitch-free transition between input sources
- ◆ Internal logic selects input source
- ◆ Gate drive for external PMOS bypass switch
- ◆ 5V detection with hysteresis
- ◆ 1% regulated output voltage accuracy
- ◆ 200mA load current capability (250mA for SC1531A)
- ◆ Remote sense
- ◆ SO-8 package

Applications

- ◆ Desktop Computers
- ◆ Network Interface Cards (NICs)
- ◆ PCMCIA/PCI Interface Cards
- ◆ Cardbus™ Technology
- ◆ Power supplies with multiple input sources

Notes for Typical Application Circuit:

- (1) External switch (Q1): use Motorola MGSF1P02ELT1 or equivalent (PMOS, typical Gate Threshold Voltage = 1V, typical $R_{DS(ON)}$ = 0.4Ω at V_{GS} = 2.5V) for SC1531. Use Vishay Si2301DS or equivalent for SC1531A.
- (2) Connection of VAUX (pin 3) is optional.

POWER MANAGEMENT
Absolute Maximum Rating

Parameter	Symbol	Maximum	Units
Input Supply Voltage	V _{IN}	-0.5 to +7	V
Auxiliary Supply Voltage	V _{AUX}	-0.5 to +7	V
LDO Output Current (SC1531)	I _o	200	mA
LDO Output Current (SC1531A)	I _o	250	mA
Thermal Impedance Junction to Ambient	θ _{JA}	130	°C/W
Thermal Impedance Junction to Case	θ _{JC}	47	°C/W
Operating Ambient Temperature Range	T _A	-5 to +70	°C
Operating Junction Temperature Range	T _J	-5 to +125	°C
Storage Temperature Range	T _{STG}	-65 to +150	°C
Lead Temperature (Soldering) 10 Sec.	T _{LEAD}	300	°C
ESD Rating	V _{ESD}	2	kV

Electrical Characteristics

Unless specified: T_A = 25°C, V_{IN} = 5V, V_{AUX} = 3.3V, I_o = max. rated, C_o = 4.7µF. Values in **bold** apply over full operating temperature range.

Parameter	Symbol	Test Conditions	Min	Typ	Max	Units
VIN						
Supply Voltage	V _{IN}	V _{AUX} = 0V	4.3	5.0	5.5	V
Quiescent Current	I _o	V _{IN} = 5V, V _{AUX} = 0V, I _o = 0mA		7.0	10.0	mA
				11.0		
		V _{IN} = 5V, V _{AUX} = 3.3V, I _o = 0mA		7.5	10.0	mA
					12.0	
Reverse Leakage From V _{AUX}	I _{VIN}	V _{AUX} = 3.6V, V _{IN} = 0V, I _o = 0mA		1.0	10	µA
					20	
V_{AUX}						
Supply Voltage	V _{AUX}		3.0	3.3	3.6	V
Quiescent Current	I _{Q(AUX)}	V _{AUX} = 3.3V, V _{IN} = 0V, I _o = 0mA		0.8	1.5	mA
				2.0		
		V _{AUX} = 3.3V, V _{IN} = 5V, I _o = 0mA		0.6	1.0	mA
					2.0	
Reverse Leakage From V _{IN}	I _{V_{AUX}}	V _{IN} = 5.5V, V _{AUX} = 0V, I _o = 0mA		7	50	µA
					100	

POWER MANAGEMENT
Electrical Characteristics (Cont.)

 Unless specified: $T_A = 25^\circ\text{C}$, $V_{IN} = 5\text{V}$, $V_{AUX} = 3.3\text{V}$, $I_o = \text{max. rated}$, $C_o = 4.7\mu\text{F}$. Values in **bold** apply over full operating temperature range.

Parameter	Symbol	Test Conditions	Min	Typ	Max	Units
5V Detect⁽¹⁾⁽²⁾⁽³⁾						
Low Threshold Voltage	$V_{TH(LO)}$	VIN Falling	3.90	4.05	4.20	V
Hysteresis	V_{HYST}		90	200		mV
			80			
High Threshold Voltage	$V_{TH(HI)}$	VIN Rising			4.30	V
VO						
LDO Output Voltage	VO	$I_o = 20\text{mA}$	3.267	3.300	3.333	V
		$4.3\text{V} \leq V_{IN} \leq 5.5\text{V}$, $0\text{mA} \leq I_o \leq I_{O(MAX)}$	3.234		3.366	
		$3.9\text{V} \leq V_{IN} \leq 4.3\text{V}$, $V_{AUX} = 3.3\text{V}$, $0\text{mA} \leq I_o \leq I_{O(MAX)}$ ⁽⁴⁾	3.000			
Line Regulation	$REG_{(LINE)}$	VIN = 4.3V to 5.5V		0.12	0.40	%
					0.60	
Load Regulation	$REG_{(LOAD)}$	$I_o = 20\text{mA}$ to $I_{O(MAX)}$		0.12	0.40	%
					0.60	
SENSE						
SENSE Pin Impedance	R_{SENSE}		6.0	8.5		k Ω
DR						
Drive Voltage	V_{DR}	$4.3\text{V} \leq V_{IN} \leq 5.5\text{V}$, $I_{DR} = 200\mu\text{A}$	3.4	VIN - 0.8		V
			3.3			
		$V_{IN} < V_{TH(LO)}$, $I_{DR} = -200\mu\text{A}$		35	150	mV
					200	
Peak Drive Current	$I_{DR(PK)}$	Sinking: VIN = 3.9V, $V_{DR} = 1\text{V}$;	7			mA
		Sourcing: VIN = 4.3V, $(V_{IN} - V_{DR}) = 2\text{V}$	6			
Drive High Delay ⁽¹⁾⁽⁵⁾	t_{DH}	$C_{DR} = 1.2\text{nF}$, VIN ramping up, measured from VIN = $V_{TH(HI)}$ to $V_{DR} = 2\text{V}$		0.5	1.0	μs
					2.0	
Drive Low Delay ⁽¹⁾⁽⁵⁾	t_{DL}	$C_{DR} = 1.2\text{nF}$, VIN ramping down, measured from VIN = $V_{TH(LO)}$ to $V_{DR} = 2\text{V}$		0.5	1.0	μs
					2.0	

 See next page for **Notes**.

POWER MANAGEMENT
Electrical Characteristics (Cont.)
Notes:

- (1) Guaranteed by design.
- (2) See 5V Detect Thresholds below.
- (3) Recommended source impedance for 5V supply: $\leq 0.25\Omega$ (0.2Ω for SC1531A). This will ensure that $I_o \times R_{SOURCE} < V_{HYST}$, thus avoiding DR toggling during 5V detect threshold transitions.
- (4) In Application Circuit on page 1.
- (5) See Timing Diagram below.

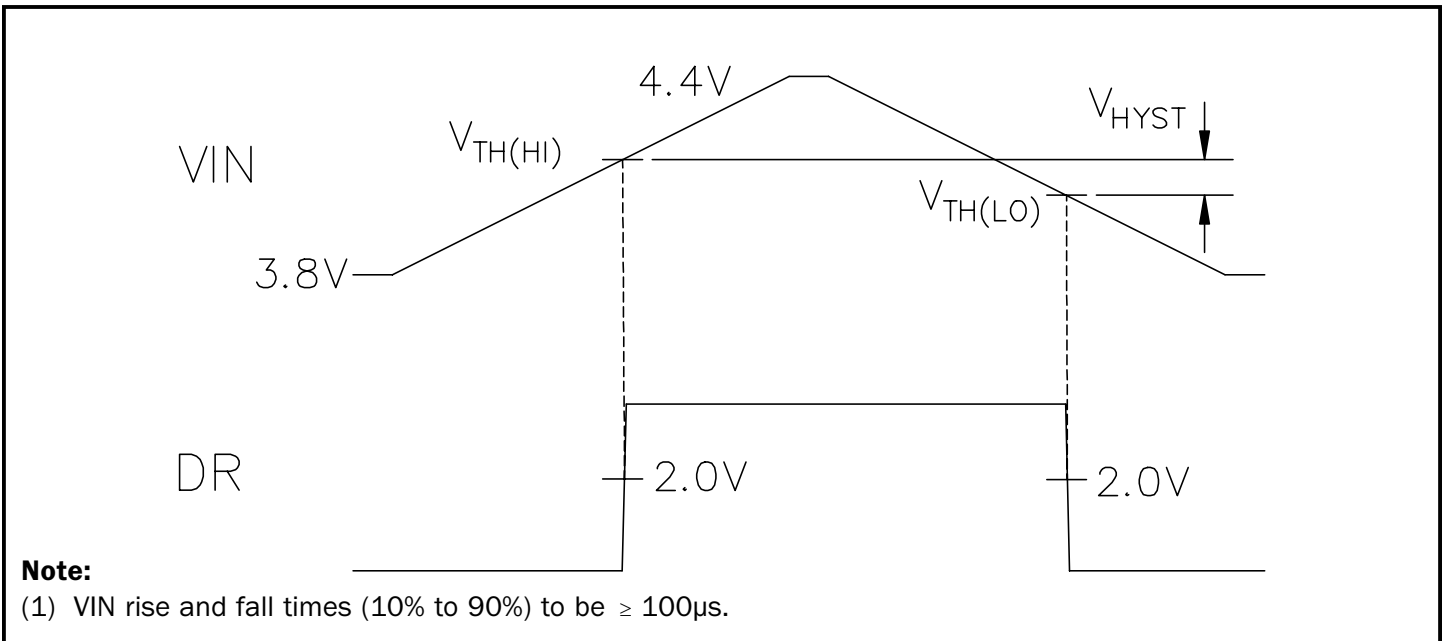
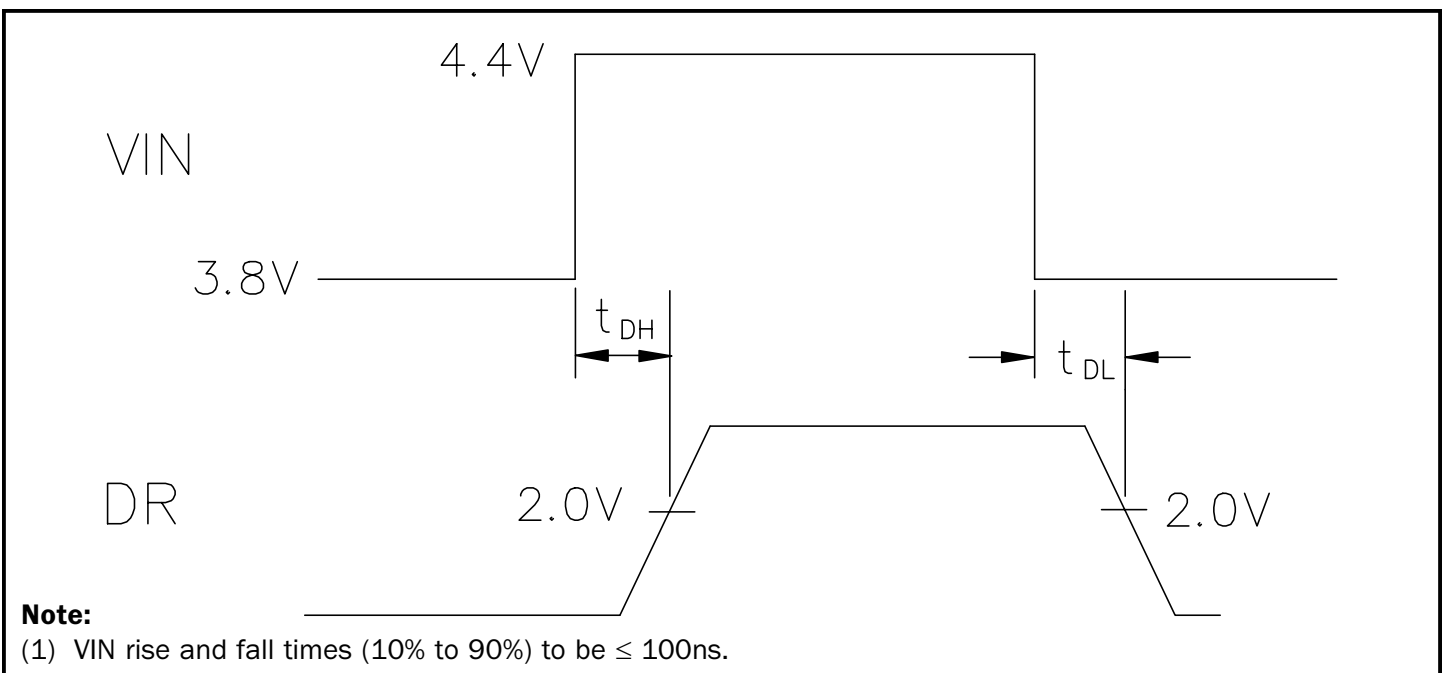
5V Detect Thresholds⁽¹⁾

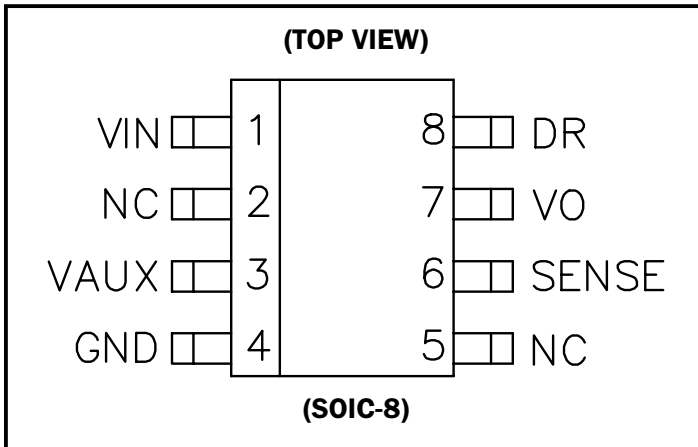
Timing Diagram⁽¹⁾

POWER MANAGEMENT
Pin Configuration

Ordering Information

Part Number ⁽¹⁾	Output Current	Package
SC1531CS.TR	200mA	SO-8
SC1531ACS.TR	250mA	SO-8

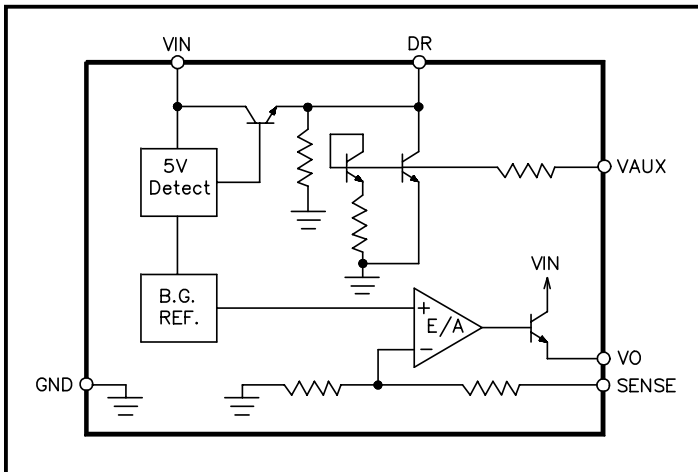
Note:

(1) Only available in tape and reel packaging. A reel contains 2500 devices.

Block Diagram

Pin Descriptions

Pin	Pin Name	Pin Function
1	VIN	This is the main input supply for the IC, nominally 5V.
2	NC	No connection.
3	VAUX	This is the auxiliary input supply, nominally 3.3V. Connection of this pin is optional, and will slightly improve the turn-on time of the external MOSFET. Leave floating if not used.
4	GND	Logic and power ground.
5	NC	No connection.
6	SENSE	Sense pin for VO. Connect to VO at the load to minimize voltage drop across PCB traces. If remote sense function is not required, connect directly to pin 7.
7	VO	LDO 3.3V output.
8	DR	Driver output for external P-channel MOSFET pass element.

POWER MANAGEMENT

Typical Characteristics

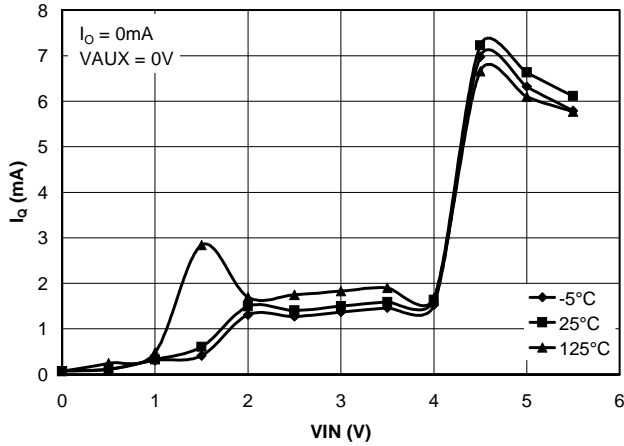
**Quiescent Current vs. Main Input Voltage
vs. Junction Temperature, VAUX = 0V**



**Quiescent Current vs. Main Input Voltage
vs. Junction Temperature, VAUX = 3.3V**

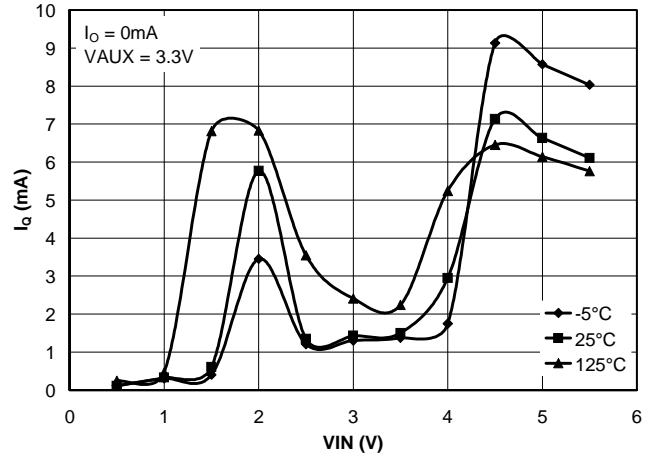

**Auxiliary Quiescent Current vs. Auxiliary Input Voltage
vs. Junction Temperature, VIN = 0V**

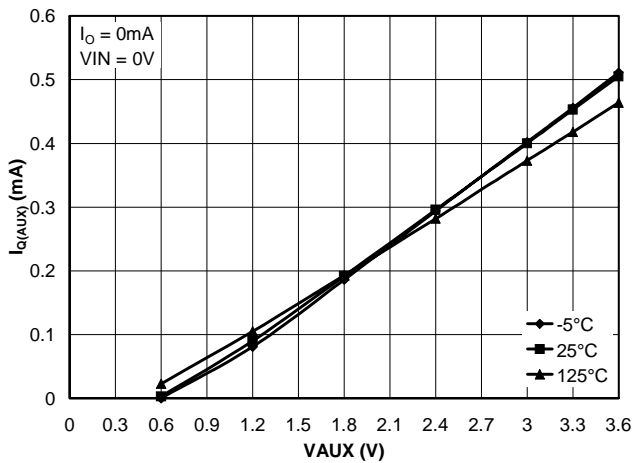

**Auxiliary Quiescent Current vs. Auxiliary Input Voltage
vs. Junction Temperature, VIN = 5V**

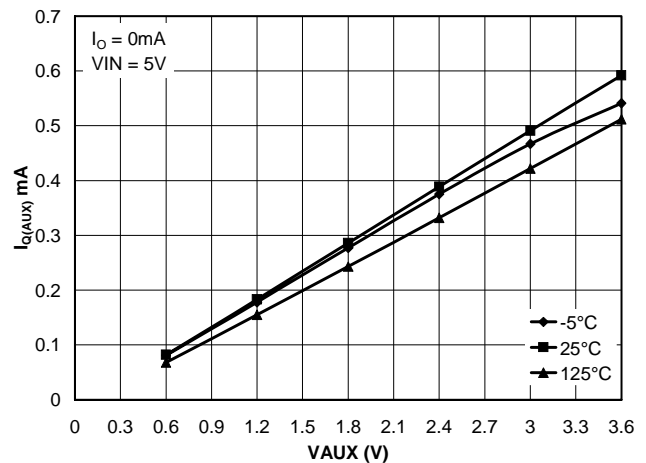

**LDO Output Voltage vs.
Junction Temperature**

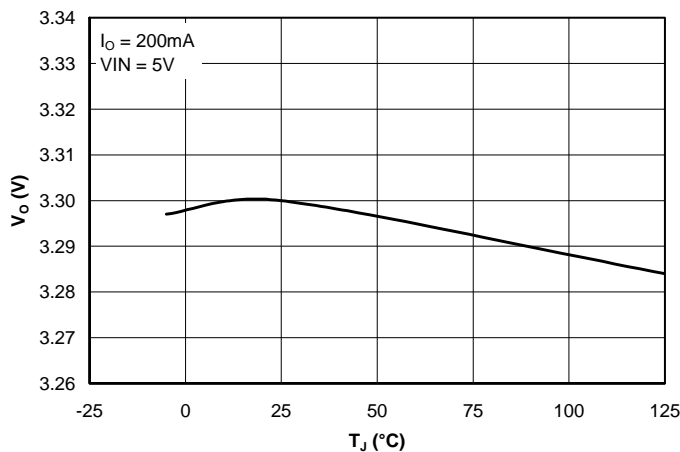

POWER MANAGEMENT

Typical Characteristics (Cont.)⁽¹⁾

Drive High Delay

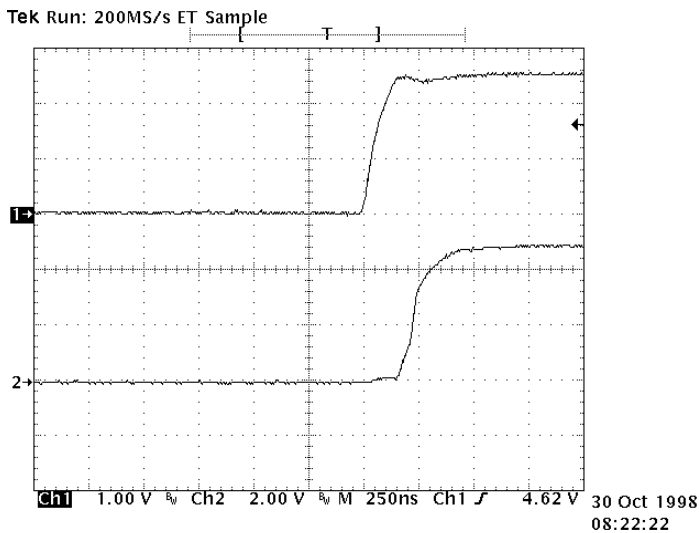

Trace 1: VIN stepping from 3V to 5.5V
Trace 2: DR going high at $V_{TH(HI)}$
 $t_{DH} < 225ns$

Drive Low Delay

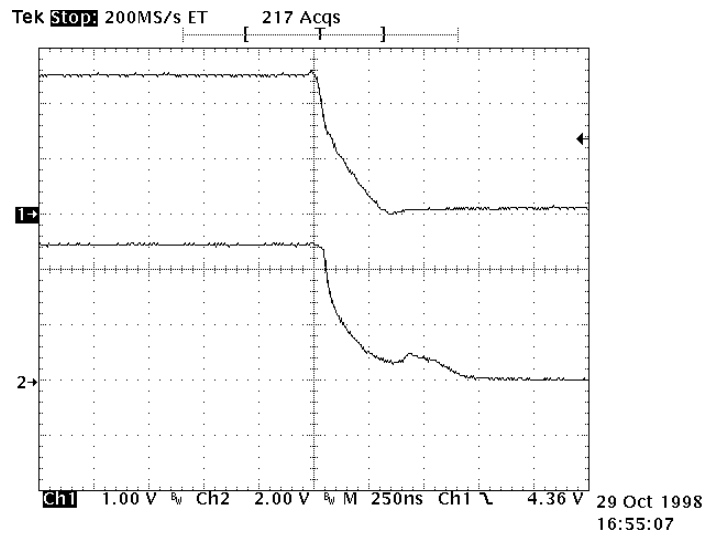

Trace 1: VIN stepping from 5.5V to 3V
Trace 2: DR going low at $V_{TH(LO)}$
 $t_{DL} < 125ns$

VO(MIN) With VIN Rising⁽²⁾

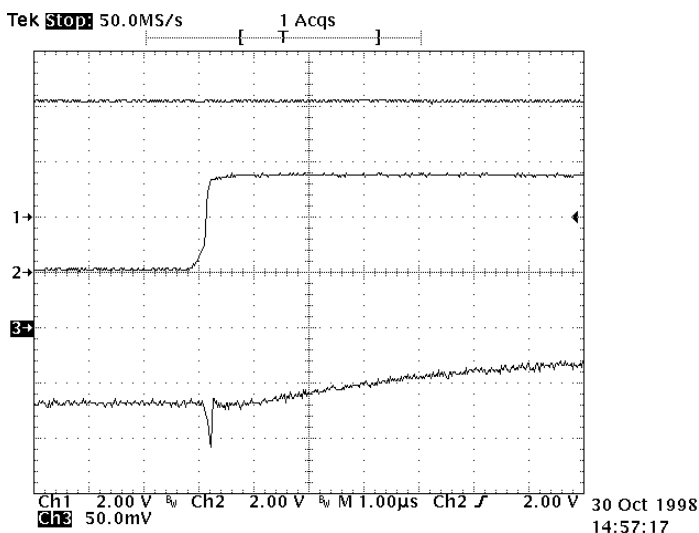

Trace 1: VIN with 3A charging a 1500uF capacitor
Trace 2: DR going high at $V_{TH(HI)}$
Trace 3: VO, offset 3.3V. $VO(MIN) = 3.19V$

VO(MIN) With VIN Falling⁽²⁾

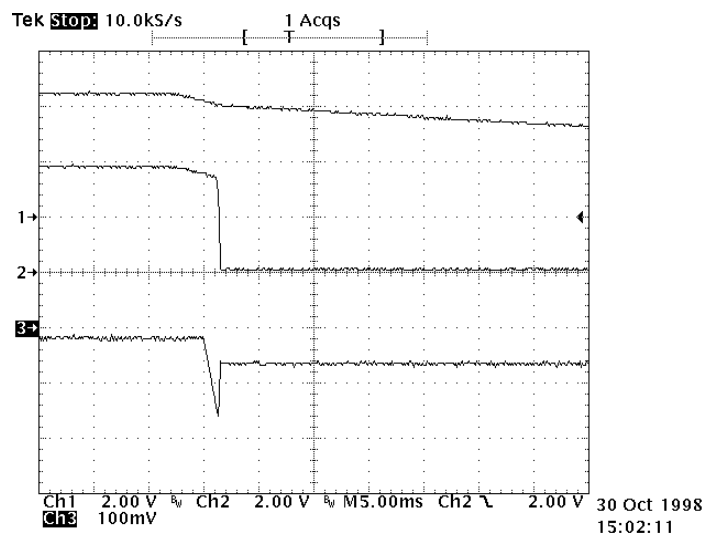

Trace 1: VIN - discharging a 1500uF capacitor
Trace 2: DR going low at $V_{TH(LO)}$
Trace 3: VO, offset 3.3V. $VO(MIN) = 3.14V$

POWER MANAGEMENT

Typical Characteristics (Cont.)⁽¹⁾

Load Transient Response

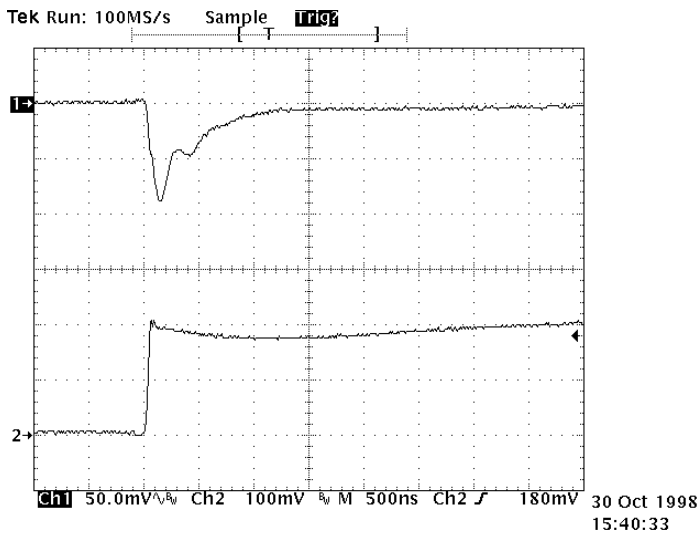

Trace 1: V_O
Trace 2: I_O stepping from 0mA to 200mA

Load Transient Response

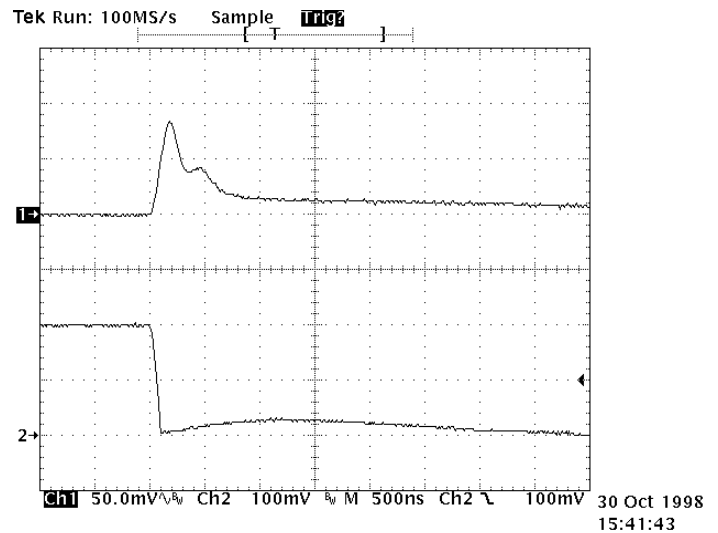

Trace 1: V_O
Trace 2: I_O stepping from 200mA to 0mA

Notes:

- (1) In Application Circuit on page 1.
- (2) I_O = 200mA.

Applications Information

Introduction

The SC1531(A) is intended for applications such as power managed PCI and network interface cards (NICs), where operation from a 3.3V VAUX supply may be required when the 5V supply has been shut down. It provides a very simple, low cost solution that uses very little pcb real estate. During regular operation, 3.3V power for the PCI card is provided by the SC1531(A)'s on-board low dropout regulator, generated from the 5V supply. When the 5V supply is removed and 3.3V VAUX is available, the SC1531(A) connects this supply directly to its output using a tiny SOT-23 external p-channel FET. Connection of pin 3 (VAUX) to the 3.3V supply is optional, and adds active pull-down to the Drive pin.

Component Selection

Output capacitors - Semtech recommends a minimum bulk capacitance of 4.7µF at the output, along with a 0.1µF ceramic decoupling capacitor. Increasing the bulk capacitance will improve the overall transient response. The device is very tolerant of capacitor value and ESR variations, in fact, any combination of capacitors with C ≥ 4.7µF and ESR < 1Ω is sufficient for stability. This

target is easily met using surface mount ceramic or tantalum capacitors.

Input capacitors (5V) - Semtech recommends the use of a 4.7µF ceramic or tantalum capacitor plus a 0.1µF ceramic capacitor at the input. This allows for the device being some distance from any bulk capacitance on the rail. Additionally, input droop due to load transients is reduced, improving load transient response.

Input capacitors (3.3V) - Semtech recommends decoupling this pin (if used) with a 0.1µF ceramic capacitor.

P-channel bypass FET - selection of the external FET is determined by two main requirements:

- 1) the FET has to have a very low gate threshold (typically ~1V) in order to be sufficiently turned on with V_{GS} ≤ 3.3V.
- 2) the FET R_{DS(ON)} must be low enough such that:

$$VAUX - (I_{O(MAX)} \cdot R_{DS(ON)}) \geq VO_{(MIN)}$$

POWER MANAGEMENT
Applications Information (Cont.)

(Remember that at 125°C, $R_{DS(ON)}$ is generally 1.5x the value at 25°C.)

Thermal Considerations

When operating from the 5V supply, the power dissipation in the SC1531(A) is approximately equal to the product of the output current and the input to output voltage differential:

$$P_D \approx (V_{IN} - V_{OUT}) \cdot I_{OUT}$$

The absolute worst-case dissipation is given by:

$$P_{D(MAX)} = (V_{IN(MAX)} - V_{O(MIN)}) \cdot I_{O(MAX)} + V_{AUX(MAX)} \cdot I_{Q(AUX)(MAX)}$$

Note that the $V_{AUX(MAX)} \times I_{Q(AUX)}$ term does not apply if V_{AUX} is not available or not connected.

Inserting $V_{IN} = 5.5V$, $V_O = 3.234V$, $I_O = 200mA$, $V_{AUX} = 3.6V$ and $I_{Q(AUX)} = 2mA$ yields:

$$P_{D(MAX)} = 0.46 W$$

Using this figure, we can calculate the maximum thermal impedance allowable to maintain $T_J \leq 125^\circ C$:

$$R_{TH(J-A)(MAX)} = \frac{(T_{J(MAX)} - T_{A(MAX)})}{P_{D(MAX)}} = \frac{(125 - 70)}{0.46} = 120^\circ C/W$$

$$R_{TH(J-C)(MAX)} = 47^\circ C/W, \text{ therefore } R_{TH(C-A)(MAX)} = 73^\circ C/W$$

This is readily achievable using pcb copper area to aid in conducting the heat away from the device (see Figure 1 on page 10). Heatsinking the bypass FET is not necessary - its power dissipation is given by:

$$P_{D(MAX)} = (I_{O(MAX)})^2 \cdot R_{DS(ON)(MAX)}$$

For $I_O = 200mA$, and $R_{DS(ON)} = 0.6\Omega$, $P_D = 24mW$.

Layout Considerations

While layout for linear devices is generally not as critical as for a switching application, careful attention to detail will ensure reliable operation. See Figure 1 on page 10 for a sample layout.

- 1) Attaching the part to a larger copper footprint will enable better heat transfer from the device, especially on PCBs where there are internal ground and power planes.
- 2) Place the bulk and decoupling capacitors close to the device for optimal transient response.
- 3) If the SENSE lead is being used, route it to the load using a separate trace from the main V_O path. If it is not being used, connect to pin 7 as shown.
- 4) The external bypass FET is shown close to the device for convenience only. Since it is not being switched, longer gate drive traces can be used without problem.

POWER MANAGEMENT
Application Information (Cont.)

Figure 1: Suggested pcb layout based upon Application Circuit on Page 1.

Bill of Materials (Application Circuit Page 1)

Qty.	Reference	Part/Description	Vendor	Notes
3	C1, C3, C5	0.1 μ F ceramic	Various	C1 not required if VAUX not connected
2	C2, C4	4.7 μ F ceramic or tantalum	Various	
1	Q1	MGSF1P02ELT1	Motorola	P-channel, low gate threshold, \leq 400mW (SC1531)
		Si2301DS	Vishay	P-channel, low gate threshold, \leq 200mW (SC1531A)
1	U1	SC1531(A)CS	Semtech	

POWER MANAGEMENT

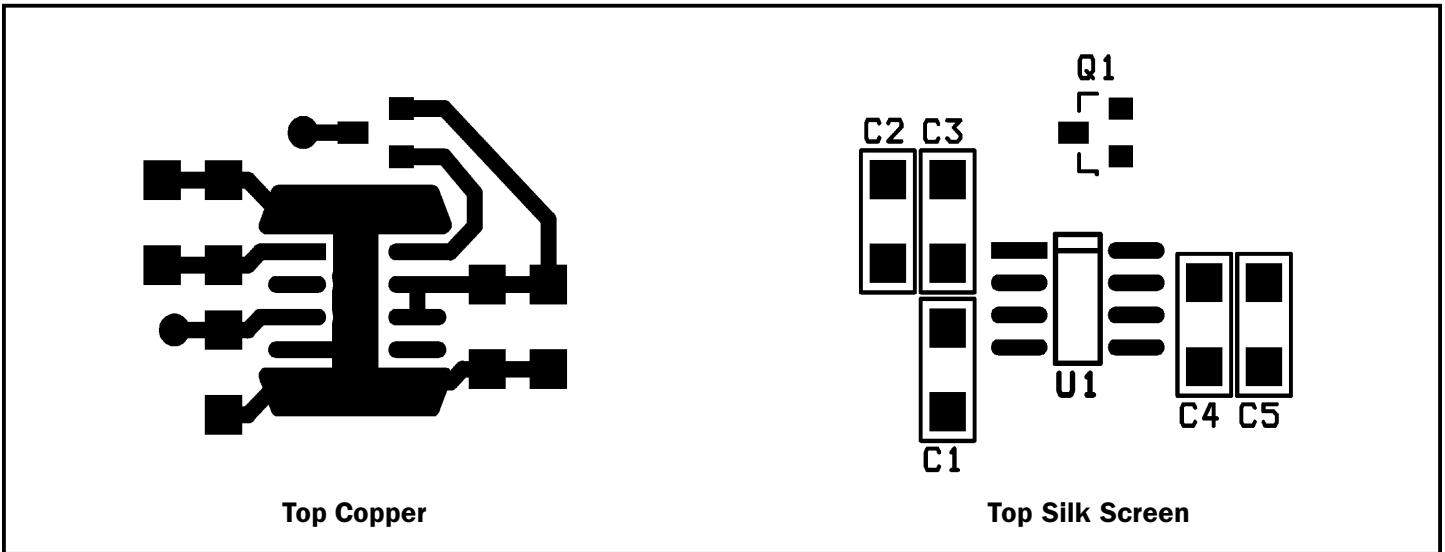
Outline Drawing - SO-8

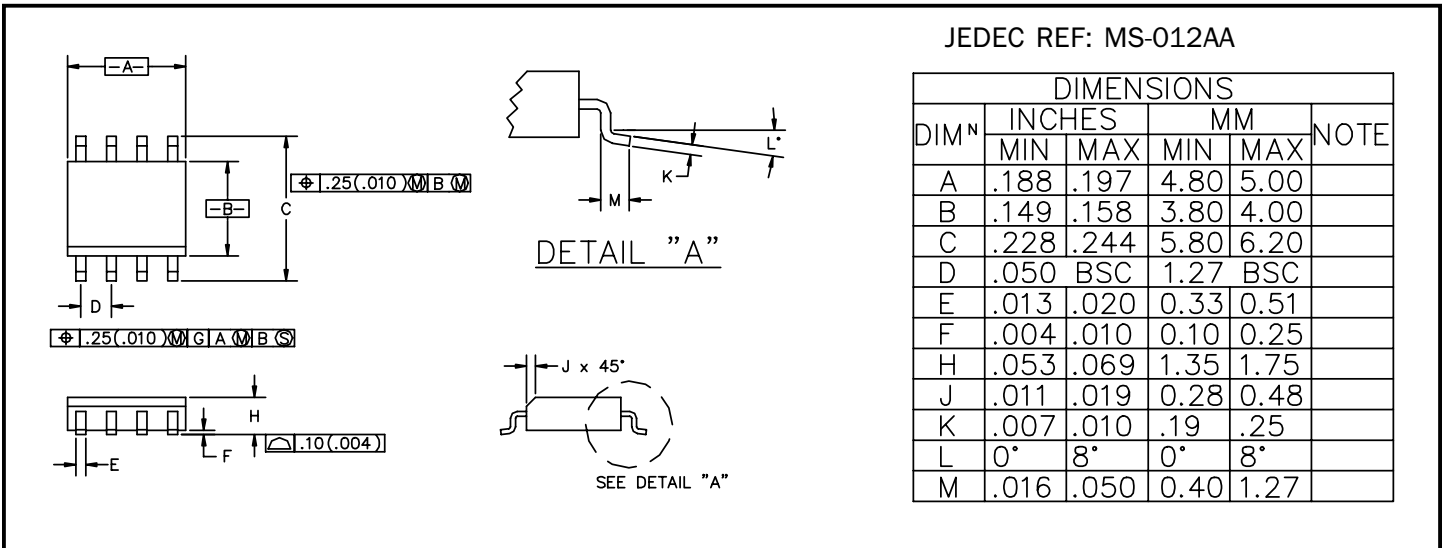

Land Pattern - SO-8

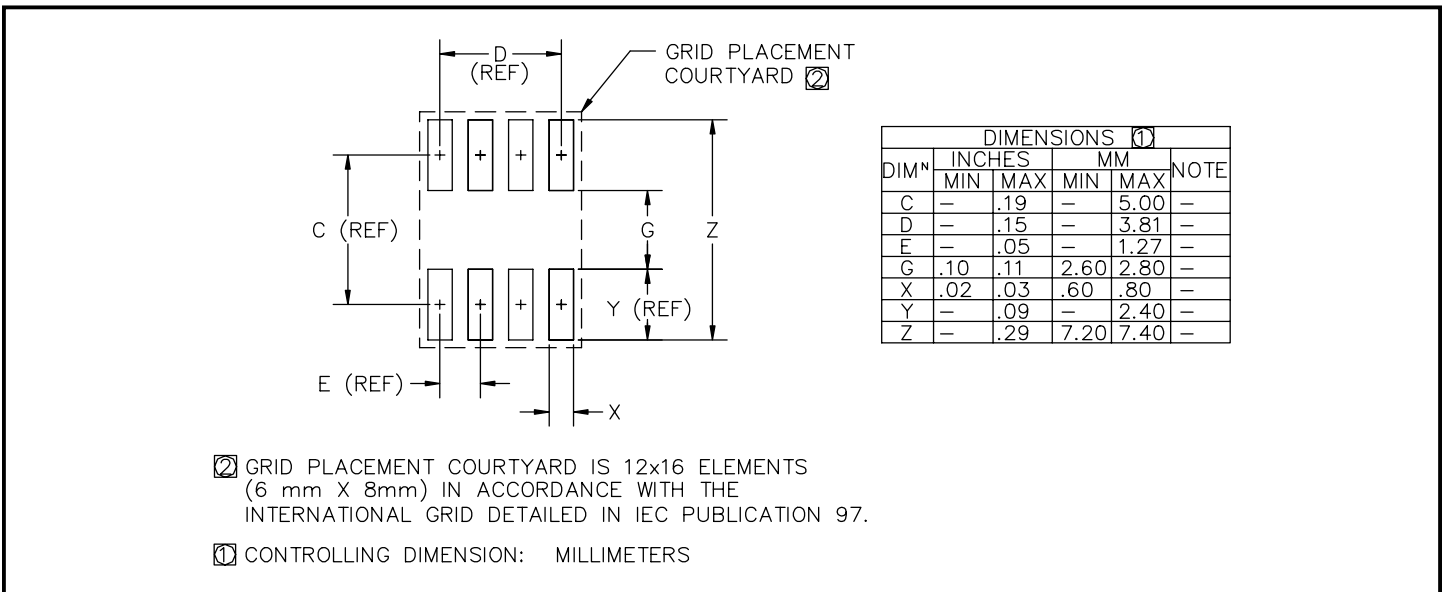

Contact Information

Semtech Corporation
 Power Management Products Division
 652 Mitchell Rd., Newbury Park, CA 91320
 Phone: (805)498-2111 FAX (805)498-3804