

QUARTZ CRYSTAL OSCILLATOR

■ GENERAL DESCRIPTION

The NJU6395 series is a low voltage operation C-MOS quartz crystal oscillator which is possible to 65MHz. It consists of an oscillation amplifier and a 3-state output buffer.

The oscillation amplifier incorporates feed-back resistance and oscillation capacitors (Cg, Cd), therefore it requires no external component except quartz crystal.

The driverbility of the 3-state output buffer is 6mA, thus it can drive C-MOS load.

■ FEATURES

- Low Operating Voltage — 2.2~2.8V
- Recommended Oscillation Frequency — 45 to 65MHz
- High Fan-out — $I_{OL}/I_{OH}=6mA$ @2.5V
- Oscillation Stop and Output Buffer Stand-by Function
- 3-state Output Buffer
- Oscillation Capacitors Cg and Cd on-chip
- Package Outline — Chip/Thin-Chip
- C-MOS Technology

■ PACKAGE OUTLINE



NJU6393C/CT

■ PAD LOCATION

Chip/Thin-Chip

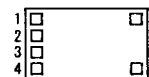

■ COORDINATES

UNIT: μm

No.	PAD	X	Y
1	\overline{CONT}	-428	258
2	XT	-428	86
3	\overline{XT}	-428	-86
4	V _{SS}	-428	-258
5	F _{OUT}	478	-258
8	V _{DD}	478	258

Chip Center : X=0 μm , Y=0 μm
 Chip Size : 1.24x0.8 mm
 Chip Thickness : 400 \pm 30 μm
 Thin-Chip Thickness: 260 \pm 20 μm
 Note1) No. 6 and 7 are no pad.

■ BLOCK DIAGRAM

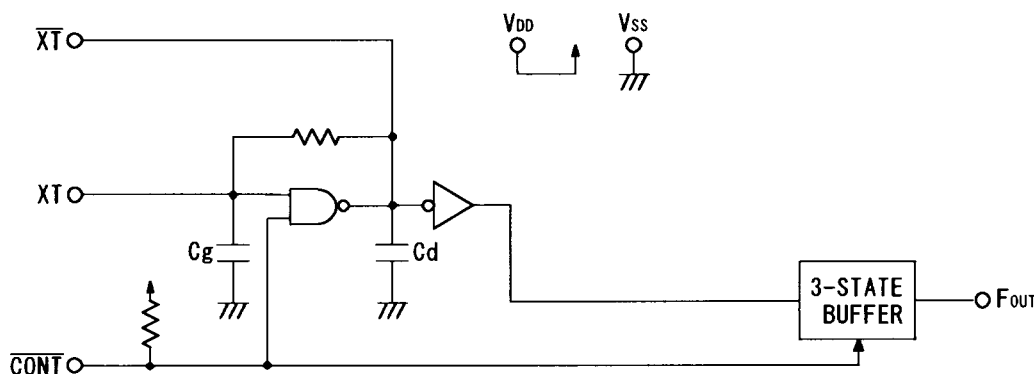

■ TERMINAL DESCRIPTION

No.	SYMBOL	F U N C T I O N	
1	$\overline{\text{CONT}}$	Oscillation and 3-State Output Buffer Control	
		$\overline{\text{CONT}}$	F_{OUT}
		H or Open	Output Frequency f_o
		L	Oscillation Stop and High Impedance Output
2	XT	Quartz Crystal Connecting terminals	
3	$\overline{\text{XT}}$		
4	V_{SS}	GND : $V_{\text{SS}}=0\text{V}$	
5	F_{OUT}	Output Frequency f_o	
8	V_{DD}	$V_{\text{DD}}=2.5\text{V}$	

■ ABSOLUTE MAXIMUM RATINGS

(Ta=25°C)

P A R A M E T E R	SYMBOL	R A T I N G S	UNIT
Supply Voltage	V_{DD}	-0.5 ~ +7.0	V
Input Voltage	V_{IN}	$V_{\text{SS}}-0.5 \sim V_{\text{DD}}+0.5$	V
Output Voltage	V_o	-0.5 ~ $V_{\text{DD}}+0.5$	V
Input Current	I_{IN}	±10	mA
Output Current	I_o	±25	mA
Operating Temperature Range	Topr	-40 ~ + 85	°C
Storage Temperature Range	Tstg	-55 ~ +125	°C

Note2) Decoupling capacitor should be connected between V_{DD} and V_{SS} due to the stabilized operation for the circuit.

■ ELECTRICAL CHARACTERISTICS

 (V_{DD}=3.0V, Ta=25°C)

PARAMETER	SYMBOL	CONDITIONS	MIN	TYP	MAX	UNIT
Operating Voltage	V _{DD}		2.2		2.8	V
Operating Current	I _{DD1}	f _{OSC} =48MHz, No Load		8	15	mA
Stand-by Current	I _{st}	CONT=XT=V _{SS} , No load Note3			1	uA
Input Voltage	V _{IH}		2.0		2.5	V
	V _{IL}		0		0.5	
Output Current	I _{OH}	V _{OH} =2.25V	6			mA
	I _{OL}	V _{OL} =0.25V	6			
Input Current	I _{IN}	CONT=V _{SS}	62	125	250	uA
3-state Off-leakage Current	I _{oz}	CONT=V _{SS} , F _{OUT} =V _{DD} or V _{SS}			±0.1	uA
Internal Capacitor	C _s /C _d	f _{OSC} =48MHz		12/14		pF
Maximum Oscillation Frequency	F _{MAX}		65			MHz
Output Signal Symmetry	SYM	C _L =15pF, @1/2·V _{DD}	45	50	55	%
Output Signal Rise Time	t _r	C _L =15pF, 10%~90%		2.6	6	ns
Output Signal Fall Time	t _f	C _L =15pF, 90%~10%		2.6	6	
Output Disable Time	T _{PLZ}	C _L =15pF, R _{UP} =10kΩ			200	ns
Output Enable Time	T _{PZL}	C _L =15pF, R _{UP} =10kΩ			200	

Note3) Excluding input current on CONT terminal.

MEASUREMENT CIRCUITS

(1) Output Signal Symmetry ($C_L=15pF$)

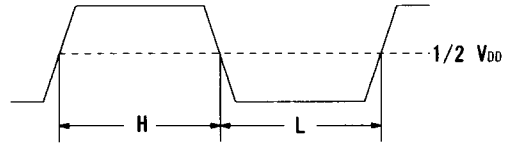
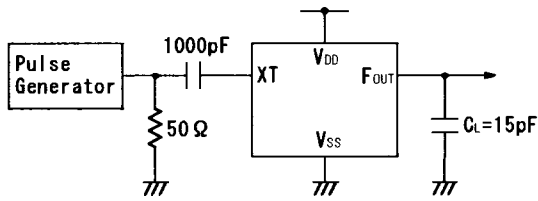

(2) Output Signal Rise/Fall Time ($C_L=15pF$)

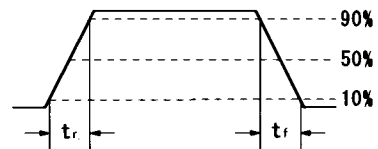
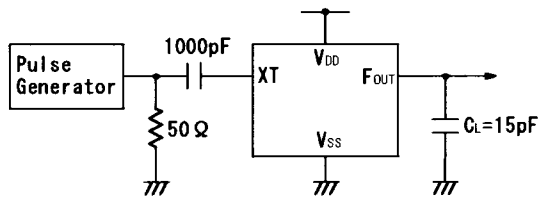

(3) Output Disable/Enable Time ($C_L=15pF, R_{up}=10k\Omega$)

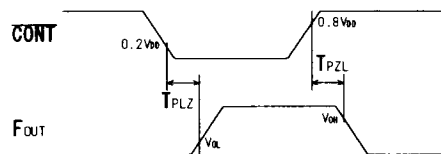
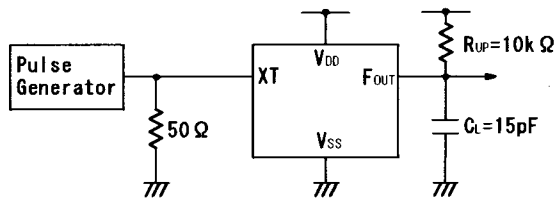

[CAUTION]

The specifications on this data book are only given for information, without any guarantee as regards either mistakes or omissions. The application circuits in this data book are described only to show representative usages of the product and not intended for the guarantee or permission of any right including the industrial rights.