

Cascadable Silicon Bipolar MMIC Amplifier

Technical Data

MSA-1120

Features

- **High Dynamic Range**
Cascadable 50 Ω or 75 Ω
Gain Block
- **3 dB Bandwidth:**
50 MHz to 1.6 GHz
- **17.5 dBm Typical P_{1 dB} at
0.5 GHz**
- **12 dB Typical 50 Ω Gain at
0.5 GHz**
- **3.5 dB Typical Noise Figure
at 0.5 GHz**
- **Hermetic Metal/Beryllia
Microstrip Package**

Description

The MSA-1120 is a high performance silicon bipolar Monolithic Microwave Integrated Circuit (MMIC) housed in a hermetic BeO

disk package for good thermal characteristics. This MMIC is designed for high dynamic range in either 50 or 75 Ω systems by combining low noise figure with high IP₃. Typical applications include narrow and broadband linear amplifiers in industrial and military systems.

The MSA-series is fabricated using HP's 10 GHz f_T, 25 GHz f_{MAX} silicon bipolar MMIC process which uses nitride self-alignment, ion implantation, and gold metallization to achieve excellent performance, uniformity and reliability. The use of an external bias resistor for temperature and current stability also allows bias flexibility.

200 mil BeO Package

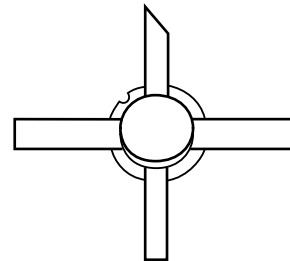

Typical Biasing Configuration

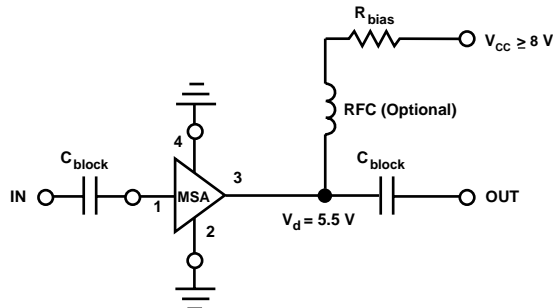

MSA-1120 Absolute Maximum Ratings

Parameter	Absolute Maximum ^[1]
Device Current	100 mA
Power Dissipation ^[2,3]	650 mW
RF Input Power	+13 dBm
Junction Temperature	200°C
Storage Temperature	-65 to 200°C

Thermal Resistance^[2,4]:

$$\theta_{jc} = 60^{\circ}\text{C/W}$$

Notes:

1. Permanent damage may occur if any of these limits are exceeded.
2. $T_{\text{CASE}} = 25^{\circ}\text{C}$.
3. Derate at $16.7 \text{ mW}/^{\circ}\text{C}$ for $T_{\text{C}} > 161^{\circ}\text{C}$.
4. The small spot size of this technique results in a higher, though more accurate determination of θ_{jc} than do alternate methods. See MEASUREMENTS section "Thermal Resistance" for more information.

Electrical Specifications^[1], $T_{\text{A}} = 25^{\circ}\text{C}$

Symbol	Parameters and Test Conditions: $I_{\text{d}} = 60 \text{ mA}$, $Z_{\text{o}} = 50 \Omega$	Units	Min.	Typ.	Max.
G_{P}	Power Gain ($ S_{21} ^2$) $f = 0.1 \text{ GHz}$	dB	11.5	12.5	13.5
ΔG_{P}	Gain Flatness $f = 0.1 \text{ to } 1.0 \text{ GHz}$	dB		± 0.7	± 1.0
$f_{3 \text{ dB}}$	3 dB Bandwidth ^[2]	GHz		1.6	
VSWR	Input VSWR $f = 0.1 \text{ to } 1.5 \text{ GHz}$			1.7:1	
	Output VSWR $f = 0.1 \text{ to } 1.5 \text{ GHz}$			1.9:1	
NF	50 Ω Noise Figure $f = 0.5 \text{ GHz}$	dB		3.5	4.5
$P_{1 \text{ dB}}$	Output Power at 1 dB Gain Compression $f = 0.5 \text{ GHz}$	dBm	16.0	17.5	
IP_3	Third Order Intercept Point $f = 0.5 \text{ GHz}$	dBm		30.0	
t_{D}	Group Delay $f = 0.5 \text{ GHz}$	psec		200	
V_{d}	Device Voltage	V	4.5	5.5	6.5
dV/dT	Device Voltage Temperature Coefficient	mV/ $^{\circ}\text{C}$		-8.0	

Notes:

1. The recommended operating current range for this device is 40 to 75 mA. Typical performance as a function of current is on the following page.
2. Referenced from 50 MHz gain (G_{P}).

MSA-1120 Typical Scattering Parameters ($Z_0 = 50 \Omega$, $T_A = 25^\circ\text{C}$, $I_d = 60 \text{ mA}$)

Freq. GHz	S_{11}		S_{21}			S_{12}			S_{22}		k
	Mag	Ang	dB	Mag	Ang	dB	Mag	Ang	Mag	Ang	
.0005	.78	-21	19.6	9.53	168	-25.1	.057	50	.79	-21	0.51
.005	.19	-72	13.8	4.91	165	-16.8	.144	11	.19	-72	0.98
.025	.05	-56	12.9	4.44	174	-16.5	.149	3	.06	-75	1.08
.050	.04	-52	12.5	4.23	174	-16.1	.156	2	.04	-79	1.08
.100	.04	-56	12.5	4.22	172	-16.2	.155	1	.04	-78	1.09
.200	.05	-72	12.4	4.19	165	-16.1	.157	1	.06	-91	1.08
.300	.07	-84	12.4	4.15	158	-16.0	.159	2	.09	-101	1.07
.400	.09	-96	12.3	4.10	151	-15.9	.161	2	.11	-109	1.06
.500	.10	-105	12.1	4.04	144	-15.8	.163	3	.13	-117	1.05
.600	.12	-113	12.0	3.98	137	-15.6	.166	3	.16	-124	1.04
.700	.14	-120	11.8	3.89	131	-15.4	.169	2	.18	-130	1.03
.800	.15	-127	11.6	3.80	124	-15.2	.173	2	.20	-136	1.01
.900	.17	-134	11.4	3.71	118	-15.0	.178	1	.22	-142	1.00
1.000	.19	-140	11.1	3.60	112	-14.8	.181	2	.24	-148	0.99
1.500	.25	-167	9.8	3.10	83	-14.0	.200	-3	.31	-174	0.95
2.000	.31	171	8.4	2.64	58	-13.3	.216	-10	.35	163	0.95
2.500	.35	157	7.3	2.31	39	-12.8	.228	-16	.36	148	0.96
3.000	.40	140	6.1	2.02	19	-12.5	.236	-23	.36	134	0.99

A model for this device is available in the DEVICE MODELS section.

Typical Performance, $T_A = 25^\circ\text{C}$, $Z_0 = 50 \Omega$

(unless otherwise noted)

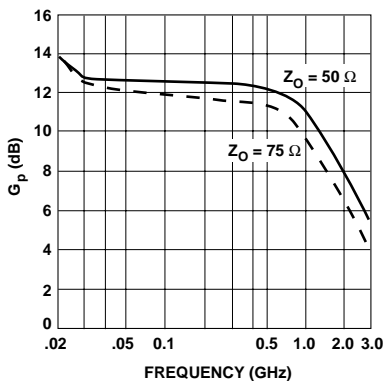

Figure 1. Typical Power Gain vs. Frequency, $I_d = 60 \text{ mA}$.

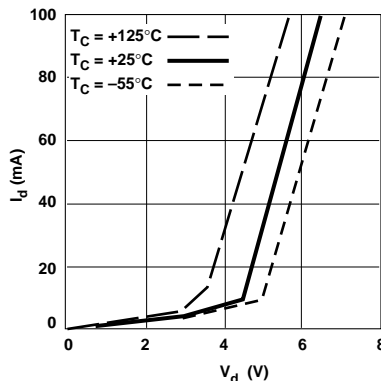

Figure 2. Device Current vs. Voltage.

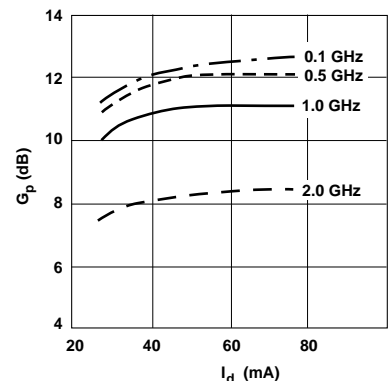

Figure 3. Power Gain vs. Current.

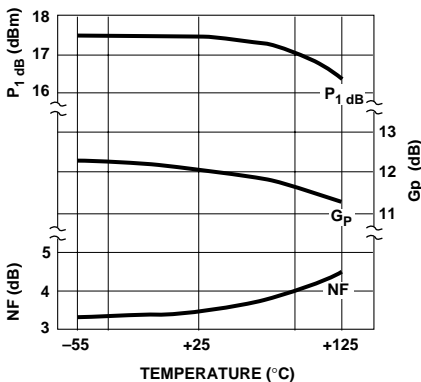

Figure 4. Output Power at 1 dB Gain Compression, Noise Figure and Power Gain vs. Case Temperature, $f = 0.5 \text{ GHz}$, $I_d = 60 \text{ mA}$.

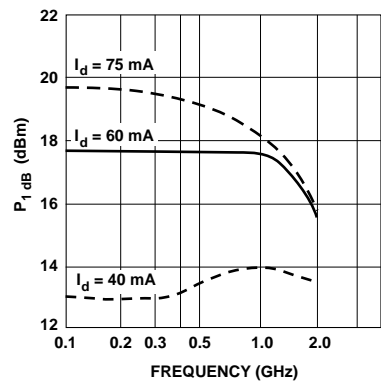

Figure 5. Output Power at 1 dB Gain Compression vs. Frequency.

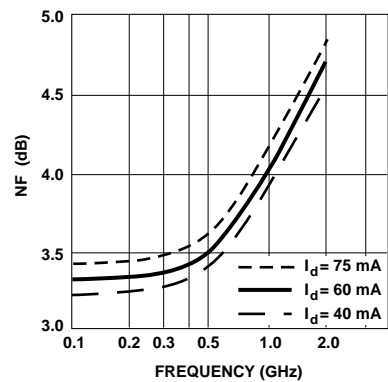
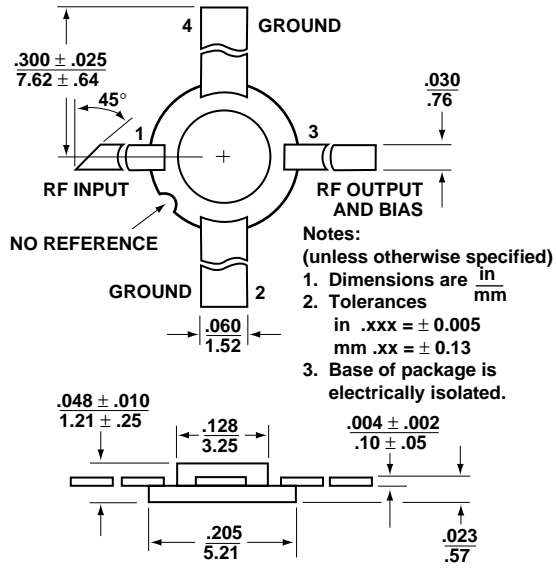

Figure 6. Noise Figure vs. Frequency.

200 mil BeO Package Dimensions



Package marking code is "A11"