



MC13280AY MC13281A/B

Advance Information 80/100 MHz Video Processor

The MC13280AY and MC13281A/B are three channel wideband amplifiers designed for use as a video pre-amplifier in high resolution RGB color monitors.

Features:

- 4.0 Vpp Output Swing
- 3.5 ns Rise/Fall Time, 100 MHz Bandwidth (MC13281A/B)
- 4.3 ns Rise/Fall Time, 80 MHz Bandwidth (MC13280AY)
- Subcontrast Controls for Each Channel
- Main Contrast Control
- Blanking and Clamping Inputs
- Packages: NDIP-24 and NDIP-20
- A Single PC Board Pattern Can Accept the MC13281A and the MC13282A (Video Amplifier with OSD)

80/100 MHz VIDEO PROCESSOR

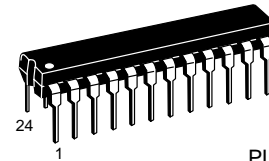

P SUFFIX
PLASTIC PACKAGE
CASE 724

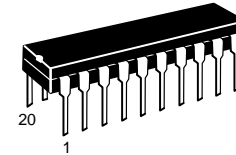

P SUFFIX
PLASTIC PACKAGE
CASE 738

ORDERING INFORMATION

Device	Operating Temperature Range	Package
MC13280AYP	$T_A = 0^\circ$ to $+70^\circ\text{C}$	Plastic DIP
MC13281AP		Plastic DIP
MC13281BP		Plastic DIP

ABSOLUTE MAXIMUM RATINGS

Rating	Pin	Value	Unit
Power Supply Voltage	V_{CC} Video V_{CC}	-0.5, 10 -0.5, 10	Vdc
Voltage at Video Amplifier Inputs	2, 4, 6	-0.5, +5.0	Vdc
Collector-Emitter Current (Three Channels)	Video V_{CC}	120	mA
Storage Temperature	-	-65 to +150	$^\circ\text{C}$
Junction Temperature	-	150	$^\circ\text{C}$

NOTES: 1. Devices should not be operated at these limits. Refer to "Recommended Operating Conditions" section for actual device operation.

2. ESD data available upon request.

PIN CONNECTIONS

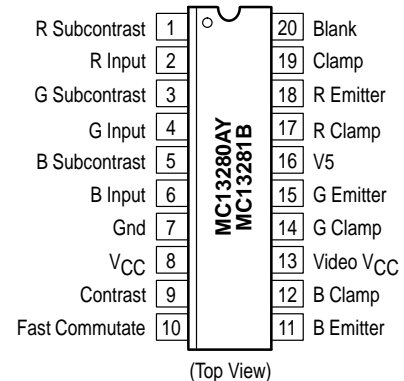
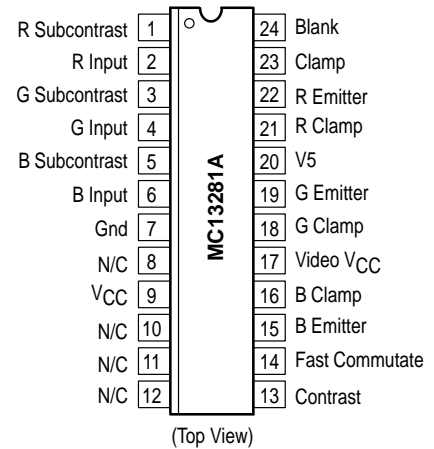

MC13280AY MC13281A/B

RECOMMENDED OPERATING CONDITIONS

Characteristic	Pin	Min	Typ	Max	Unit
Power Supply Voltage	V _{CC} , Video V _{CC}	7.6	8.0	8.4	Vdc
Contrast Control	Contrast	0	–	5.0	Vdc
Subcontrast Control	1, 3, 5	0	–	5.0	Vdc
Blanking Input Signal Amplitude	Blank	0	–	5.0	V
Clamping Input Signal Amplitude	Clamp	0	–	5.0	V
Video Signal Amplitude (with 75 Ω Termination)	2, 4, 6	–	0.7	1.0	Vpp
Collector–Emitter Current (Total for Three Channels)	Video V _{CC}	0	–	50	mA
Clamp Pulse Width	Clamp	500	–	–	ns
Operating Ambient Temperature	–	0	–	70	°C

ELECTRICAL CHARACTERISTICS (Refer to Test Circuit Figure 1, T_A = 25°C, V_{CC} = 8.0 Vdc.)

Characteristic	Condition	Pin	Min	Typ	Max	Unit
Input Impedance	–	2, 4, 6	100	–	–	kΩ
Internal DC Bias Voltage	–	–	–	2.4	–	Vdc
Output Signal Amplitude	V ₂ , V ₄ , V ₆ = 0.7 Vpp V ₁ , V ₃ , V ₅ = 5.0 V Contrast = 5.0 V	R, G, B Emitters	3.6	4.0	–	Vpp
Voltage Gain	–	–	–	5.6	–	V/V
Contrast Control	Contrast = 5.0 to 0 V V ₁ , V ₃ , V ₅ = 5.0 V	Contrast	–	–26	–	dB
Subcontrast Control	V ₁ , V ₃ , V ₅ = 5.0 to 0 V Contrast = 5.0 V	1, 3, 5	–	–26	–	dB
Emitter DC Level	–	–	1.0	1.2	1.4	Vdc
Blanking Input Threshold	–	Blank	–	1.25	–	V
Clamping Input Threshold	–	Clamp	–	3.75	–	V
Video Rise Time	V ₂ , V ₄ , V ₆ = 0.7 Vpp V _{out} = 4.0 Vpp R _L > 300 Ω, C _L < 5.0 pF	R, G, B Emitters	–	4.3 3.5	–	ns
Video Fall Time	V ₂ , V ₄ , V ₆ = 0.7 Vpp V _{out} = 4.0 Vpp R _L > 300 Ω, C _L < 5.0 pF	R, G, B Emitters	–	4.3 3.5	–	ns
Video Bandwidth	V ₂ , V ₄ , V ₆ = 0.7 Vpp V ₁ , V ₃ , V ₅ , Contrast = 5.0 V R _L > 300 Ω, C _L < 5.0 pF	R, G, B Emitters	–	80 100	–	MHz
Power Supply Current	V _{CC} , Video V _{CC} = 8.0 V	–	–	70	–	mA

NOTE: It is recommended to use a double sided PCB layout for high frequency measurement (e.g., rise/fall time, bandwidth).

MC13280AY MC13281A/B

Figure 1. Internal Block Diagram

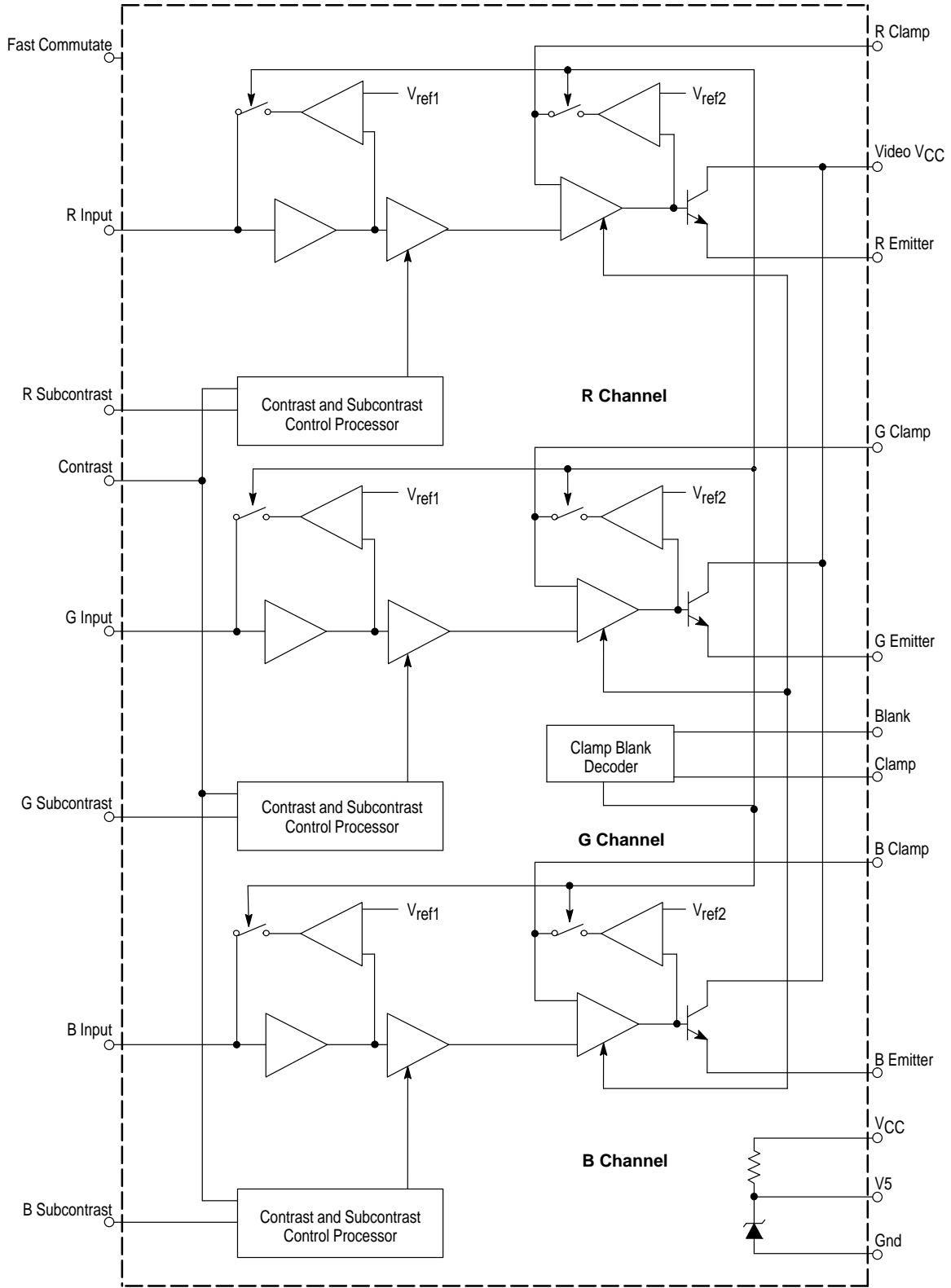

This device contains 272 active transistors.

MC13280AY MC13281A/B

PIN FUNCTION DESCRIPTION

MC13280AY MC13281B Pin	MC13281A Pin	Name	Equivalent Internal Circuit	Description
1 3 5	1 3 5	R Subcontrast Control G Subcontrast Control B Subcontrast Control		These pins provides a maximum of 26 dB attenuation to vary the gain of each video amplifier separately. Input voltage is from 0 to 5.0 V. Increasing the voltage will increase the contrast level.
2 4 6	2 4 6	R Input G Input B Input		The input coupling capacitor is used for input clamping storage. The maximum source impedance is 100 Ω. Input polarity of the video signal is positive. Nominal 0.7 Vpp input signal is recommended (maximum 1.0 Vpp).
7	7	Ground		Ground pin. Connect to a clean, solid ground.
N/A	8 10 11 12	N/C N/C N/C N/C		Connected to ground.
8	9	VCC		Connect to 8.0 Vdc supply, ±5%. Decoupling is required at this pin.
9	13	Contrast		Overall Contrast Control for the three channels. The input range is 0 V to 5.0 V. An increase of voltage increases the contrast.
10	14	Fast Commutate		Must be connected to ground.
11 15 18	15 19 22	B Emitter Output G Emitter Output R Emitter Output		The video outputs are configured as emitter-followers with a driving capability of about 15 mA each. The dc voltage at these three emitters is set to 1.2 V (black level). The dc current through the output stage is determined by the emitter resistors (typically 330 Ω).

MC13280AY MC13281A/B

PIN FUNCTION DESCRIPTION (continued)

MC13280AY MC13281B Pin	MC13281A Pin	Name	Equivalent Internal Circuit	Description
12	16	B Clamp Capacitor		<p>A 100 nF capacitor is connected to each of these pins.</p> <p>The capacitor is used for video output dc restoration.</p>
14	18	G Clamp Capacitor		
17	21	R Clamp Capacitor		
13	17	Video V _{CC}		<p>Connect to 8.0 V dc supply, ±5%. The V_{CC} is for the video output stage. It is internally connected to the collectors of the output transistors.</p>
16	20	5.0 V _{ref} (V5)		<p>5.0 V regulator. Minimum 10 µF capacitor is required for noise filtering and compensation. It can source up to 20 mA but not sink current. Output impedance is ≈ 10 Ω. Recommended for use as a voltage reference only.</p>
19	23	Clamp		<p>This pin is used for video clamping.</p> <p>The threshold clamping level is 3.75 V.</p>
20	24	Blank		<p>This pin is used for video blanking.</p> <p>The threshold blanking level is 1.25 V.</p>

MC13280AY MC13281A/B

FUNCTIONAL DESCRIPTION

The MC13280AY and MC13281A/B are composed of three video amplifiers, clamping and blanking circuitry with contrast and subcontrast controls. Each video amplifier is designed to have a -3.0 dB bandwidth of 100 MHz (MC13281, 80 MHz for the MC13280) with a gain of up to about 5.6 V/V, or 15 dB.

Video Input

The video input stages are high impedance and designed to accept a maximum signal of 1.0 V_{pp} with 75 Ω termination (typically) provided externally. During the clamping period, a current is provided to the input capacitor by the clamping circuit which brings the input to a proper dc level (nominal 2.0 V). The blanking and clamping signals are to be provided externally, with their thresholds at 1.25 V and 3.75 V, respectively.

Video Output

The video output stages are configured as emitter-followers, with a driving capability of about 15 mA for each channel. The dc voltage at these three emitters is set to 1.2 V (black level). The dc current through each output stage is determined by the emitter resistor (typically 330 Ω).

Contrast Control

The contrast control varies the gain of three video amplifiers from a minimum of 0.3 V/V to a maximum of 5.6 V/V when all subcontrast levels are set to 5.0 V.

Subcontrast Control

Each subcontrast control provides a maximum of 26 dB attenuation on each video amplifier separately.

Clamp Pulse Input

The clamping pulse is provided externally, and the pulse width must be no less than 500 ns.

Blank Pulse Input

The blanking pulse is used to blank the video signal during the horizontal sync period, or used as a control pin for video mute function.

Fast Commutate

This pin should be connected to ground.

Power Supplies

V_{CC} and Video V_{CC} supplies are to be 8.0 V \pm 5%.

Figure 2. Test Circuit

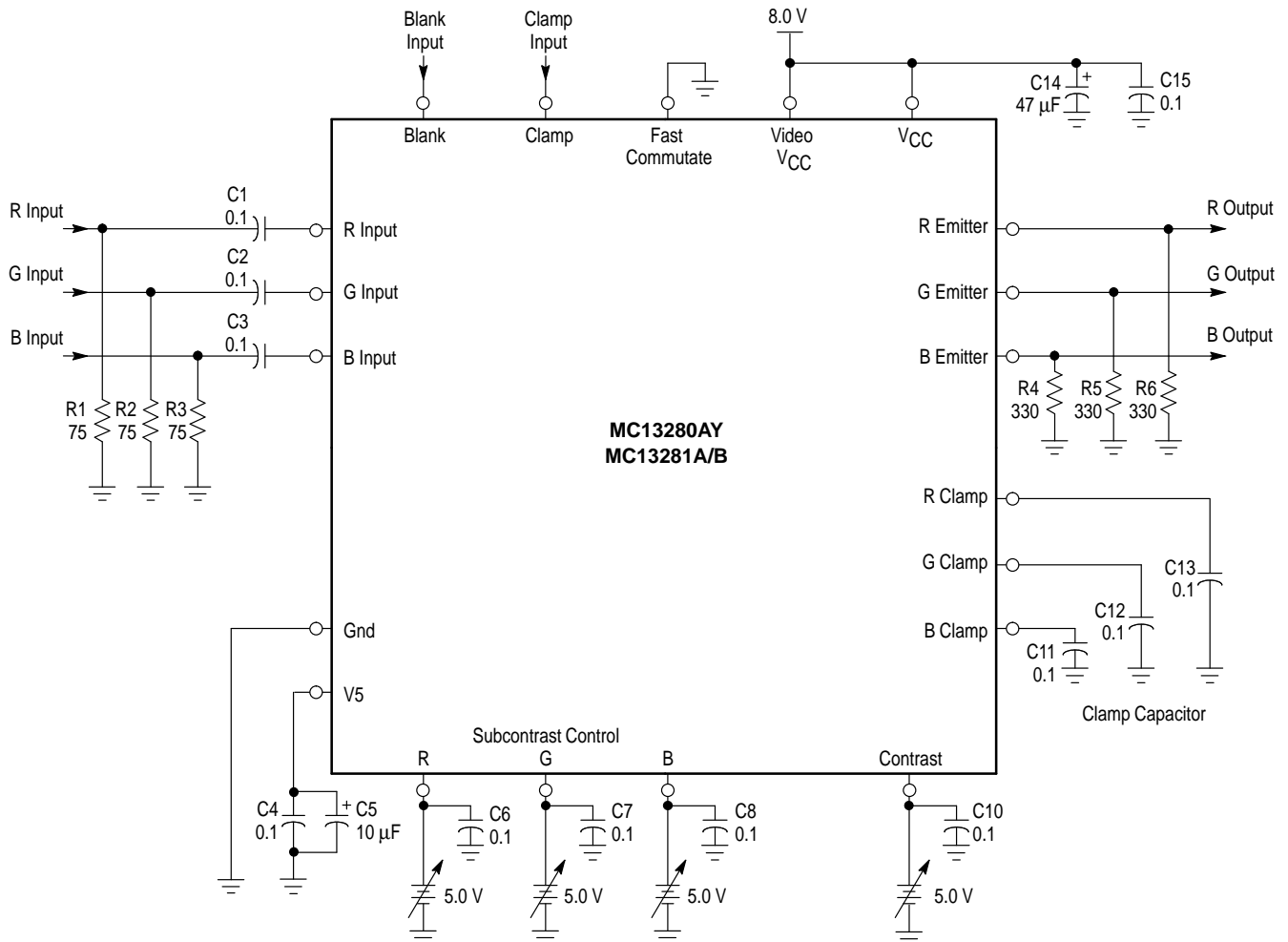

MC13280AY MC13281A/B

APPLICATION INFORMATION

PCB Layout

Care should be taken in the PCB layout to minimize the noise effects. The most sensitive pins are V_{CC} , Video V_{CC} , V5 and Clamp. It is strongly recommended to make a ground plane and connect V_{CC} /Video V_{CC} and ground traces, to the power supply directly. Separate power supply traces should be used for V_{CC} and Video V_{CC} and decoupling capacitors should be connected as close as possible to the device. Multi-layer ceramic and tantalum capacitors are recommended. V5 is designed as a 5.0 V voltage reference for contrast, and RGB subcontrast controls, so the same precautions for V_{CC} should also be applied at this pin. The Clamp capacitors should be connected to ground close to IC's ground pin, or power supply ground. The copper trace of video signal inputs and outputs should be as short as possible and separated by ground traces to avoid any RGB cross-interference. A double sided PCB should be used to optimize the device's performance.

RGB Input and Output

The RGB output stages are designed as emitter-followers to drive the CRT driver circuitry directly. The emitter resistors used are 330 Ω (typically) and the driving current is 15 mA maximum for each channel. The loading impedance connected to the output stages should be greater than 330 Ω and less than 5.0 pF for optimum performance (e.g., rise/fall time, bandwidth, etc.). Decreasing the resistive load will

reduce the rise/fall time by increasing the driving current, but the output stage may be damaged due to increasing power dissipation at the same time. The frequency response is affected by the loading capacitance. The typical value is 3.0 to 5.0 pF. Figure 3 shows a typical interface with a video output driver. For high resolution color monitor application, it is recommended to use coaxial cable or shielded cable for input signal connections.

Clamp and Blank Input

The clamp input is normally (except for Sync-on-Green) connected to a positive horizontal sync pulse and has a threshold level of 3.75 V. It is used as a timing reference for the dc restoration process, so it cannot be an open circuit. If Sync-on-Green timing mode is used, the clamping pulse should be located at the horizontal back porch period instead of horizontal sync. Otherwise, the black level will be clamped at the wrong dc level.

The blank input is used as a video mute, or horizontal blanking control pin, and is normally connected to a blanking pulse generated from the flyback or MCU. The threshold level is 1.25 V. The blanking pulse width should be equal to the flyback retrace period to make sure that the video signal is blanked properly during retrace. It is necessary to limit the amplitude and avoid any negative undershoot if the flyback pulse is used. The blanking input pin cannot accept a negative voltage. This pin should be grounded if it is not used.

MC13280AY MC13281A/B

Figure 3. Interfacing with Video Output Drivers

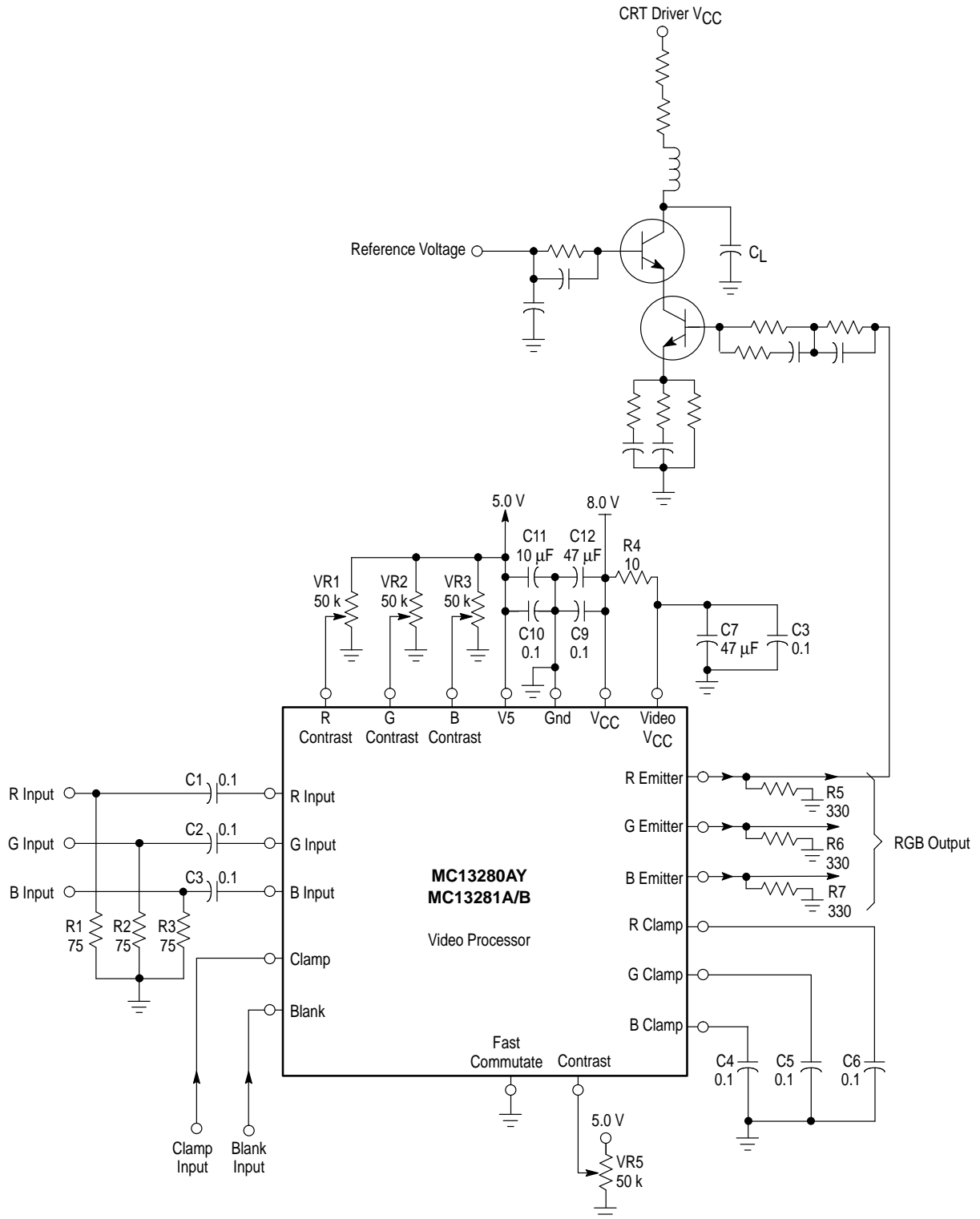

MC13280AY MC13281A/B

Figure 4. RGB In/Out Linearity

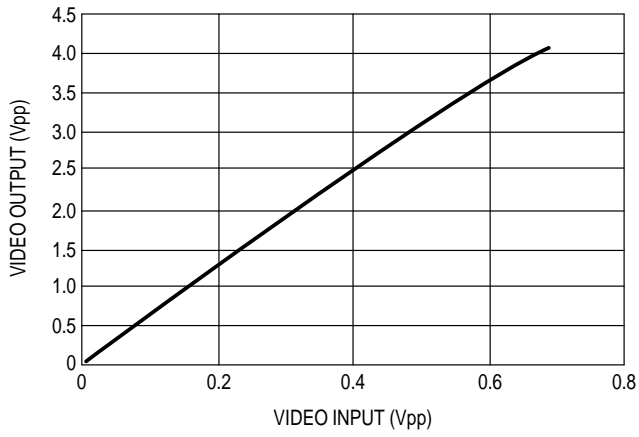

Figure 5. Contrast Control

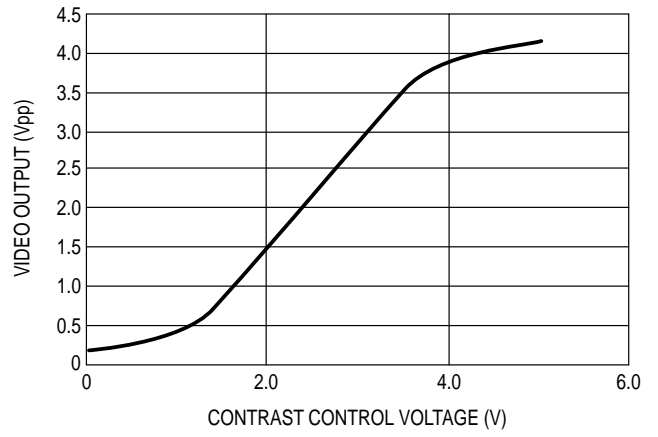

Figure 6. Subcontrast Control

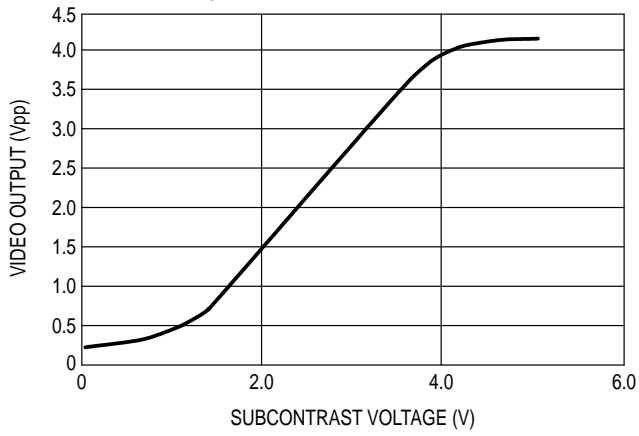
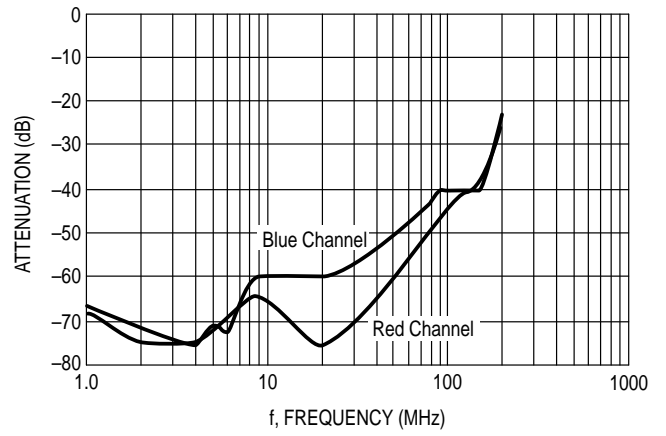
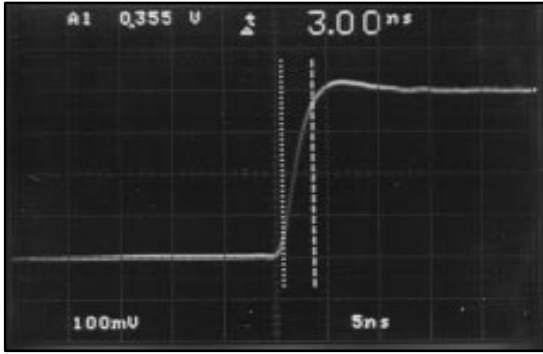

Figure 7. Crosstalk From Green to Red and Blue Channels



MC13280AY MC13281A/B

Figure 8. Rise Time for MC13281B



100 mV/DIV
5.0 ns/DIV
10x PROBE

Figure 9. Fall Time for MC13281B

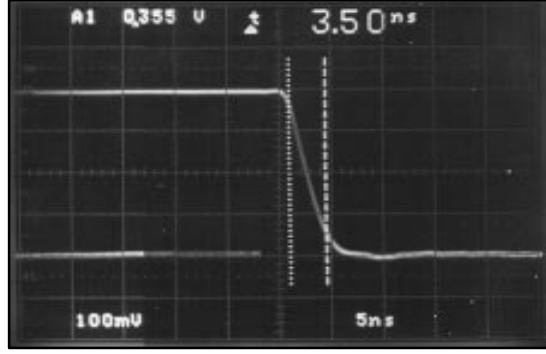

100 mV/DIV
5.0 ns/DIV
10x PROBE

NOTE: Recommend to use a double sided PCB without any socket for rise/fall time measurements, using an input pulse with 1.5 ns rise/fall time and an active probe with 1.7 pF capacitance loading.

Figure 10. Single Sided PCB Layout (Component Side) for MC13280AY, MC13281B

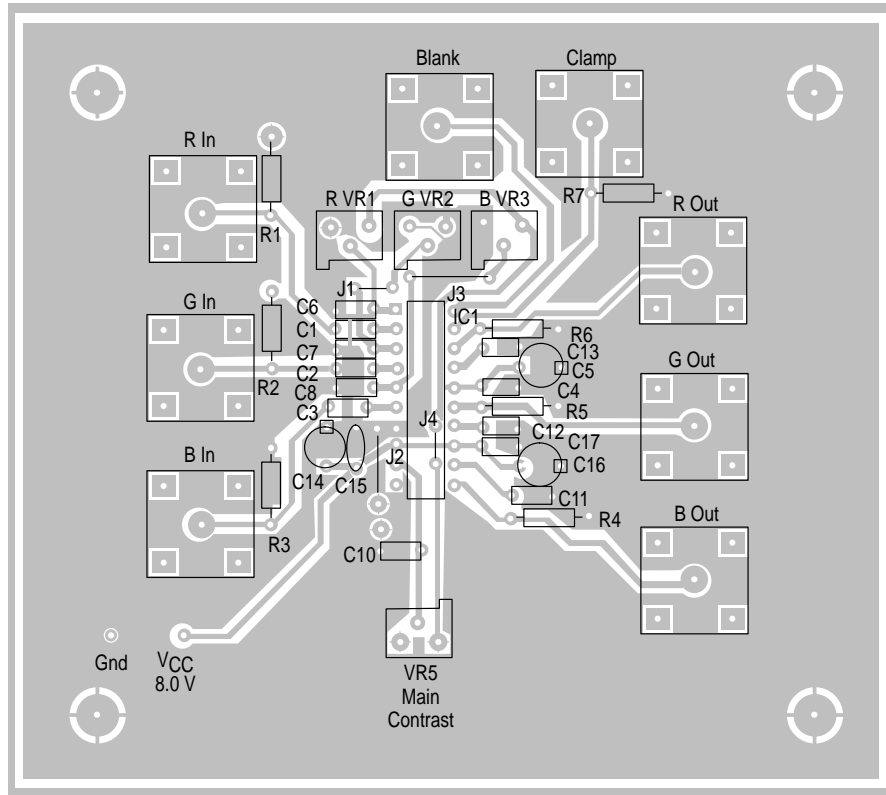

NOTE: J = Jumper

MC13280AY MC13281A/B

OUTLINE DIMENSIONS

P SUFFIX PLASTIC PACKAGE CASE 724-03 ISSUE D

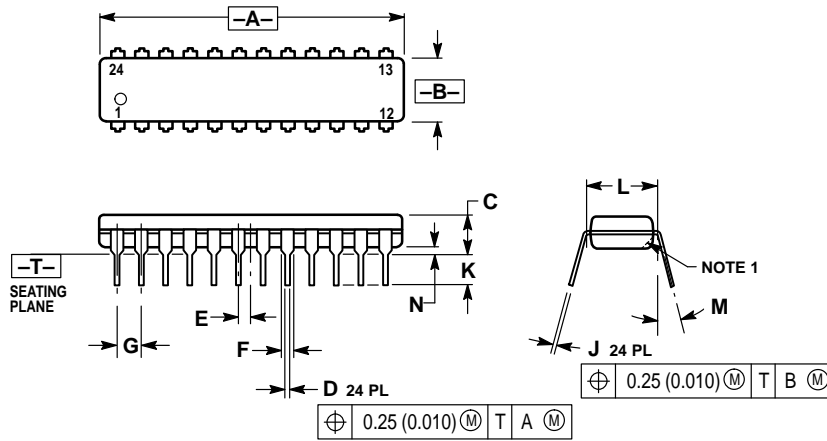

NOTES:

1. CHAMFERED CONTOUR OPTIONAL.
2. DIMENSION L TO CENTER OF LEADS WHEN FORMED PARALLEL.
3. DIMENSIONING AND TOLERANCING PER ANSI Y14.5M, 1982.
4. CONTROLLING DIMENSION: INCH.

DIM	INCHES		MILLIMETERS	
	MIN	MAX	MIN	MAX
A	1.230	1.265	31.25	32.13
B	0.250	0.270	6.35	6.85
C	0.145	0.175	3.69	4.44
D	0.015	0.020	0.38	0.51
E	0.050 BSC		1.27 BSC	
F	0.040	0.060	1.02	1.52
G	0.100 BSC		2.54 BSC	
J	0.007	0.012	0.18	0.30
K	0.110	0.140	2.80	3.55
L	0.300 BSC		7.62 BSC	
M	0°	15°	0°	15°
N	0.020	0.040	0.51	1.01

P SUFFIX PLASTIC PACKAGE CASE 738-03 ISSUE E

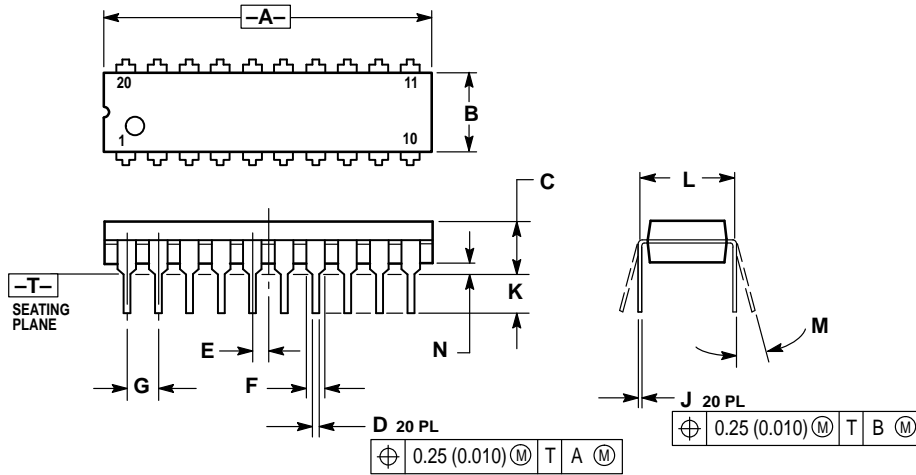

NOTES:

1. DIMENSIONING AND TOLERANCING PER ANSI Y14.5M, 1982.
2. CONTROLLING DIMENSION: INCH.
3. DIMENSION L TO CENTER OF LEAD WHEN FORMED PARALLEL.
4. DIMENSION B DOES NOT INCLUDE MOLD FLASH.

DIM	INCHES		MILLIMETERS	
	MIN	MAX	MIN	MAX
A	1.010	1.070	25.66	27.17
B	0.240	0.260	6.10	6.60
C	0.150	0.180	3.81	4.57
D	0.015	0.022	0.39	0.55
E	0.050 BSC		1.27 BSC	
F	0.050	0.070	1.27	1.77
G	0.100 BSC		2.54 BSC	
J	0.008	0.015	0.21	0.38
K	0.110	0.140	2.80	3.55
L	0.300 BSC		7.62 BSC	
M	0°	15°	0°	15°
N	0.020	0.040	0.51	1.01

MC13280AY MC13281A/B

Motorola reserves the right to make changes without further notice to any products herein. Motorola makes no warranty, representation or guarantee regarding the suitability of its products for any particular purpose, nor does Motorola assume any liability arising out of the application or use of any product or circuit, and specifically disclaims any and all liability, including without limitation consequential or incidental damages. "Typical" parameters which may be provided in Motorola data sheets and/or specifications can and do vary in different applications and actual performance may vary over time. All operating parameters, including "Typicals" must be validated for each customer application by customer's technical experts. Motorola does not convey any license under its patent rights nor the rights of others. Motorola products are not designed, intended, or authorized for use as components in systems intended for surgical implant into the body, or other applications intended to support or sustain life, or for any other application in which the failure of the Motorola product could create a situation where personal injury or death may occur. Should Buyer purchase or use Motorola products for any such unintended or unauthorized application, Buyer shall indemnify and hold Motorola and its officers, employees, subsidiaries, affiliates, and distributors harmless against all claims, costs, damages, and expenses, and reasonable attorney fees arising out of, directly or indirectly, any claim of personal injury or death associated with such unintended or unauthorized use, even if such claim alleges that Motorola was negligent regarding the design or manufacture of the part. Motorola and  are registered trademarks of Motorola, Inc. Motorola, Inc. is an Equal Opportunity/Affirmative Action Employer.

How to reach us:

USA/EUROPE/Locations Not Listed: Motorola Literature Distribution;
P.O. Box 20912; Phoenix, Arizona 85036. 1-800-441-2447 or 602-303-5454

JAPAN: Nippon Motorola Ltd.; Tatsumi-SPD-JLDC, 6F Seibu-Butsuryu-Center,
3-14-2 Tatsumi Koto-Ku, Tokyo 135, Japan. 03-81-3521-8315

MFAX: RMFAX0@email.sps.mot.com - TOUCHTONE 602-244-6609
INTERNET: <http://Design-NET.com>

ASIA/PACIFIC: Motorola Semiconductors H.K. Ltd.; 8B Tai Ping Industrial Park,
51 Ting Kok Road, Tai Po, N.T., Hong Kong. 852-26629298



MOTOROLA



MC13280AY/D

