

7-UNIT 400mA DARLINGTON TRANSISTOR ARRAY WITH CLAMP DIODE
 6249826 MITSUBISHI ELEK (LINEAR) 80C 09272 D7-43-25

DESCRIPTION

The M54531P, 7-channel sink driver, consists of 14 NPN transistors connected to form high current gain driver pairs.

FEATURES

- High output sustaining voltage to 40V
- High output sink current to 400mA
- Integral diodes for transient suppression
- PMOS compatible input
- Wide input voltage range from -40V to +40V
- Wide operating temperature range ($T_a = -20 \sim +75^\circ\text{C}$)

APPLICATION

Relay and printer driver, LED and incandescent display digit driver, Interfacing for standard MOS/BIPOLAR logics

FUNCTION

The M54531P is comprised of seven NPN darlington driver pairs. Each input has a diode and 20kΩ resistor in series to allow a negative voltage input. Between pin 9 and each output, there are integral diodes for inductive load transient suppression. All emitters and the substrate are connected together to pin 8. The outputs are capable of sinking 400mA and will withstand 40V in the OFF state.

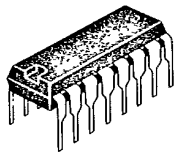

16-pin molded plastic DIP

PIN CONFIGURATION (TOP VIEW)

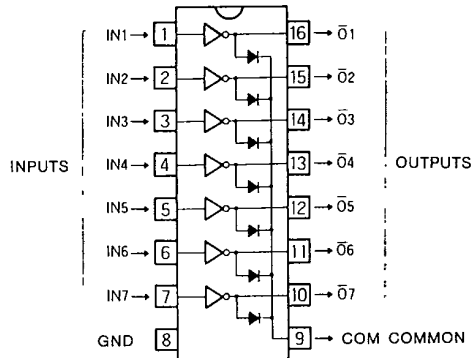

Outline 16P4

CIRCUIT SCHEMATIC

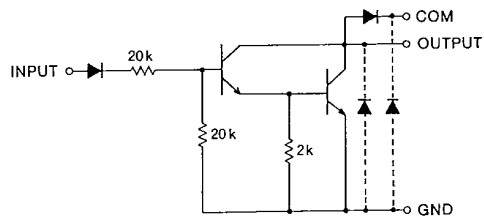

Unit : Ω

ABSOLUTE MAXIMUM RATINGS ($T_a = -20 \sim +75^\circ\text{C}$, unless otherwise noted)

Symbol	Parameter	Conditions	Ratings	Unit
V_{CEO}	Output sustaining voltage	Transistor OFF	-0.5 ~ +40	V
I_C	Collector current	Transistor ON	400	mA
V_i	Input voltage		-40 ~ +40	V
$I_{F(D)}$	Clamp diode forward current		400	mA
$V_{R(D)}$	Clamp diode reverse voltage		40	V
P_d	Power dissipation	$T_a = 25^\circ\text{C}$	1.47	W
T_{opr}	Operating ambient temperature range		-20 ~ +75	$^\circ\text{C}$
T_{stg}	Storage temperature range		-55 ~ +125	$^\circ\text{C}$

7-UNIT 400mA DARLINGTON TRANSISTOR ARRAY WITH CLAMP DIODE

6249826 MITSUBISHI ELEK (LINEAR)

80C 09273

D T-43-25

RECOMMENDED OPERATIONAL CONDITIONS ($T_a = -20 \sim +75^\circ\text{C}$, unless otherwise noted)

Symbol	Parameter	Limits			Unit
		Min	Typ	Max	
V_O	Output voltage	0		40	V
I_C	Collector current per channel	Percent duty cycle less than 8%	0	400	mA
		Percent duty cycle less than 30%	0	200	
V_{IH}	"H" Input voltage	$I_C = 400\text{mA}$	9	35	V
		$I_C = 200\text{mA}$	6	35	
V_{IL}	"L" Input voltage	$I_{O(leak)} = 50\mu\text{A}$	0	1	V

ELECTRICAL CHARACTERISTICS ($T_a = -20 \sim +75^\circ\text{C}$, unless otherwise noted)

Symbol	Parameter	Test conditions	Limits			Unit
			Min	Typ*	Max	
$V_{(BR)CEO}$	Output sustaining voltage	$I_{CEO} = 100\mu\text{A}$	40			V
$V_{CE(sat)}$	Output saturation voltage	$V_i = 9\text{V}, I_C = 400\text{mA}$		1.3	2.4	V
		$V_i = 6\text{V}, I_C = 200\text{mA}$		1	1.6	
I_i	Input current	$V_i = 18\text{V}$		0.85	1.8	mA
		$V_i = 35\text{V}$		2.0	3.8	
I_R	Input leakage current	$V_i = -35\text{V}$			-20	μA
$V_{F(D)}$	Clamp diode forward voltage	$I_{F(D)} = 400\text{mA}$		1.5	2.4	V
$V_{R(D)}$	Clamp diode reverse voltage	$I_{R(D)} = 100\mu\text{A}$	40			V
h_{FE}	DC forward current gain	$V_{CE} = 4\text{V}, I_C = 300\text{mA}, T_a = 25^\circ\text{C}$	1000	3500		-

* : All typical values are at $T_a = 25^\circ\text{C}$.

TYPICAL CHARACTERISTICS

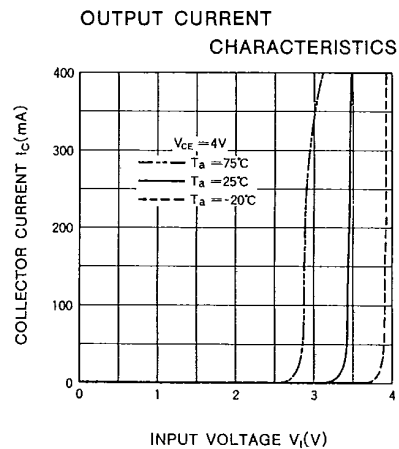
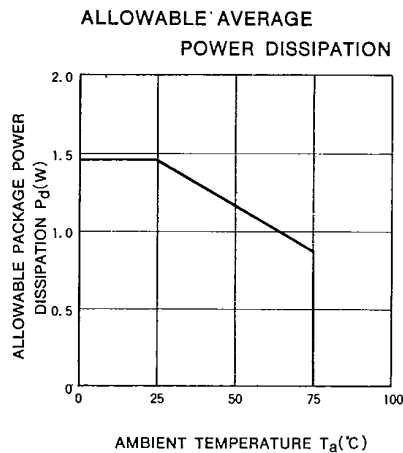

M54531P

6249826 MITSUBISHI ELEK (LINEAR)

80C 09274 D 7-43-25

7-UNIT 400mA DARLINGTON TRANSISTOR ARRAY WITH CLAMP DIODE

ALLOWABLE COLLECTOR CURRENT AS A FUNCTION OF DUTY CYCLE

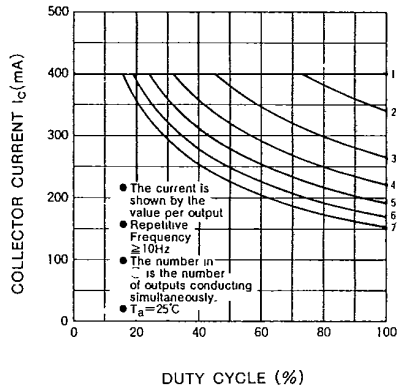

ALLOWABLE COLLECTOR CURRENT AS A FUNCTION OF DUTY CYCLE

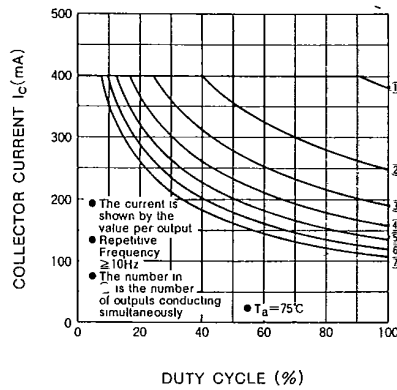

DC CURRENT GAIN CHARACTERISTICS

