HA13605A

Three-Phase Brushless Motor Driver

HITACHI

ADE-207-201A (Z)
2nd. Edition
February, 1998

Description

The HA13605A is a three-phase brushless motor driver IC that provides digital speed control on chip. It was developed for use as the drum motor driver in plain paper copiers and has the following functions and features.

Functions

- Three-phase output circuit that can provide a maximum of 4.5 A at 35 V per phase
- Digital speed control
- Crystal oscillator circuit (10 MHz maximum)
- FG amplifier
- Speed monitor (lock detection output)
- Current control circuit
- Overvoltage protection circuit (OVSD)
- Thermal protection circuit (OTSD)
- Low voltage protection circuit (LVI)
- Forward/reverse switching circuit

Features

- High breakdown voltage, large currents
- Direct PWM drive outputs
- Employs DMOS
- Low on resistance: 0.7 Ω /DMOS maximum
- No lower arm flywheel diode is required

Pin Description

Pin No.	Pin Name	Function
1	V _{cc}	Power supply
2	UOUT	U phase output
3	BOOSTL	Booster pin. (Low side)
4	VOOUT	V phase output
5	RNF	Output current detection
6	WOUT	W phase output
7	BOOSTH	Booster pin. (High side)
8	UIN	U phase input
9	VR1	Charge pump reference voltage pin.
10	VIN	V phase input
11	V _{x1}	Output current control voltage input pin.
12	WIN	W phase input
13	C-PMP	Charge pump output pin. Speed error integration and phase compensation of speed control.
14	FGIN-	FG Amp. (-) input pin
15	FGOUT	FG Amp. output pin
16	FGIN+	FG Amp. (+) input pin
17	DIR	Direction, Rotation direction set up pin
18	PWMOSC	PWM oscillator input pin. Set oscillator frequency.
19	DSEL	Divide select pin (L : 1/3, M : 1/12, M : 1/6)
20	OSCOOUT	Oscillator output
21	READY	Ready pin. Speed monitor pin. (open-collector)
22	OSCCIN	Oscillator input
23	GND	Ground

Pin Arrangement

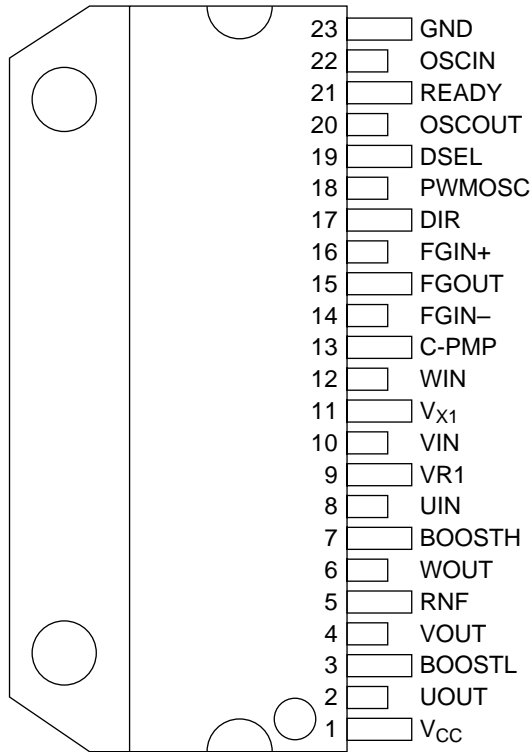

Block Diagram

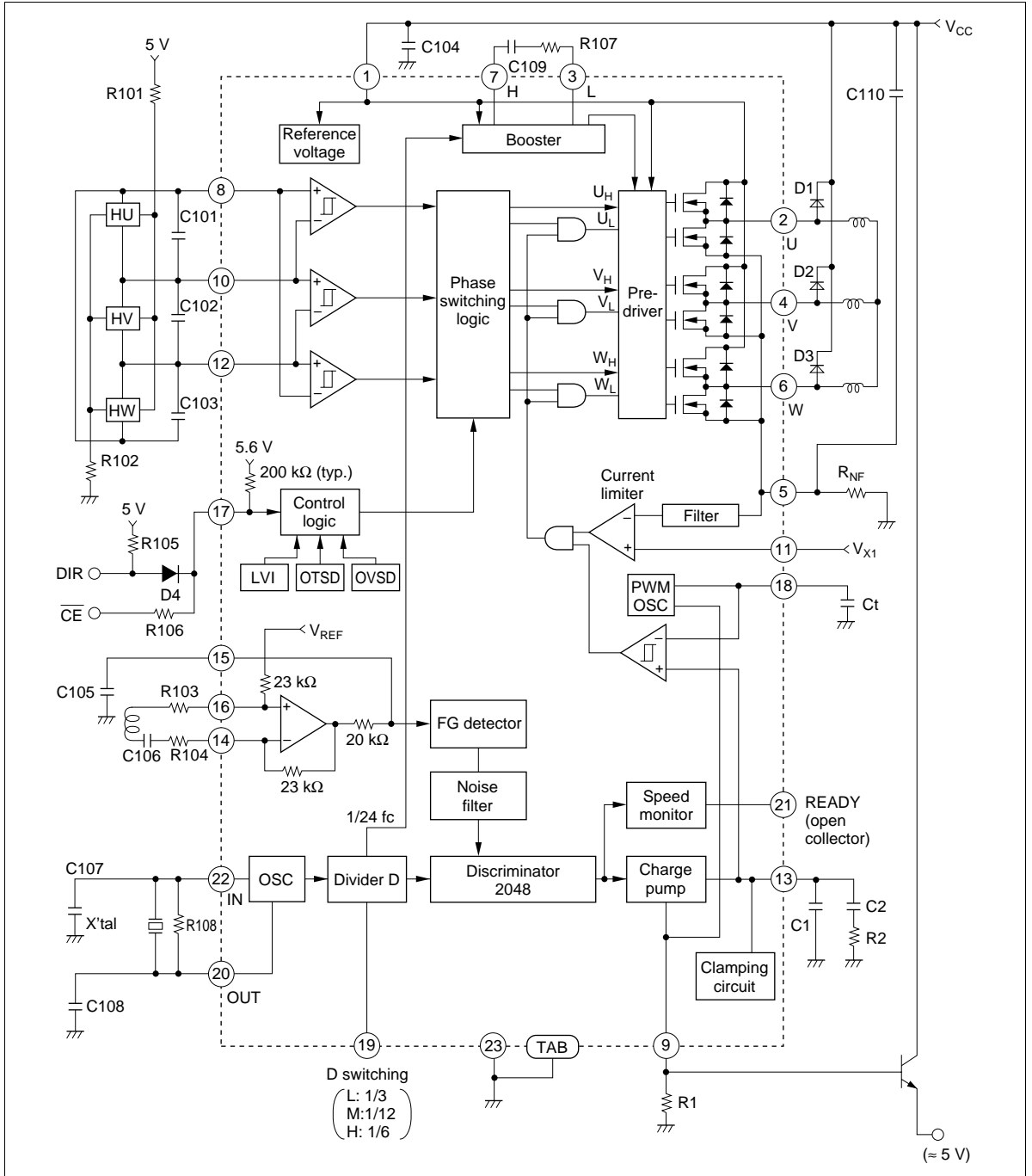

Timing Chart

FWD Mode

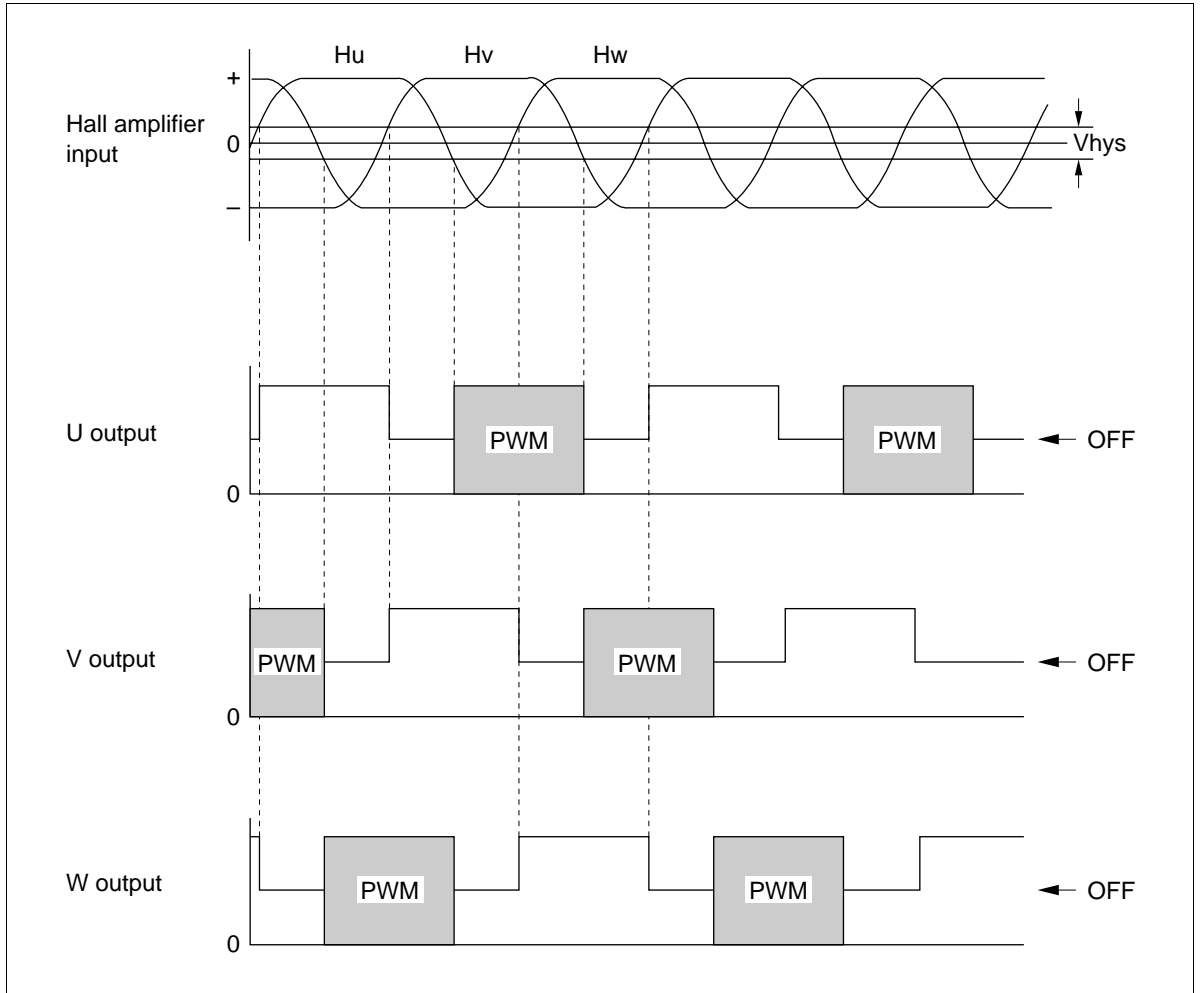

Speed control

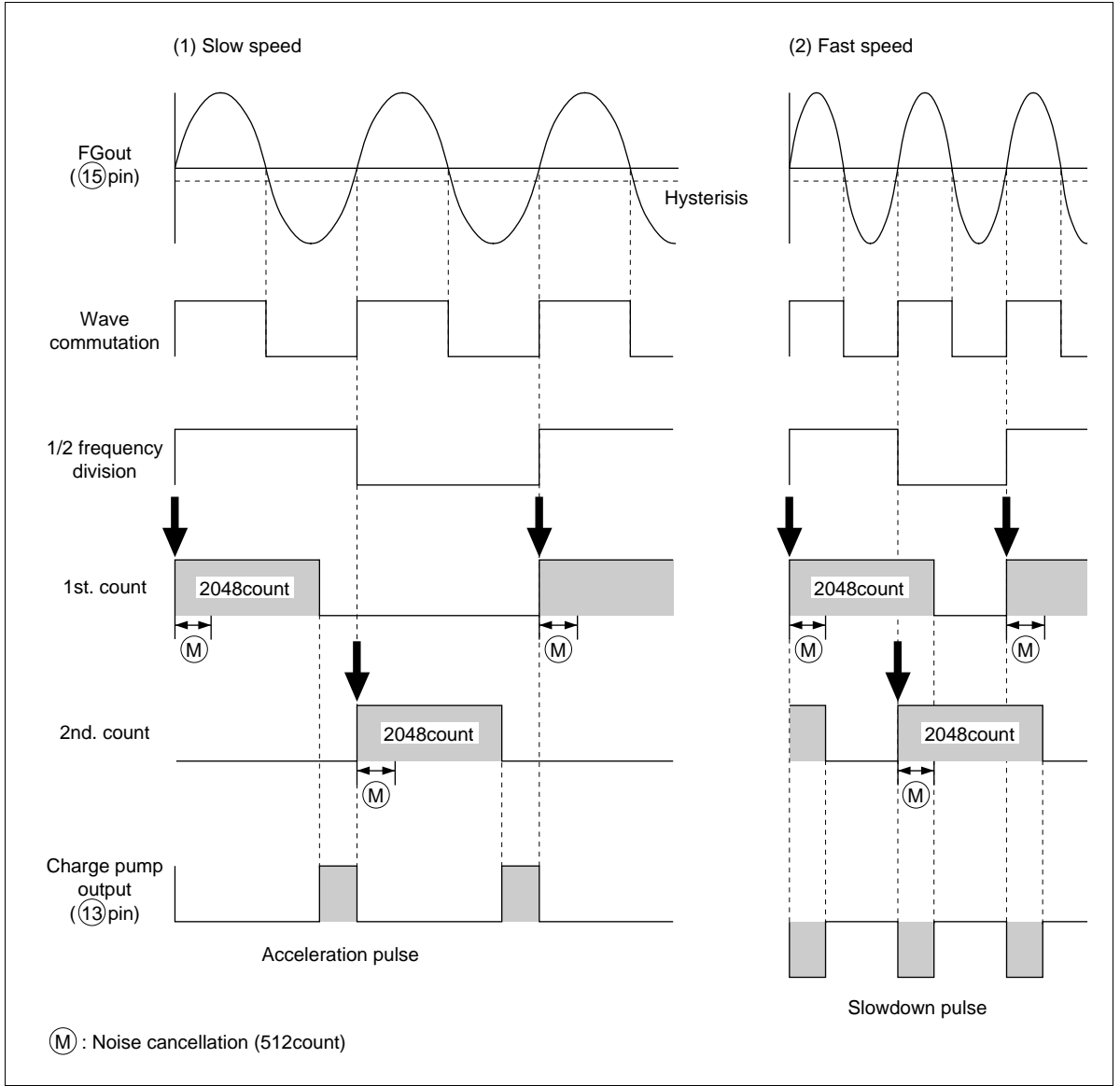

Truth Value Table

DIR Input	Hall Amplifier Input			Output		
	U-V	V-W	W-U	U	V	W
H (stop)	X	X	X	Z	Z	Z
M (reverse)	H	L	H	PWM	H	Z
	H	L	L	PWM	Z	H
	H	H	L	Z	PWM	H
	L	H	L	H	PWM	Z
	L	H	H	H	Z	PWM
	L	L	H	Z	H	PWM
L (forward)	H	L	H	H	PWM	Z
	H	L	L	H	Z	PWM
	H	H	L	Z	H	PWM
	L	H	L	PWM	H	Z
	L	H	H	PWM	Z	H
	L	L	H	Z	PWM	H

Divider Selector

DSEL	D
H	1/6
M	1/12
L	1/3

External Components

Part No.	Recommended Value	Purpose	Notes
R1, R2	—	Integration constants	1
R101, R102	—	Hall bias	9
R103, R104	—	FG amplifier gain setting	2, 8
R105, R106	10 kΩ	Used in interfacing	
R107	4.7 kΩ	Booster stabilization	11
R108	—	Oscillator feedback resistor	10
R _{NF}	—	Current detection	3
C1, C2	—	Integration constants	1
C101, C102, C103	0.047 μF	Stabilization	
C104	≥ 0.1 μF	Power supply bypass	
C105	—	Determines the FG amplifier band	5
C106	—	FG amplifier AC coupling	6
C107, C108	—	Oscillator circuit elements	10
C109	≥ 300 pF	Booster capacitance	11
C110	≥ 47 μF	Stabilization	
Ct	—	PWM oscillator time constant	4
X'tal	—	CLK oscillator	7
D1, D2, D3	—	Regenerative current path	
D4	—	Used in interfacing	

Notes: 1. Use the following formulas to determine target values for these constants.

$$\omega_0 \leq \frac{2\pi f_{FG}}{20} \text{ (rad/s)}$$

$$\frac{R2}{R1} = \frac{7.7J\omega_0 N_o R_m V_{osc}}{K_T V_{R1} (2V_{ps} - 0.83V_E)}$$

$$3.0 \text{ k}\Omega \leq R1 \leq 15 \text{ k}\Omega$$

$$C1 = \frac{1}{\sqrt{10}} \cdot \frac{1}{\omega_0 R2} \text{ (F)}$$

$$C2 = 10C1 \text{ (F)}$$

Where:

ω_0 : Control loop angular frequency

f_{FG} : FG frequency (Hz)

J: Moment of inertia of the motor (kg•m²)

No: Rotation speed (rad/s)

Rm: Motor coil resistance (Ω/T•T)

K_T: Torque constant (N•m/A)

V_E: Motor reverse voltage at speed No (V_{pp}/T•T)

V_{ps}: Power supply voltage (V)

V_{osc}: PWM oscillator amplitude 2.2 (V_{pp}: See the electrical characteristics table.)

V_{R1} : Charge pump reference voltage 5.6 (V: See the electrical characteristics table.)

- The voltage gain (Gfg) of the FG amplifier is determined by the following formula. Here Rfgf is the internal feedback resistance. See the electrical characteristics table.

However, note that R103 must be equal to R104.

$$G_{fg} = \frac{R_{fgf}}{R_{103}}$$

- The output current limit is given by the following formula.

$$I_{omax} = \frac{(V_{X1} - 25 \text{ mV})}{R_{nf}} \quad (\text{A})$$

- The PWM carrier frequency is determined by the following formula. Here VR1 and K are the charge pump voltage and the oscillator amplitude (see the electrical characteristics table), respectively.

$$f_P \doteq \frac{VR1}{K C_t R_1 V_{OSC}} \quad (\text{Hz})$$

- The FG amplifier bandwidth BW is determined by the following formula. Here Rfgo is the pin 15 output resistance. See the electrical characteristics table.

However, when C105 is 0, BW is limited to 8 kHz by the internal capacitance.

$$BW = \frac{1}{2\pi C_{105} R_{fgo}} \quad (\text{Hz})$$

- Determine C106 using the following formula as a rough estimate.

$$C_{106} \geq \frac{1}{\pi(R_{103} + R_{104}) f_{FG}} \quad (\text{F})$$

Consult with the oscillator element manufacturer.

- Relationship of between the CLK frequency f_c and the FG frequency f_{FG} . Are determined by the under table.

D	f_c (Hz)
1/3	$2048.5 \cdot \frac{f_{FG}}{D}$ But rotation response is 80 ppm down
1/6 1/12	$2048.5 \cdot \frac{f_{FG}}{D}$

- If an input of $1.25/G_{FG}$ (Vp-p) or higher is applied, irregular rotation may occur due to FG amplifier saturation.
- The absolute value of the whole amplifier input voltage must be within the in-phase input voltage range.
- This should be decided after consultation with the oscillator manufacturer.
- Determine C109 using the following formula as a rough estimate.

$$3 \text{ k}\Omega \leq R_{107} \leq 6 \text{ k}\Omega$$

$$300\text{pF} < C_{109} \leq \frac{20}{F_c (R_{108} + 200 \Omega)} \quad (\text{F})$$

12. TAB should be connected to pin 23 (GND). The FG amplifier may not operate normally, causing irregular rotation, due to parasitism during phase switching.

Absolute Maximum Ratings (Ta = 25°C)

Item	Symbol	Rated Value	Unit	Notes
Power supply voltage	V _{CC}	45	V	1
Input voltage (1)	V _{in} (1)	-0.3 to 6	V	2
Input voltage (2)	V _{in} (2)	-0.3 to 6	V	3
Instantaneous output current	I _{omax}	4.5 (@T ≤ 400 ms)	A	4
Steady state output current	I _{out} (1)	1.5	A	4
Logic output current	I _{out} (2)	10	mA	5
Output voltage	V _{out}	15	V	5
Allowable power dissipation	P _T	25 (@T _c = 112°C)	W	6
Operating junction temperature	T _{jopr}	-10 to +125	°C	
Storage temperature	T _{stg}	-55 to +125	°C	

Notes: 1. The operating voltage range is as shown below.

$$V_{CC} = 20 \text{ to } 35 \text{ V}$$

2. Applies to the hall amplifier. (Pin 8, Pin 10, Pin 12)
3. Applies to the DIR input pin (Pin 17) and the D switchover input pin (Pin 19).
4. Applies to the U, V, and W output pins (Pins 2, 4, and 6). The operation locus of each TRS must not exceed the ASO range shown in figure 1.
However, there is no particular regulation concerning the recovery current. Refer to figure 2 for the temperature rise in the event of rush.
5. Applies to the speed monitor output (Pin 21).
6. The package thermal resistances are shown below.
 $\theta_{j-c} \leq 1.5^\circ\text{C/W}$ (with an arbitrarily large heat sink)
 $\theta_{j-a} \leq 35^\circ\text{C/W}$ (when mounted on a glass-epoxy PC board)

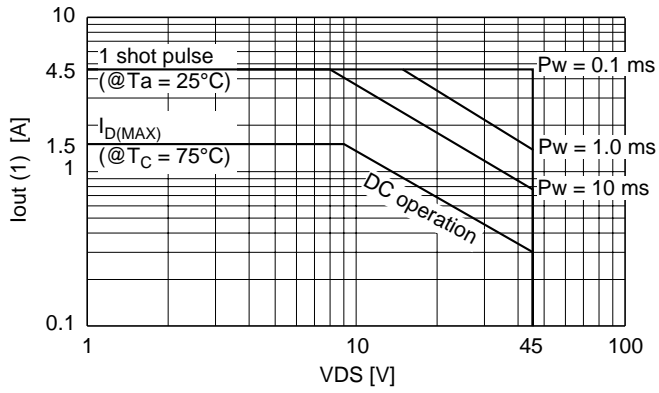

Figure 1 ASO Range

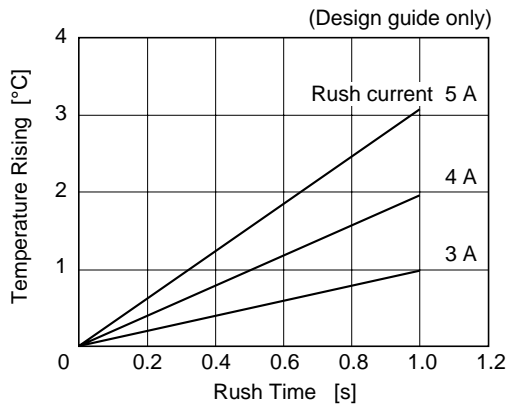

Figure 2 Rush Time vs. Temperature Rising

Electrical Characteristics (Ta = 25°C, V_{CC} = 24 V)

Item	Symbol	Min	Typ	Max	Unit	Test Conditions	Applicable Pins	Notes	
Current drain	I _{cc(1)}	—	—	18	mA	V _{CC} = 35 V R1 = 5.6 kΩ			
	I _{cc(2)}	—	—	20	mA	V _{CC} = 45 V			
Hall amplifier	Input current	I _h	—	—	±20	mA	8, 10, 12		
amplifier	Common mode input voltage range	V _{hc}	1.5	2.5	3.5	V			
	Differential mode input voltage range	V _{hd}	50	—	1000	mV _{PP}			
Output amplifier	Leakage current	I _{cer}	—	—	3	mA	V _{ds} = 35 V	2, 4, 6	
	On resistance	R _{dson}	—	0.5	0.7	Ω	I _o = 1.5 A, T _j = 25°C		1
	Diode voltage	V _{fl}	—	1.2	2.0	V	I _F = 1.5 A, lower arm		
		V _{fu}	0.8	1.2	—	V	I _F = 1.5 A, upper arm		
PWM oscillator & Com-parator	Low level voltage	V _I	1.10	1.30	1.50	V		18	
oscillator	Oscillator amplitude	V _{osc}	2.0	2.2	2.4	V _{PP}			
	Correct coefficient	K	12	14	16	—	R1 = 5.6 kΩ		
FG amplifier and FG detector	Input voltage range	V _{fg}	8	—	300	mV _{PP}	G _{fg} = 32 dB, R103, R104 = 580 Ω	14, 16	
	Differential noise margin	n _d	—	—	1.25	mV _{PP}	G _{fg} = 32 dB, R103, R104 = 580 Ω,		
	Common noise margin	n _c	1.0	—	—	V _{PP}	f = 1kHz		
CLK OSC	Oscillator frequency range	f _c	1.0	—	10.0	MHz	Crystal oscillator	20, 22	
Discriminator	Count	N	—	2048	—	—			
	Operating frequency range	f _{dis}	—	—	3.0	MHz		2	
Charge pump	R1 voltage	V _{R1}	5.1	5.6	6.1	V	R1 = 5.6 kΩ	3	
	Charge current	I _{cp}	0.117	0.130	0.143	A/A	V _o = 1.5 V,	13	4
	Discharge current	I _{cd}	-0.117	-0.130	-0.143	A/A	R1 = 5.6 kΩ		
	Current ratio	I _R	0.8	1.0	1.2	A/A	I _{cp} /I _{cd}		
	Leakage current	I _{off}	—	—	±50	nA	V _o = 3.5 V		
	Clamp voltage	V _{crmp}	4.00	4.25	4.50	V	I _{cp} = 50 mA		

Electrical Characteristics ($T_a = 25^\circ\text{C}$, $V_{CC} = 24\text{ V}$) (cont)

Item		Symbol	Min	Typ	Max	Unit	Test Conditions	Applicable Pins	Notes
Speed monitor	Locking range	ΔNo	—	± 5	—	%		21	5
	Output low level voltage	Vol2	—	—	0.4	V	$I_o = -10\text{ mA}$		
	Output leakage current	Icer2	—	—	± 10	μA	$V_{ce} = 15\text{ V}$		
Current limiter	Input current	Icl	—	—	± 10	μA	$V_{x1} = 0\text{ to }2\text{ V}$	11	
	Offset voltage	Vclos	-10	-25	-40	mV	$V_{x1} = 0.5\text{ to }2\text{ V}$		
LVI	Operating voltage	Vsd	—	—	20	V	Turn on	1	
OVSD	Operating voltage	Vovs	35	—	—	V	Turn on	1	
OTSD	Operating temperature	Tsd	125	160	—	—			9
	Hysteresis	Thys	—	15	—	—			
Input interface	Input current	Ii1, Ii2	-10	—	40	μA	$V_{in} = -0.3\text{ V to }5.25\text{ V}$		
	DIR Input low voltage	Vil1	—	—	1.2	V			
	DIR Input middle voltage	Vim1	1.7	—	3.2	V			
	DIR Input high voltage	Vih1	3.7	—	—	V			
	D Input low voltage	Vil2	—	—	1.5	V			
	D Input middle voltage	Vim2	2.0	—	2.8	V			
Hall amp.	D Input high voltage	Vih2	3.5	—	—	V			
	Hysteresis	Uhys	—	20	—	mV	$R_h = 400\ \Omega$		6, 9
Power drive	Transient response time	tph1	—	—	1	μs	at PWM		7, 9
		tph1	—	—	1	μs	at PWM		
		tr, tf	—	—	300	ns	at PWM		
Filter	Noise cancellation range	Tn1	—	1.0	—	μs			9
PWMOSC & comparator	Oscillation frequency range	fp	2	—	20	kHz			9
	Comparator hysteresis	Vphys	—	50	—	mV			9

Electrical Characteristics (Ta = 25°C, V_{CC} = 24 V) (cont)

Item		Symbol	Min	Typ	Max	Unit	Test Conditions	Applicable Pins	Notes
FG amp. & FG detector	Feedback resistance	Rfgf	—	23	—	kΩ			9
	Output resistance	Rfgo	—	20	—	kΩ			9
	Hysteresis	VZXhys	—	-80	—	mV			9
CLK OSC	Frequency error	Dfc	—	—	±0.01	%	Crystal oscillator		9
	Threshold voltage	Vfth	—	2.7	—	V			9
	Oscillation amplitude	Vfc	—	5.6	—	V _{pp}			9
OVSD	Hysteresis	OVDhys	—	1.5	—	V			9
LVI	Hysteresis	Lhys	—	1.0	—	V			9
Noise filter	Noise cancellation range	Tn2	—	3.0	—	μs	fc = 4 MHz, D = 1/6		8, 9

- Notes:
1. The on resistance per single MOS transistor.
 2. Stipulated for the discriminator input.
 3. See figure 3. See figure 4.
 4. Specified as a ratio to the R1 current.
 5. The speed monitor output is low when the motor is at the set speed.
 6. See figure timing chart.
 7. See figure 5.
 8. Refer to the operation and the formula for determining the maximum cancelable noise width Tn (figure 6).
Noise cancellation is effective only when the FG detector output is low.
 9. Design guide only.

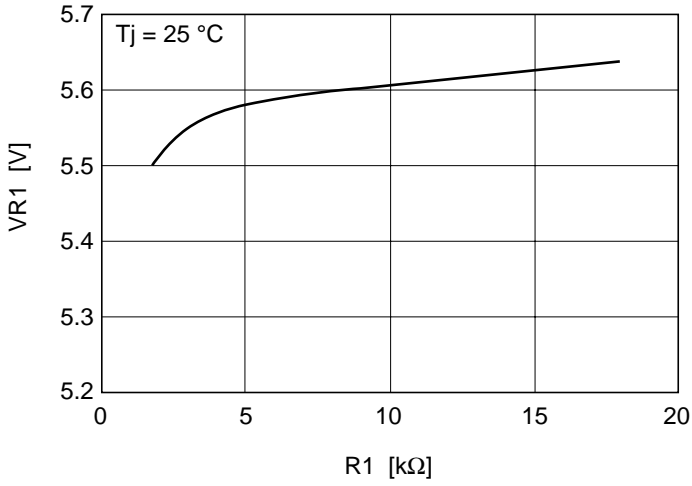

Figure 3 VR1-R1 Characteristics

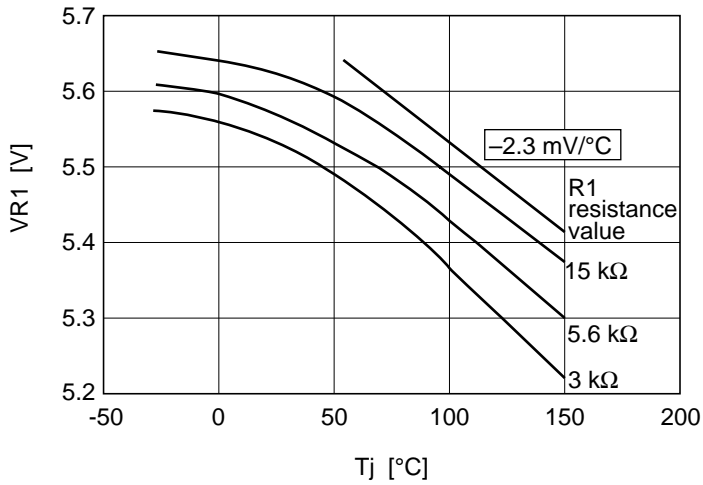

Figure 4 VR1 Temperature Characteristics

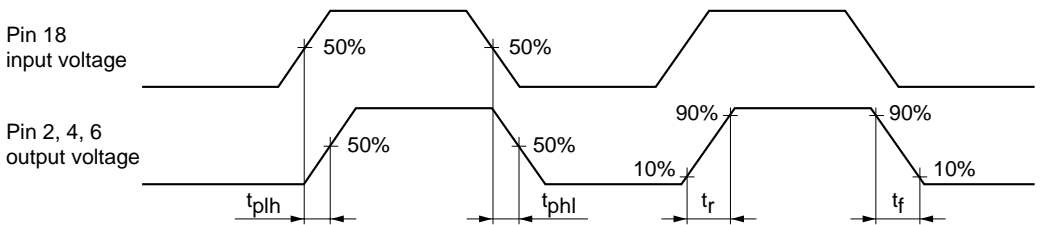

Figure 5

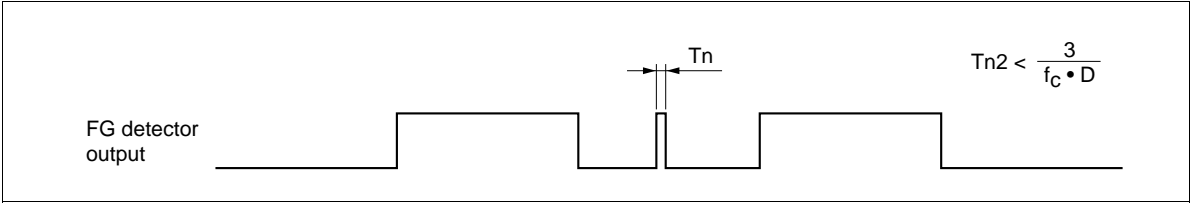

Figure 6

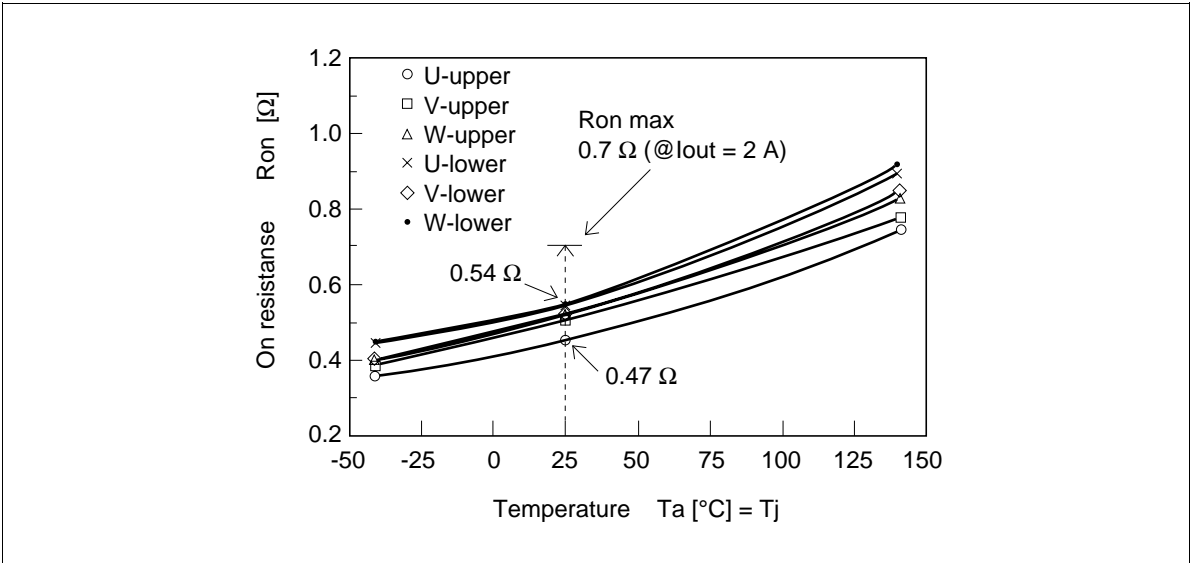

Figure 7 Ron Temperature Dependence Characteristics

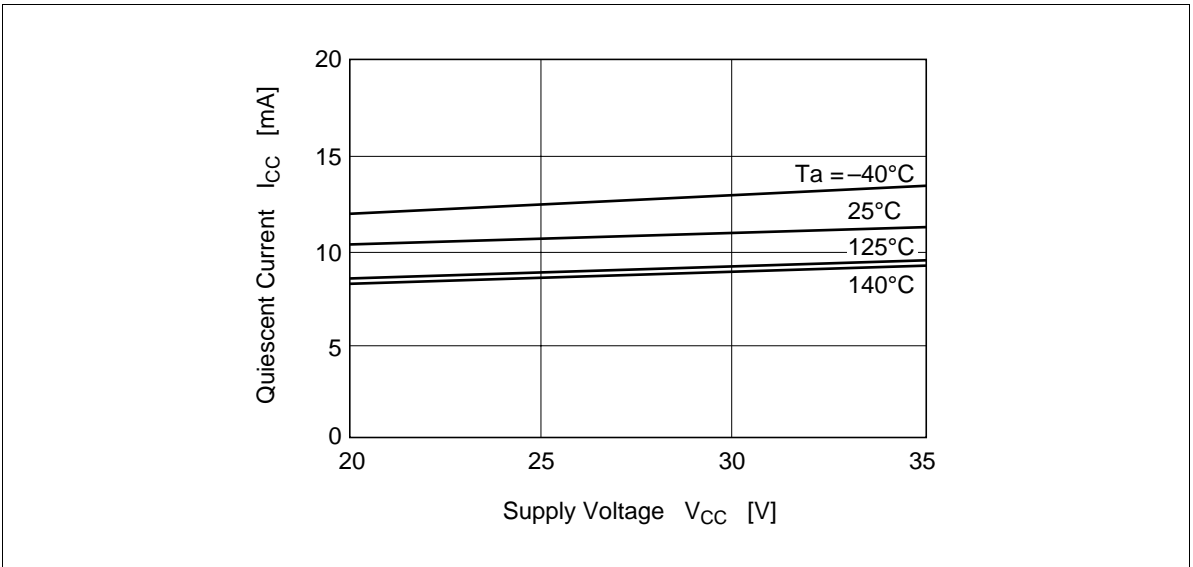
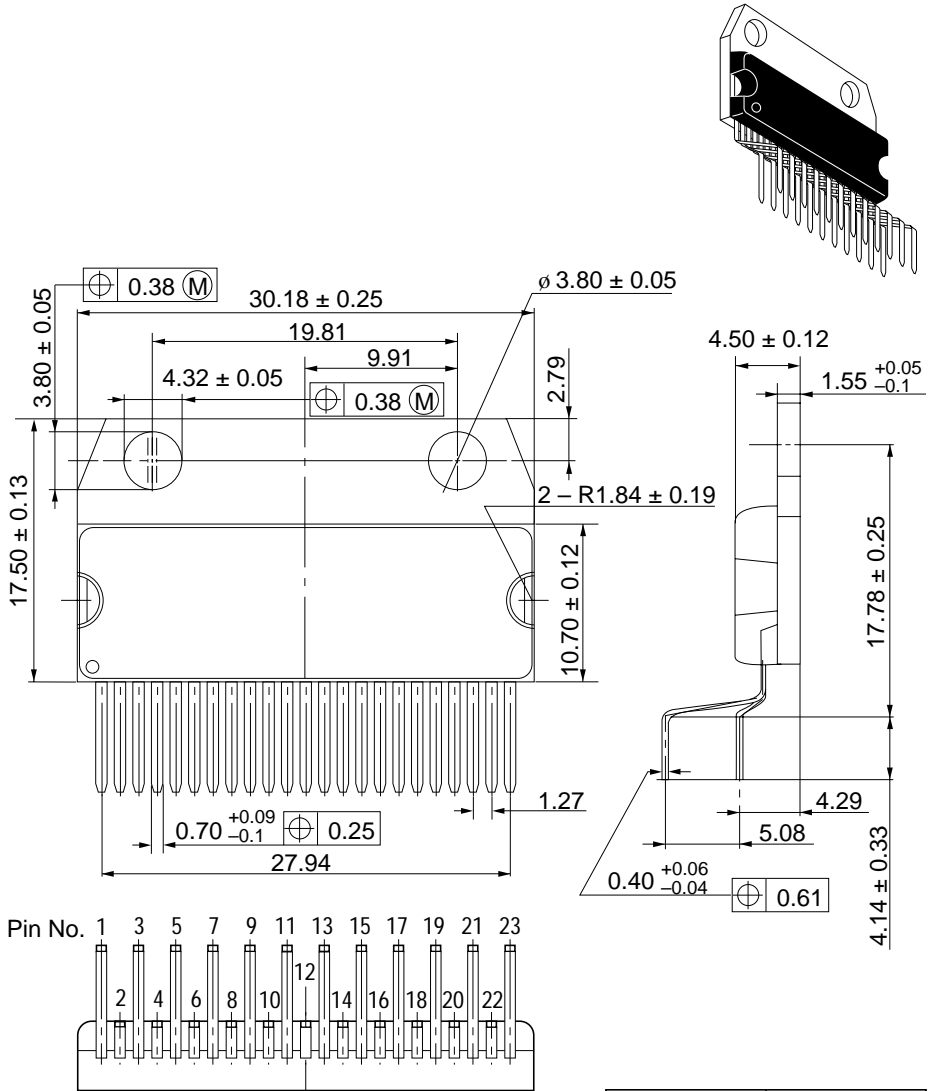

Figure 8 Supply Voltage vs. Quiescent Characteristics

Package Dimensions

Unit: mm



Hitachi code	SP-23TE
EIAJ code	—
JEDEC code	—

Cautions

1. Hitachi neither warrants nor grants licenses of any rights of Hitachi's or any third party's patent, copyright, trademark, or other intellectual property rights for information contained in this document. Hitachi bears no responsibility for problems that may arise with third party's rights, including intellectual property rights, in connection with use of the information contained in this document.
2. Products and product specifications may be subject to change without notice. Confirm that you have received the latest product standards or specifications before final design, purchase or use.
3. Hitachi makes every attempt to ensure that its products are of high quality and reliability. However, contact Hitachi's sales office before using the product in an application that demands especially high quality and reliability or where its failure or malfunction may directly threaten human life or cause risk of bodily injury, such as aerospace, aeronautics, nuclear power, combustion control, transportation, traffic, safety equipment or medical equipment for life support.
4. Design your application so that the product is used within the ranges guaranteed by Hitachi particularly for maximum rating, operating supply voltage range, heat radiation characteristics, installation conditions and other characteristics. Hitachi bears no responsibility for failure or damage when used beyond the guaranteed ranges. Even within the guaranteed ranges, consider normally foreseeable failure rates or failure modes in semiconductor devices and employ systemic measures such as fail-safes, so that the equipment incorporating Hitachi product does not cause bodily injury, fire or other consequential damage due to operation of the Hitachi product.
5. This product is not designed to be radiation resistant.
6. No one is permitted to reproduce or duplicate, in any form, the whole or part of this document without written approval from Hitachi.
7. Contact Hitachi's sales office for any questions regarding this document or Hitachi semiconductor products.

HITACHI

Hitachi, Ltd.

Semiconductor & Integrated Circuits.
Nippon Bldg., 2-6-2, Ohte-machi, Chiyoda-ku, Tokyo 100-0004, Japan
Tel: Tokyo (03) 3270-2111 Fax: (03) 3270-5109

URL North America : <http://semiconductor.hitachi.com/>
 Europe : <http://www.hitachi-eu.com/hel/ecg>
 Asia (Singapore) : <http://www.has.hitachi.com.sg/grp3/sicd/index.htm>
 Asia (Taiwan) : http://www.hitachi.com.tw/E/Product/SICD_Frame.htm
 Asia (HongKong) : <http://www.hitachi.com.hk/eng/bo/grp3/index.htm>
 Japan : <http://www.hitachi.co.jp/Sicd/indx.htm>

For further information write to:

Hitachi Semiconductor
(America) Inc.
179 East Tasman Drive,
San Jose, CA 95134
Tel: <1> (408) 433-1990
Fax: <1> (408) 433-0223

Hitachi Europe GmbH
Electronic components Group
Dornacher Straße 3
D-85622 Feldkirchen, Munich
Germany
Tel: <49> (89) 9 9180-0
Fax: <49> (89) 9 29 30 00

Hitachi Europe Ltd.
Electronic Components Group.
Whitebrook Park
Lower Cookham Road
Maidenhead
Berkshire SL6 8YA, United Kingdom
Tel: <44> (1628) 585000
Fax: <44> (1628) 778322

Hitachi Asia Pte. Ltd.
16 Collyer Quay #20-00
Hitachi Tower
Singapore 049318
Tel: 535-2100
Fax: 535-1533

Hitachi Asia Ltd.
Taipei Branch Office
3F, Hung Kuo Building, No.167,
Tun-Hwa North Road, Taipei (105)
Tel: <886> (2) 2718-3666
Fax: <886> (2) 2718-8180

Hitachi Asia (Hong Kong) Ltd.
Group III (Electronic Components)
7/F., North Tower, World Finance Centre,
Harbour City, Canton Road, Tsim Sha Tsui,
Kowloon, Hong Kong
Tel: <852> (2) 735 9218
Fax: <852> (2) 730 0281
Telex: 40815 HITEC HX

Copyright ' Hitachi, Ltd., 1999. All rights reserved. Printed in Japan.

HITACHI