

**Features**

- 180 MHz bandwidth
- 2000 V/ $\mu$ s slew rate
- Low bias current, 3  $\mu$ A typical
- 100 mA output current
- 5 mA supply current
- Short circuit protected
- Low cost
- Stable with capacitive loads
- Wide supply range  $\pm 5$ V to  $\pm 15$ V
- No thermal runaway

**Applications**

- Op amp output current booster
- Cable/line driver
- A/D input buffer
- Isolation buffer

**Ordering Information**

Part No.	Temp. Range	Package	Outline #
EL2002ACN	0°C to +75°C	P-DIP	MDP0031
EL2002CM	0°C to +75°C	20-Lead SOL	MDP0027
EL2002CN	0°C to +75°C	P-DIP	MDP0031

**General Description**

The EL2002 is a low cost monolithic, high slew rate, buffer amplifier. Built using the Elantec monolithic Complementary Bipolar process, this patented buffer has a  $-3$  dB bandwidth of 180 MHz, and delivers 100 mA, yet draws only 5 mA of supply current. It typically operates from  $\pm 15$ V power supplies but will work with as little as  $\pm 5$ V.

This high speed buffer may be used in a wide variety of applications in military, video and medical systems. Typical examples include fast op-amp output current boosters, coaxial cable drivers and A/D converter input buffers.

Elantec's products and facilities comply with MIL-I-45208A, and other applicable quality specifications. For information on Elantec's processing, see the Elantec document, QRA-1: *Elantec's Processing, Monolithic Integrated Circuits*.

**Connection Diagrams**

EL2002 DIP Pinout

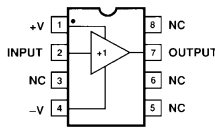

Top View

EL2002 SOL Pinout

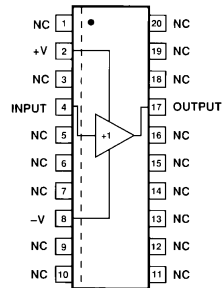

Top View

Manufactured Under U.S. Patent No. 4,833,424 and U.K. Patent No. 2217134.

Note: All information contained in this data sheet has been carefully checked and is believed to be accurate as of the date of publication; however, this data sheet cannot be a "controlled document". Current revisions, if any, to these specifications are maintained at the factory and are available upon your request. We recommend checking the revision level before finalization of your design documentation.

# EL2002C

## Low Power, 180 MHz Buffer Amplifier

### Absolute Maximum Ratings

$V_S$	Supply Voltage ( $V^+ - V^-$ )	$\pm 18V$ or $36V$	$T_A$	Operating Temperature Range: EL2002AC/EL2002C	$0^\circ C$ to $+75^\circ C$
$V_{IN}$	Input Voltage (Note 1)	$\pm 15V$ or $V_S$	$T_J$	Operating Junction Temperature	$150^\circ C$
$I_{IN}$	Input Current (Note 1)	$\pm 50$ mA	$T_{ST}$	Storage Temperature	$-65^\circ C$ to $+150^\circ C$
$P_D$	Power Dissipation (Note 2) Output Short Circuit Duration (Note 3)	See Curves Continuous			

#### Important Note:

All parameters having Min/Max specifications are guaranteed. The Test Level column indicates the specific device testing actually performed during production and Quality inspection. Elantec performs most electrical tests using modern high-speed automatic test equipment, specifically the LTX77 Series system. Unless otherwise noted, all tests are pulsed tests, therefore  $T_J = T_C = T_A$ .

Test Level	Test Procedure
I	100% production tested and QA sample tested per QA test plan QCX0002.
II	100% production tested at $T_A = 25^\circ C$ and QA sample tested at $T_A = 25^\circ C$ , $T_{MAX}$ and $T_{MIN}$ per QA test plan QCX0002.
III	QA sample tested per QA test plan QCX0002.
IV	Parameter is guaranteed (but not tested) by Design and Characterization Data.
V	Parameter is typical value at $T_A = 25^\circ C$ for information purposes only.

### Electrical Characteristics $V_S = \pm 15V$ , $R_S = 50\Omega$ , unless otherwise specified

Parameter	Description	Test Conditions			Limits			EL2002AC EL2002C	Units
		$V_{IN}$	Load	Temp	Min	Typ	Max	Test Level	
$V_{OS}$	Offset Voltage EL2002A/EL2002AC	0	$\infty$	$25^\circ C$	-15	5	+15	I	mV
				$T_{MIN}, T_{MAX}$	-20		+20	III	mV
	EL2002/EL2002C	0	$\infty$	$25^\circ C$	-40	10	+40	I	mV
				$T_{MIN}, T_{MAX}$	-50		+50	III	mV
$I_{IN}$	Input Current EL2002A/EL2002AC	0	$\infty$	$25^\circ C$	-10	3	+10	I	$\mu A$
				$T_{MIN}, T_{MAX}$	-15		+15	III	$\mu A$
	EL2002/EL2002C	0	$\infty$	$25^\circ C$	-15	5	+15	I	$\mu A$
				$T_{MIN}, T_{MAX}$	-20		+20	III	$\mu A$
$R_{IN}$	Input Resistance	+12V	100 $\Omega$	$25^\circ C$	1	3		I	M $\Omega$
				$T_{MIN}, T_{MAX}$	0.1			III	M $\Omega$
$A_{V1}$	Voltage Gain	$\pm 12V$	$\infty$	$25^\circ C$	0.990	0.998		I	V/V
				$T_{MIN}, T_{MAX}$	0.985			III	V/V
$A_{V2}$	Voltage Gain	$\pm 10V$	100 $\Omega$	$25^\circ C$	0.85	0.93		I	V/V
				$T_{MIN}, T_{MAX}$	0.83			III	V/V

# EL2002C

## Low Power, 180 MHz Buffer Amplifier

### Electrical Characteristics $V_S = \pm 15V$ , $R_S = 50\Omega$ , unless otherwise specified — Contd.

Parameter	Description	Test Conditions			Limits			EL2002AC EL2002C	Units
		$V_{IN}$	Load	Temp	Min	Typ	Max	Test Level	
$A_{V3}$	Voltage Gain with $V_S = \pm 5V$	$\pm 3V$	$100\Omega$	$25^\circ C$	0.83	0.91		I	V/V
				$T_{MIN}, T_{MAX}$	0.80			III	V/V
$V_O$	Output Voltage Swing	$\pm 12V$	$100\Omega$	$25^\circ C$	$\pm 10$	$\pm 11$		I	V
				$T_{MIN}, T_{MAX}$	$\pm 9.5$			III	V
$R_{OUT}$	Output Resistance	$\pm 2V$	$100\Omega$	$25^\circ C$		8	13	I	$\Omega$
				$T_{MIN}, T_{MAX}$			15	III	$\Omega$
$I_{OUT}$	Output Current	$\pm 12V$	(Note 4)	$25^\circ C$	+100	+160		I	mA
				$T_{MIN}, T_{MAX}$	$\pm 95$			III	mA
$I_S$	Supply Current	0	$\infty$	$25^\circ C$		5	7.5	II	mA
				$T_{MIN}, T_{MAX}$			10	III	mA
PSRR	Supply Rejection, (Note 5)	0	$\infty$	$25^\circ C$	60	75		I	dB
				$T_{MIN}, T_{MAX}$	50			III	dB
$t_r$	Rise Time	0.5V	$100\Omega$	$25^\circ C$		2.8		V	ns
$t_d$	Propagation Delay	0.5V	$100\Omega$	$25^\circ C$		1.5		V	ns
SR	Slew Rate, (Note 6)	$\pm 10V$	$100\Omega$	$25^\circ C$	1200	2000		IV	$V/\mu s$

Note 1: If the input exceeds the ratings shown (or the supplies) or if the input to output voltage exceeds  $\pm 7.5V$  then the input current must be limited to  $\pm 50$  mA. See the applications section for more information.

Note 2: The maximum power dissipation depends on package type, ambient temperature and heat sinking. See the characteristic curves for more details.

Note 3: A heat sink is required to keep the junction temperature below the absolute maximum when the output is short circuited.

Note 4: Force the input to  $+12V$  and the output to  $+10V$  and measure the output current. Repeat with  $-12 V_{IN}$  and  $-10V$  on the output.

Note 5:  $V_{OS}$  is measured at  $V_{S+} = +4.5V$ ,  $V_{S-} = -4.5V$  and  $V_{S+} = +18V$ ,  $V_{S-} = 18V$ . Both supplies are changed simultaneously.

Note 6: Slew rate is measured between  $V_{OUT} = +5V$  and  $-5V$ .

# EL2002C

## Low Power, 180 MHz Buffer Amplifier

### Typical Performance Curves

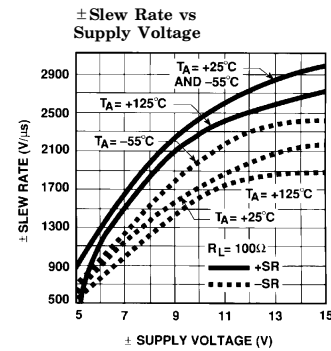
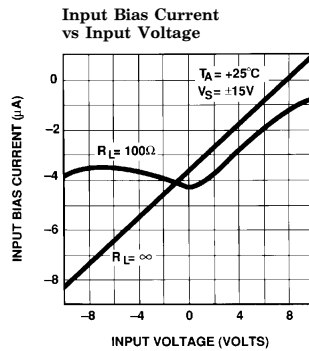
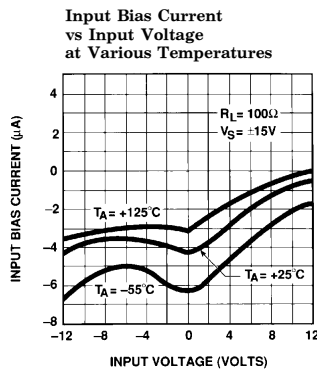
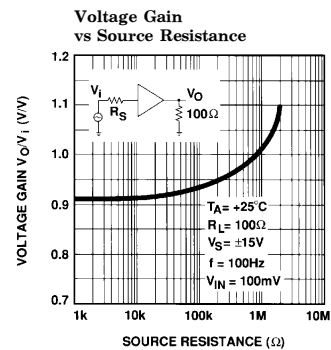
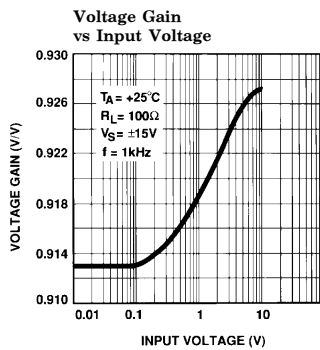
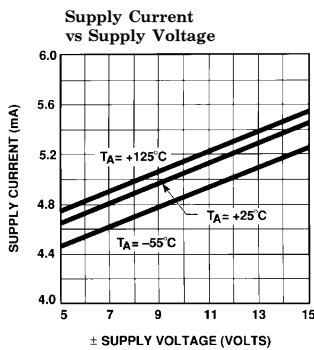
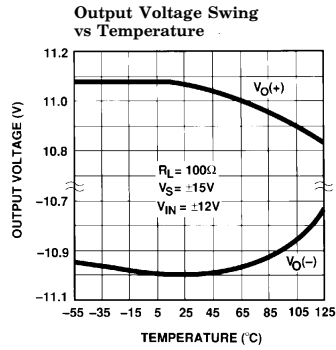
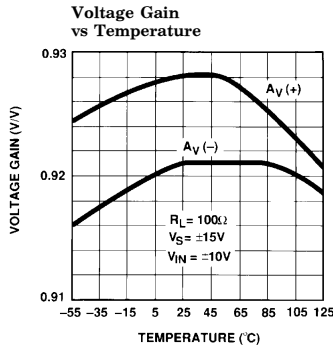
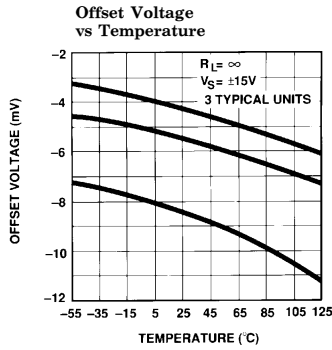

2002-4

# EL2002C

## Low Power, 180 MHz Buffer Amplifier

### Typical Performance Curves — Contd.

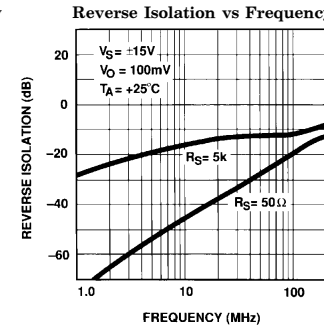
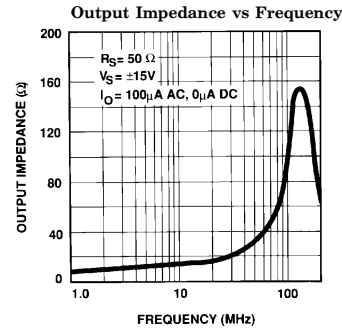
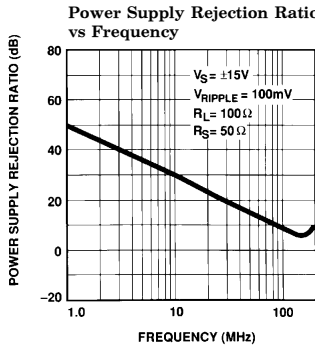
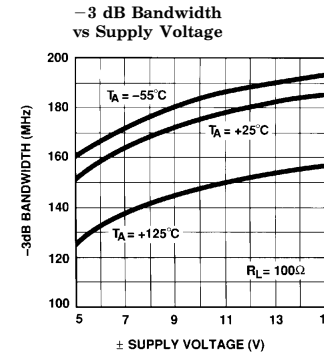
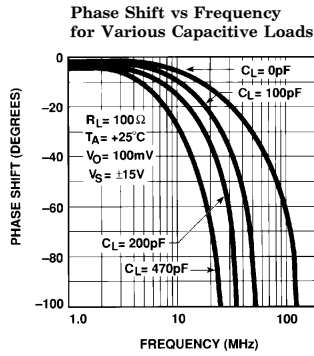
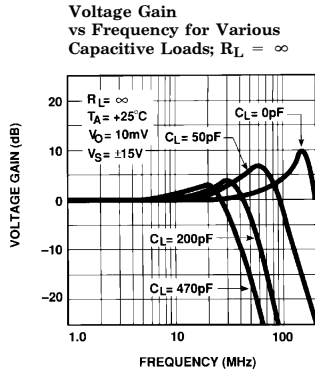
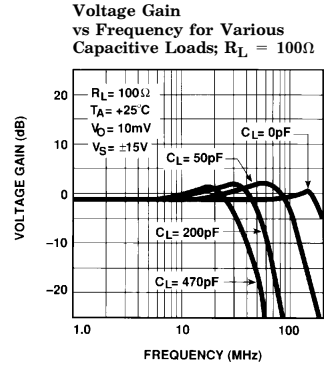
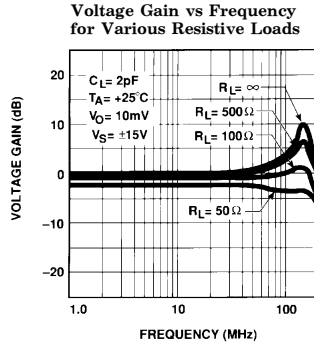
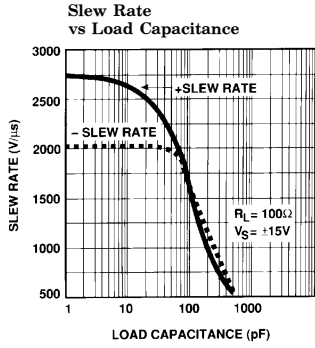

# EL2002C

## Low Power, 180 MHz Buffer Amplifier

### Typical Performance Curves — Contd.

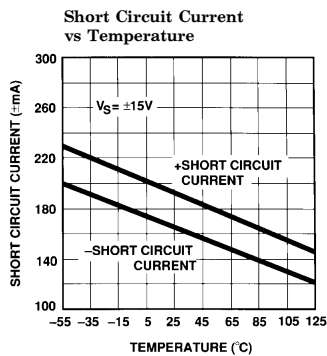
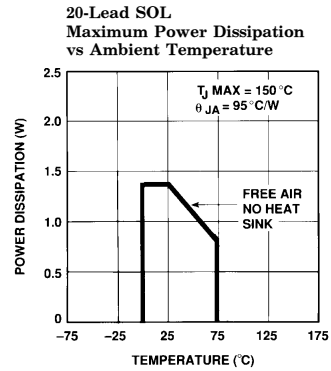
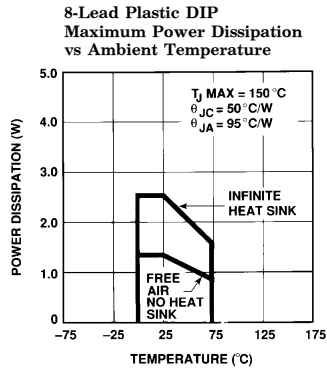
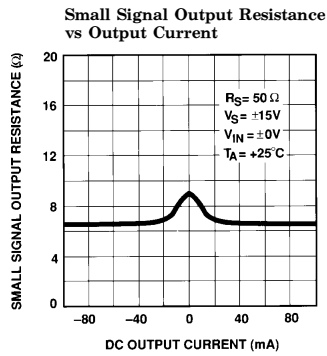

2002-6

### Large Signal Response

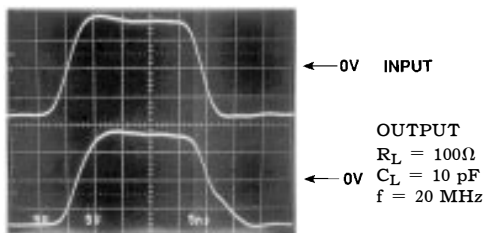

2002-8

### Small Signal Response

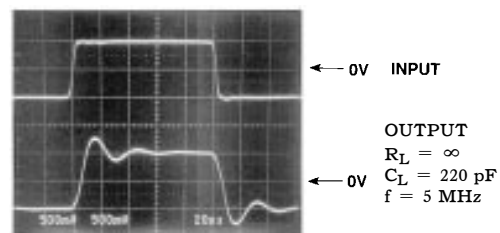

2002-9

# EL2002C

## Low Power, 180 MHz Buffer Amplifier

### Burn-In Circuit

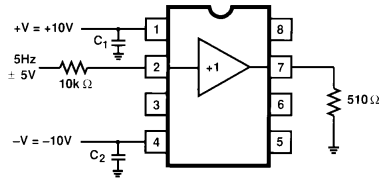

2002-10

### Simplified Schematic

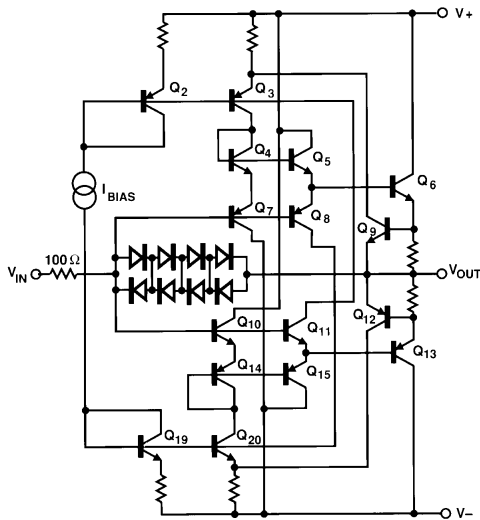

2002-11

### Application Information

The EL2002 is a monolithic buffer amplifier built on Elantec's proprietary Complementary Bipolar process that produces NPN and PNP transistors with essentially identical DC and AC characteristics. The EL2002 takes full advantage of the complementary process with a unique circuit topology.

Elantec has applied for two patents based on the EL2002's topology. The patents relate to the base drive and feedback mechanism in the buffer. This feedback makes 2000 V/ $\mu$ s slew rates with 100 $\Omega$  loads possible with very low supply current.

### Power Supplies

The EL2002 may be operated with single or split supplies with total voltage difference between 10V ( $\pm 5$ V) and 36V ( $\pm 18$ V). It is not necessary to use equal split value supplies. For example  $-5$ V and  $+12$ V would be excellent for signals from  $-2$ V to  $+9$ V.

Bypass capacitors from each supply pin to ground are highly recommended to reduce supply ringing and the interference it can cause. At a minimum, 1  $\mu$ F tantalum capacitor with short leads should be used for both supplies.

### Input Characteristics

The input to the EL2002 looks like a resistance in parallel with about 3.5 pF in addition to a DC bias current. The DC bias current is due to the miss-match in beta and collector current between the NPN and PNP transistors connected to the input pin. The bias current can be either positive or negative. The change in input current with input voltage ( $R_{IN}$ ) is affected by the output load, beta and the internal boost.  $R_{IN}$  can actually appear negative over portions of the input range; typical input current curves are shown in the characteristic curves. Internal clamp diodes from the input to the output are provided. These diodes protect the transistor base emitter junctions and limit the boost current during slew to avoid saturation of internal transistors. The diodes begin conduction at about  $\pm 2.5$ V input to output differential. When that happens the input resistance drops dramatically. The diodes are rated at 50 mA. When conducting they have a series resistance of about 20 $\Omega$ . There is also 100 $\Omega$  in series with the input that limits input current. Above  $\pm 7.5$ V differential input to output, additional series resistance should be added.

### Source Impedance

The EL2002 has good input to output isolation. When the buffer is not used in a feedback loop, capacitive and resistive sources up to 1 MHz present no oscillation problems. Care must be used in board layout to minimize output to input coupling. CAUTION: When using high source impedances ( $R_S > 100$  k $\Omega$ ), significant gain errors can be observed due to output offset, load resistor, and the action of the boost circuit. See typical performance curves.

# ***EL2002C***

## ***Low Power, 180 MHz Buffer Amplifier***

### **EL2002 Macromodel**

```

* Connections:      + input
*                  |      + Vsupply
*                  |      |      - Vsupply
*                  |      |      |      output
*                  |      |      |      |
.subckt M2002      2      1      4      7
* Input Stage
e1 10 0 2 0 1.0
r1 10 0 1K
rh 10 11 150
ch 11 0 2pF
rc 11 12 100
cc 12 0 3pF
e2 13 0 12 0 1.0
* Output Stage
q1 4 13 14 qp
q2 1 13 15 qn
q3 1 14 16 qn
q4 4 15 19 qp
r2 16 7 1
r3 19 7 1
i1 1 14 2mA
i2 15 4 2mA
* Bias Current
iin + 2 0 3uA
* Models
.model qn npn(is = 5e-15 bf = 150 rb = 200 ptf = 45 tf = 0.1nS)
.model qp pnp(is = 5e-15 bf = 150 rb = 200 ptf = 45 tf = 0.1nS)
.ends

```



# ***EL2002C***

***Low Power, 180 MHz Buffer Amplifier***

## **EL2002 Macromodel — Contd.**

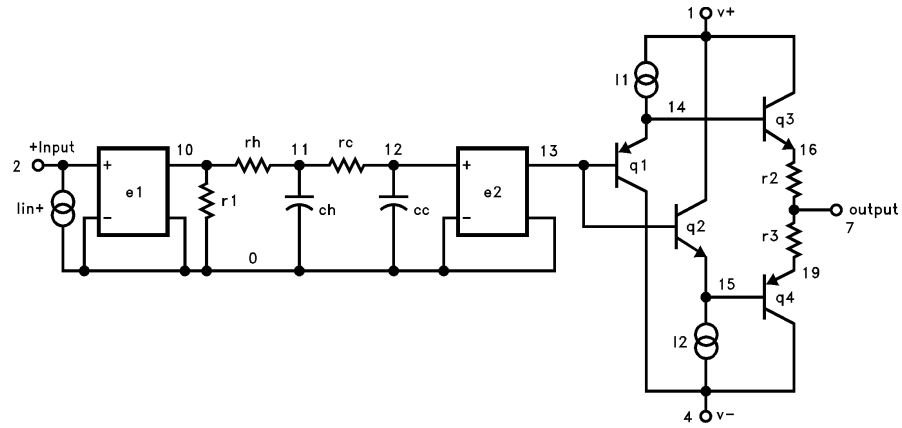

2002-12

**BLANK**

BLANK

# ***EL2002C***

## ***Low Power, 180 MHz Buffer Amplifier***

### **General Disclaimer**

Specifications contained in this data sheet are in effect as of the publication date shown. Elantec, Inc. reserves the right to make changes in the circuitry or specifications contained herein at any time without notice. Elantec, Inc. assumes no responsibility for the use of any circuits described herein and makes no representations that they are free from patent infringement.

***élantec***  
HIGH PERFORMANCE ANALOG INTEGRATED CIRCUITS

### **Elantec, Inc.**

1996 Tarob Court

Milpitas, CA 95035

Telephone: (408) 945-1323

(800) 333-6314

Fax: (408) 945-9305

European Office: 44-71-482-4596

### **WARNING — Life Support Policy**

Elantec, Inc. products are not authorized for and should not be used within Life Support Systems without the specific written consent of Elantec, Inc. Life Support systems are equipment intended to support or sustain life and whose failure to perform when properly used in accordance with instructions provided can be reasonably expected to result in significant personal injury or death. Users contemplating application of Elantec, Inc. products in Life Support Systems are requested to contact Elantec, Inc. factory headquarters to establish suitable terms & conditions for these applications. Elantec, Inc.'s warranty is limited to replacement of defective components and does not cover injury to persons or property or other consequential damages.