

## All Band TV Tuner IC (VHF-CATV-UHF)

**Description**

The CXA3125N is a TV tuner IC which integrates local oscillator and mixer circuits for VHF band, local oscillator and mixer circuits for UHF band, and an IF amplifier onto a single chip. This IC adopts a 16-pin SSOP package and is suitable for miniaturizing voltage synthesizer tuner.

**Features**

- Low noise figure
- Superior cross modulation
- Low power consumption (5 V, 43 mA typ.)
- IF output can be selected from symmetrical or asymmetrical
- SSOP 16-pin package

**Applications**

- TV tuners
- VCR tuners
- CATV tuners

**Structure**

Bipolar silicon monolithic IC

16 pin SSOP (Plastic)

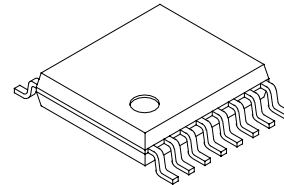
**Absolute Maximum Ratings** (Ta=25 °C)

• Supply voltage	V <sub>CC</sub>	-0.3 to +5.5	V
• Storage temperature	T <sub>stg</sub>	-55 to +150	°C
• Allowable power dissipation	P <sub>D</sub>	625	mW

(when mounted on a printed circuit board)

**Operating Conditions**

• Supply voltage	V <sub>CC</sub>	4.75 to 5.30	V
• Operating temperature	T <sub>opr</sub>	-20 to +75	°C

Sony reserves the right to change products and specifications without prior notice. This information does not convey any license by any implication or otherwise under any patents or other right. Application circuits shown, if any, are typical examples illustrating the operation of the devices. Sony cannot assume responsibility for any problems arising out of the use of these circuits.

Block Diagram and Pin Configuration

CXA3125N

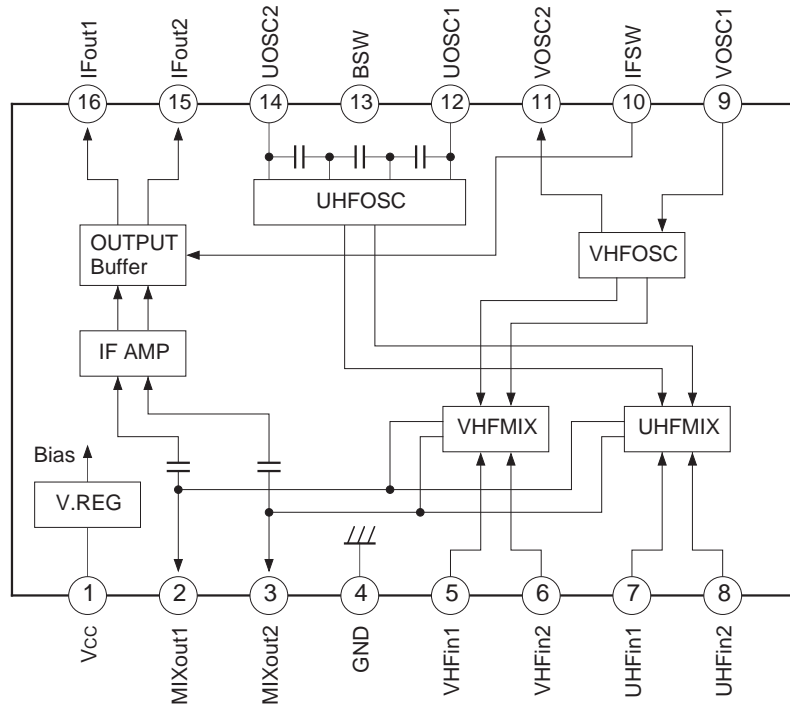

Pin Description and Equivalent Circuit

Pin No.	Symbol	Typical pin voltage (V)	Equivalent circuit	Description
1	Vcc	5.0		Power supply.
2	MIXout1	During VHF reception 4.4 During UHF reception 4.3		Mixer outputs and IF amplifier inputs. These pins are output with open collector, and they must be connected to power supply via load.
3	MIXout2	4.4 4.3		
4	GND	0		GND.
5	VHFin1	2.4 0		VHF inputs. Normally a capacitor is connected at Pin 5 to GND and Pin 6 is used for input.
6	VHFin2	2.4 0		
7	UHFin1	0 2.4		UHF inputs. Symmetrical input to Pins 7 and 8 or a capacitor is connected at Pin 8 to GND and Pin 7 is used for input.
8	UHFin2	0 2.4		
9	VOOSC1	3.1 3.2		External resonance circuit connection for VHF oscillators.
11	VOOSC2	4.0 5.0		

Pin No.	Symbol	Typical pin voltage (V)	Equivalent circuit	Description
10	IFSW	0.8 (when open)		Symmetrical/asymmetrical selection of IF output. Asymmetrical output is selected for open state; symmetrical output, for connecting to GND. When used as an asymmetrical output, connect to GND with a capacitor.
12	UOSC1	3.2 3.0		External resonance circuit connection for UHF oscillators.
14	UOSC2	3.2 3.0		
13	BSW	—		Band switching. UHF operation when 3 V or more voltage is applied externally, and VHF operation when 0.5 V or less voltage is applied.
15	IFout2	During symmetrical output 3.0 During asymmetrical output 4.3		IF outputs during symmetrical output. The reverse phase signal to Pin 16 is output during symmetrical output. When asymmetrical output is selected, the signal is not output.
16	IFout1	During symmetrical output 3.0 During asymmetrical output 2.5		IF outputs.

**Electrical Characteristics**

See the Electrical Characteristics Measurement Circuits 1 and 2.

(Ta=25 °C, Vcc=5 V)

Item	Symbol	Measurement conditions	Min.	Typ.	Max.	Unit
Circuit current	IccVU	VHF operation asymmetrical output no input signal	32	43	52	mA
	IccVB	VHF operation symmetrical output no input signal	35	46	55	mA
	IccUU	UHF operation asymmetrical output no input signal	33	44	53	mA
	IccUB	UHF operation symmetrical output no input signal	36	47	56	mA
Conversion gain *1	CG1U	VHF operation f <sub>RF</sub> =55 MHz asymmetrical output	22	25	28	dB
	CG2U	VHF operation f <sub>RF</sub> =360 MHz asymmetrical output	22	25	28	dB
	CG3U	UHF operation f <sub>RF</sub> =360 MHz asymmetrical output	27	30	33	dB
	CG4U	UHF operation f <sub>RF</sub> =800 MHz asymmetrical output	27	30	33	dB
	CG1B	VHF operation f <sub>RF</sub> =55 MHz symmetrical output*6	26	29	32	dB
	CG2B	VHF operation f <sub>RF</sub> =360 MHz symmetrical output*6	26	29	32	dB
	CG3B	UHF operation f <sub>RF</sub> =360 MHz symmetrical output*6	31	34	37	dB
	CG4B	UHF operation f <sub>RF</sub> =800 MHz symmetrical output*6	31	34	37	dB
Noise figure *1, *2	NF1	VHF operation f <sub>RF</sub> =55 MHz asymmetrical output		11	15	dB
	NF2	VHF operation f <sub>RF</sub> =360 MHz asymmetrical output		11	15	dB
	NF3	UHF operation f <sub>RF</sub> =360 MHz asymmetrical output		9	12	dB
	NF4	UHF operation f <sub>RF</sub> =800 MHz asymmetrical output		9.5	12.5	dB
1 % cross modulation *1 *3	CM1	VHF operation f <sub>D</sub> =55 MHz f <sub>UD</sub> =±12 MHz asymmetrical output	96	100		dBμ
	CM2	VHF operation f <sub>D</sub> =360 MHz f <sub>UD</sub> =±12 MHz asymmetrical output	96	100		dBμ
	CM3	UHF operation f <sub>D</sub> =360 MHz f <sub>UD</sub> =±12 MHz asymmetrical output	90	94		dBμ
	CM4	UHF operation f <sub>D</sub> =800 MHz f <sub>UD</sub> =±12 MHz asymmetrical output	90	94		dBμ
Maximum output power	Pomax (sat)	50 Ω load, asymmetrical output		+10		dBm
Switch ON drift *4	Δfsw1	VHF operation f <sub>OSC</sub> =100 MHz			±300	kHz
	Δfsw2	VHF operation f <sub>OSC</sub> =405 MHz			±400	kHz
	Δfsw3	UHF operation f <sub>OSC</sub> =405 MHz			±400	kHz
	Δfsw4	UHF operation f <sub>OSC</sub> =845 MHz			±400	kHz
+B drift *5	Δfst1	VHF operation f <sub>OSC</sub> =100 MHz			±200	kHz
	Δfst2	VHF operation f <sub>OSC</sub> =405 MHz			±250	kHz
	Δfst3	UHF operation f <sub>OSC</sub> =405 MHz			±250	kHz
	Δfst4	UHF operation f <sub>OSC</sub> =845 MHz			±250	kHz
Band switch voltage	VswV	VHF operation	0		0.5	V
	VswU	UHF operation	3		5.5	V

\*1 Input level -40 dBm, Value measured with untuned input.

\*2 Noise figure is the NF meter direct-reading value (DSB measurement).

\*3 Value with a desired reception signal input level of -30 dBm, an interference of 100 kHz at ±12 MHz : 30 % AM, and an interference signal level where S/I=46 dB measured with a spectrum analyzer.

\*4 Frequency variation from 3 seconds to 3 minutes after switch ON.

\*5 Frequency variation when Vcc=5 V ±5 % variation.

\*6 Value which is measured as 410 Ω load impedance and compensated loss by 180 Ω resistor connected to Pins 15 and 16.

Electrical Characteristics Measurement Circuit 1 (asymmetrical output)

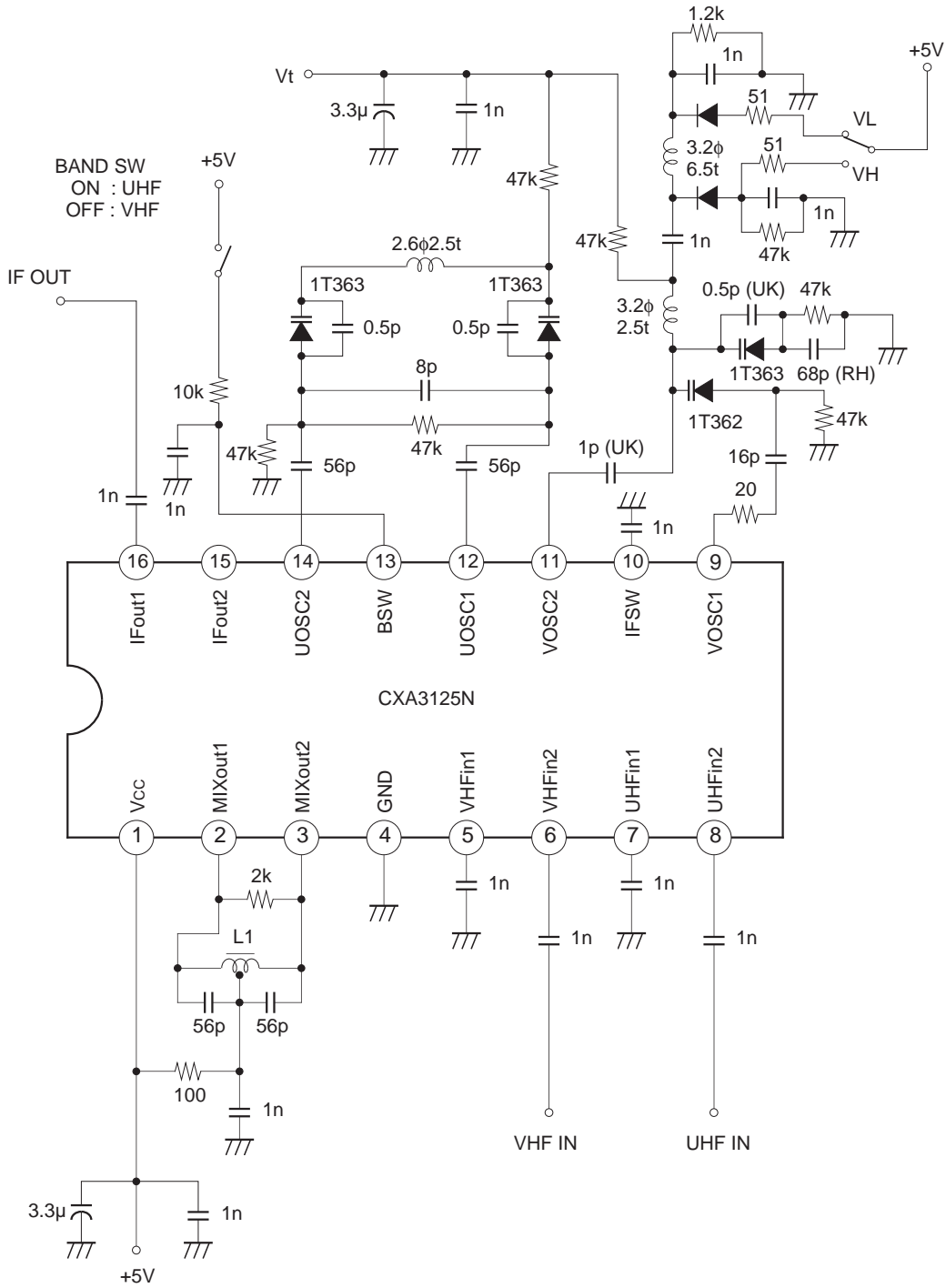

L1 is a pentagonal coil 4.5 t/4.5 t  
 L without indication is an air-core coil of 0.5 mm diameter.

These components value are the setting for USA frequency variation range.

Electrical Characteristics Measurement Circuit 2 (symmetrical output)

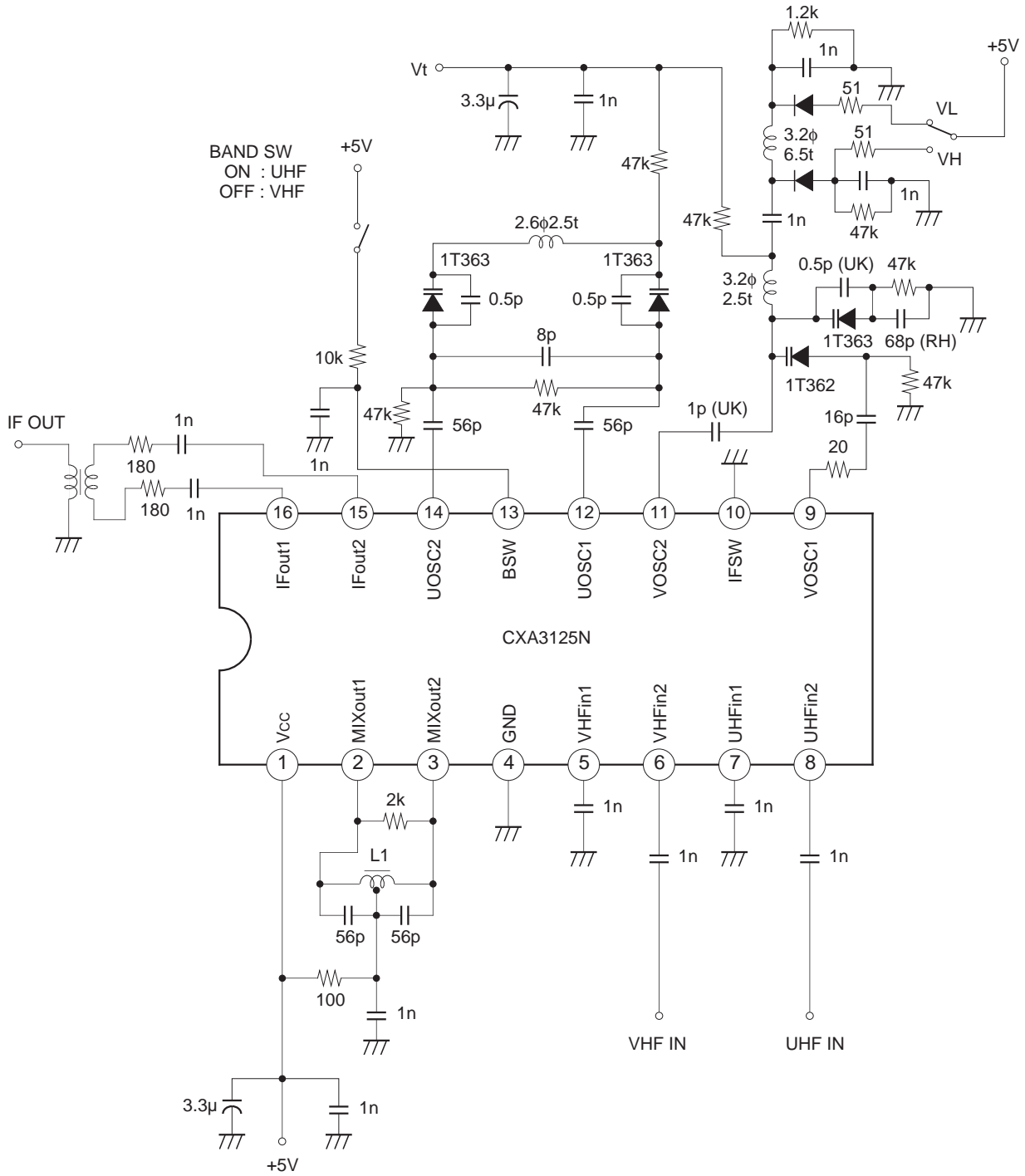

L1 is a pentagonal coil 4.5 t/4.5 t

L without indication is an air-core coil of 0.5 mm diameter.

These components value are the setting for USA frequency variation range.

## Description of Operation

(See the Electrical Characteristics Measurement Circuit.)

### VHF oscillator circuit

This circuit is a differential amplifier type oscillator circuit. Pin 11 is the output and Pin 9 is the input.

Oscillation is performed by connecting an LC resonance circuit including a varicap to Pin 11 via coupled capacitance, inputting to Pin 9 with feedback capacitance, and applying positive feedback.

Note that if the capacitance across Pins 9 and 11 is too large, positive feedback may be applied via a parasitic capacitance causing undesired stray oscillation.

### VHF mixer circuit

The mixer circuit employs a double symmetrical mixer with little local oscillation signal leakage. The RF signal is input to Pins 6 and 7. During normal use, the RF signal is input to one pin while the other pin is connected to GND. The RF signal is converted to IF frequency by the signal supplied from the oscillator and then output to Pins 2 and 3. Pins 2 and 3 are open collectors, so power must be supplied externally. Connect to Vcc through L which configures external filter or resistor. The electric potential of Pins 2 and 3 at this time must be DC 4.0 V or more.

### UHF oscillator circuit

This oscillator circuit is designed so that two collector ground type Colpitts oscillators perform differential oscillation operation via an LC resonance circuit including a varicap. Feedback capacitance is built into IC, and an LC resonance circuit including a varicap is connected between Pins 12 and 14 via coupled capacitance.

### UHF mixer circuit

This circuit employs a double symmetrical mixer like the VHF mixer circuit. The RF signal is input to Pins 7 and 8. There is a symmetrical input at the differential from both edges of the secondary coil of the pre-stage double-tuned circuits, or an asymmetrical input to Pin 7 with a capacitor connected at Pin 8 to GND. Otherwise, the conditions and usage are the same as those for the VHF mixer circuit.

### IF amplifier circuit

The signals frequency converted by the mixer are output from Pins 2 and 3, and at the same time are AC coupled inside the IC and input to the IF amplifier. Single-tuned filters are connected to Pins 2 and 3 in order to improve the interference characteristics of the IF amplifier.

The signal amplified by the IF amplifier is output with symmetrical or asymmetrical output format. Selecting symmetrical or asymmetrical is performed at Pin 10. Asymmetrical output when Pin 10 is for open state; symmetrical output when connected to GND. During symmetrical output, SAW filter direct connection is possible and during asymmetrical output, output stage drive capability is increased to drive 75  $\Omega$  load. During asymmetrical output, output is performed from Pin 16, and during symmetrical output, output is performed from Pins 15 and 16. The output impedance is approximately 35  $\Omega$  for symmetrical output; 30  $\Omega$  for asymmetrical output. When asymmetrical output is selected, connect Pin 10 to GND through capacitor.

### U/V switch circuit

UHF operation is chosen by applying voltage of 3 V or more to Pin 13 VHF operation for 0 V or open.



**Notes on Operation**

1. Care should be taken for grounding, etc. when placing external parts as high operating frequencies are present.
2. The GND pattern also serves as heat dissipation pins, care should be taken to prevent heat problems.
3. Care should also be taken to prevent electrostatic damage because of using high frequency process.

Example of Representative Characteristics

Supply voltage vs. Circuit current  
(for asymmetrical output)

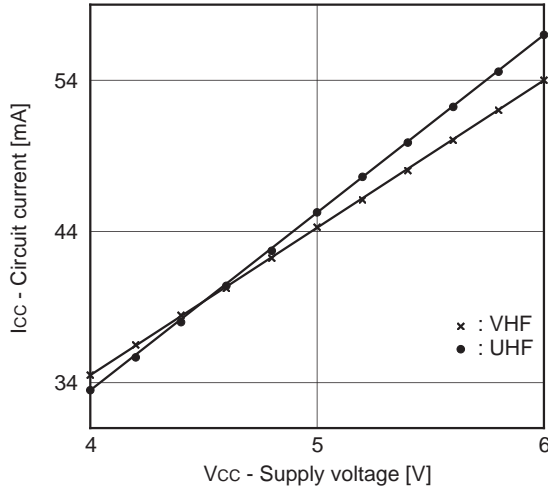

Reception frequency vs. Conversion gain  
(for asymmetrical output)

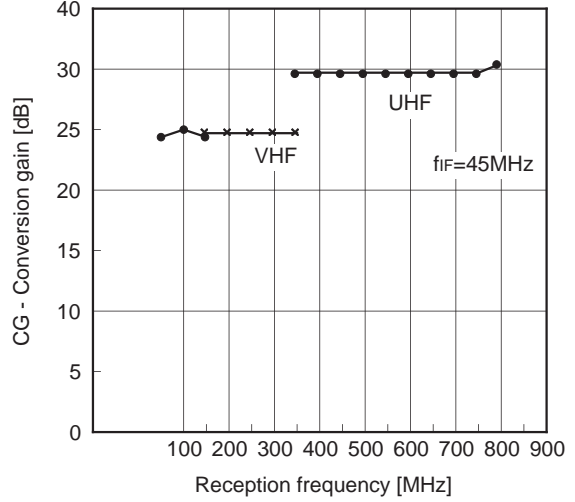

Reception frequency vs. Noise figure  
(untuned input, for asymmetrical output, DSB display)

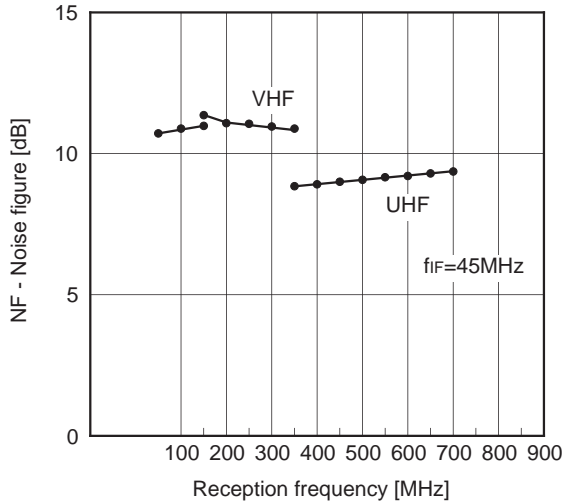

Reception frequency vs. +B drift

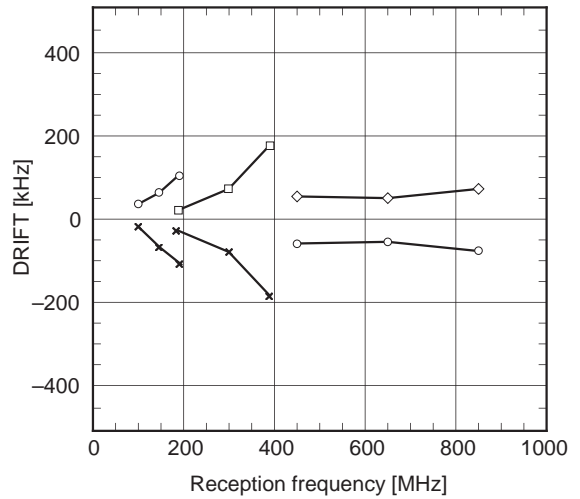

Reception frequency vs. Next adjacent cross modulation  
(untuned input, for asymmetrical output)

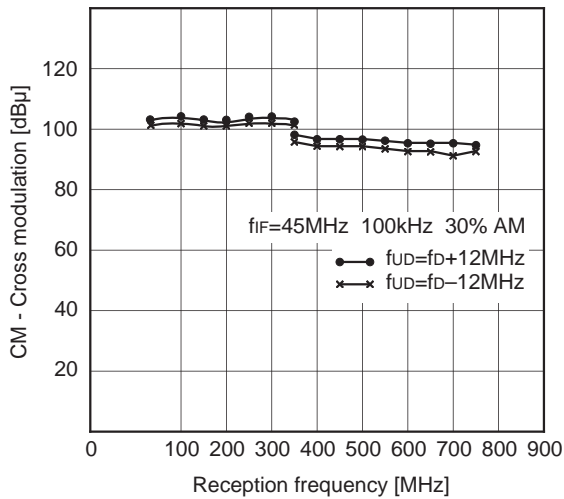

I/O characteristics (untuned input, for asymmetrical output)

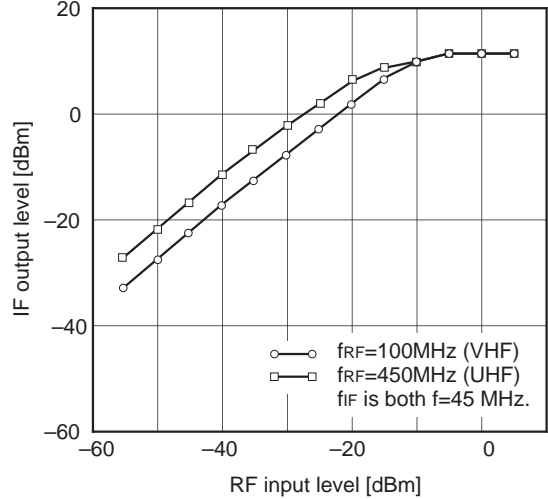

VHF Input Impedance

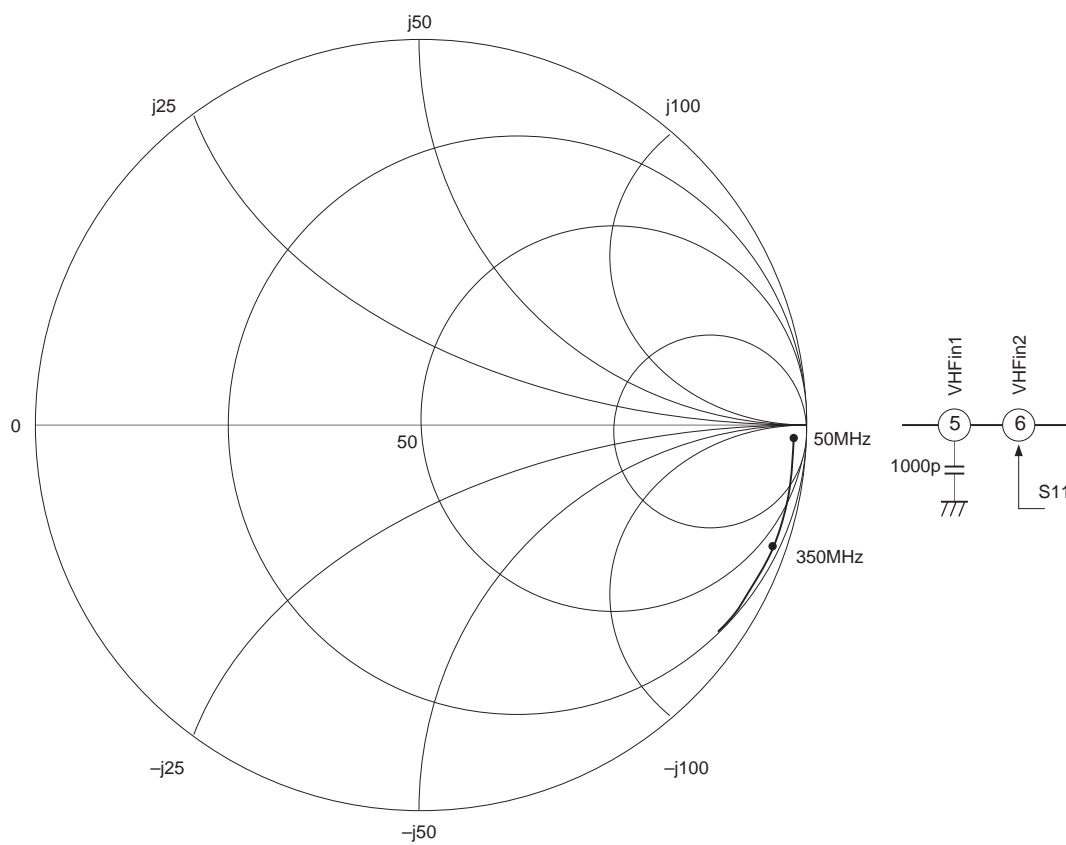

UHF Input Impedance

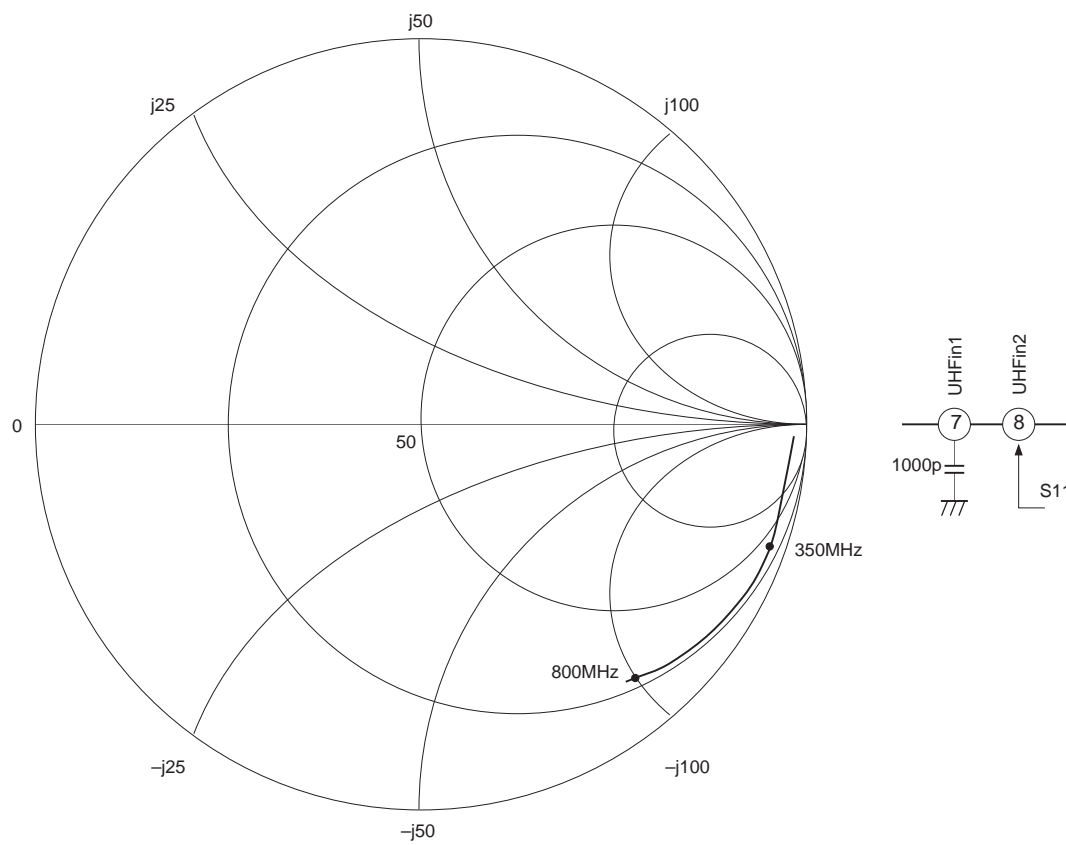

**IF Output Impedance (symmetrical output)**

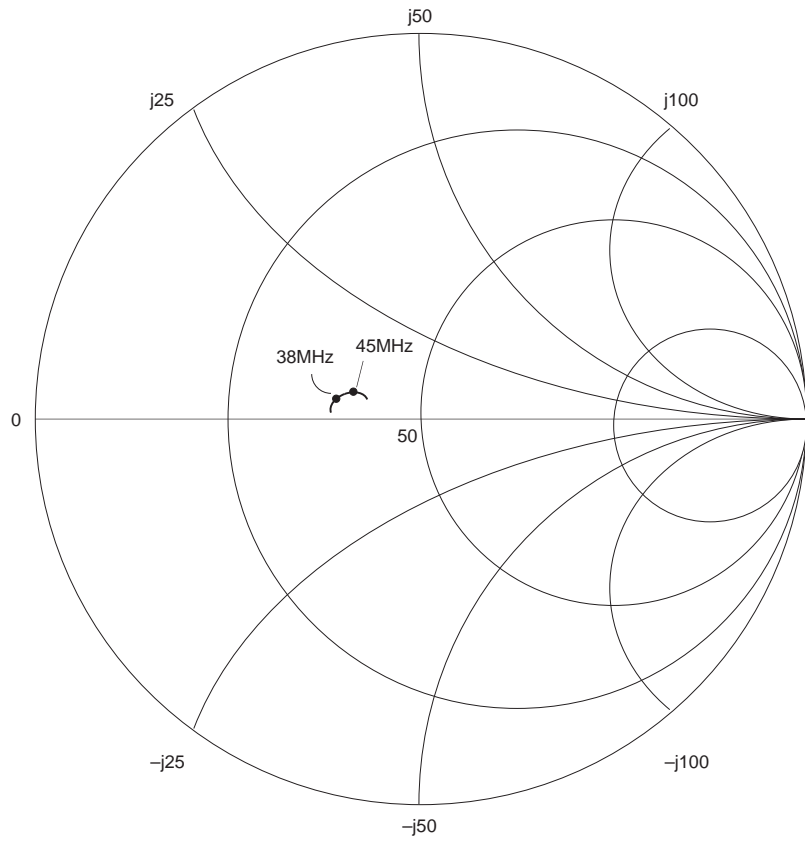

**IF Output Impedance (asymmetrical output)**

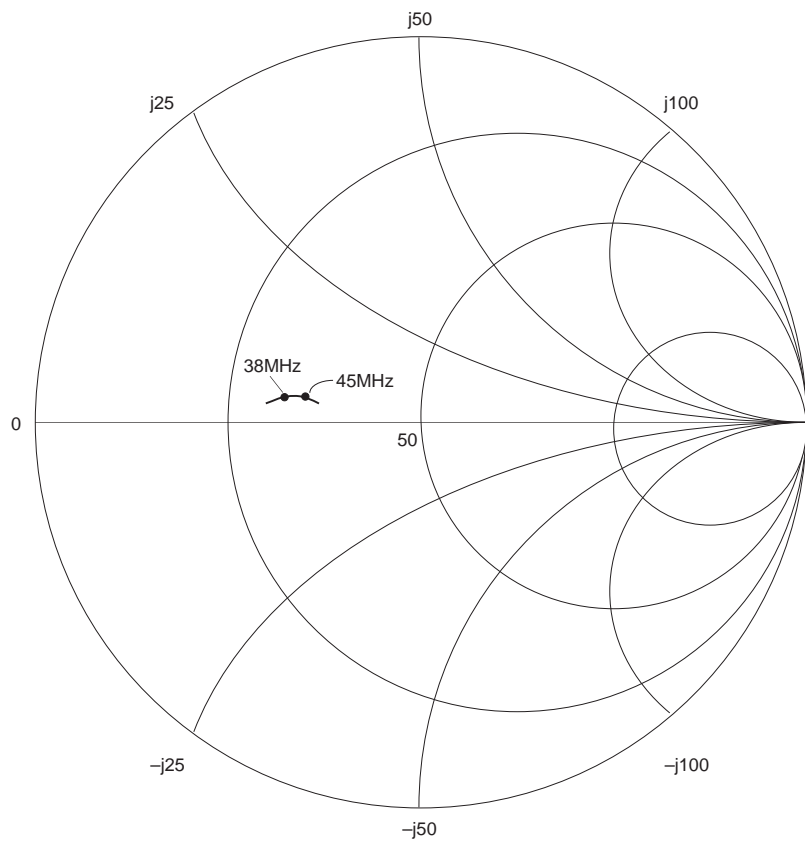

Package Outline Unit : mm

16PIN SSOP (PLASTIC)

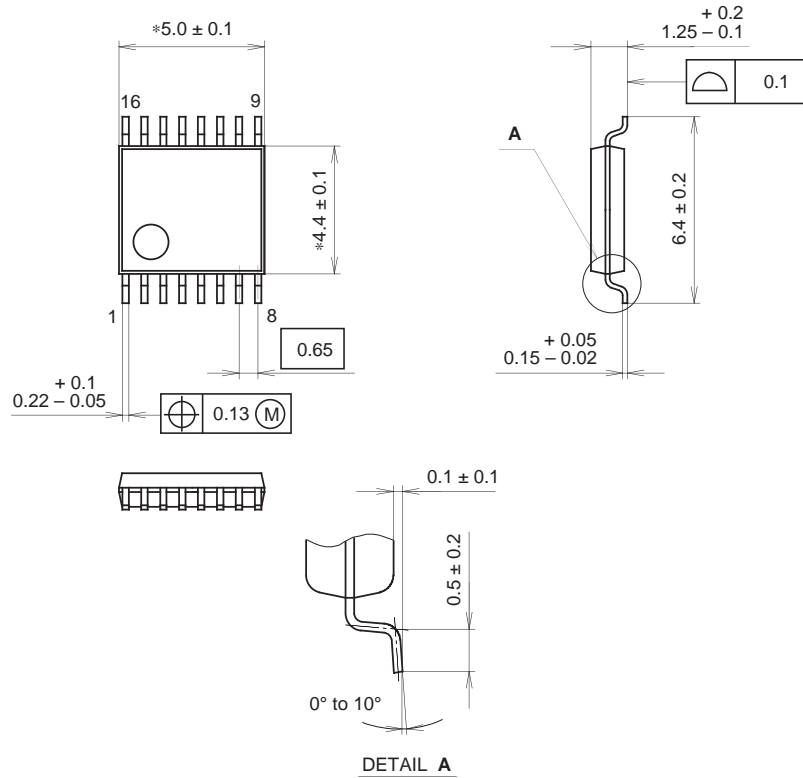

NOTE: Dimension "\*" does not include mold protrusion.

PACKAGE STRUCTURE

SONY CODE	SSOP-16P-L01
EIAJ CODE	SSOP016-P-0044
JEDEC CODE	_____

PACKAGE MATERIAL	EPOXY RESIN
LEAD TREATMENT	SOLDER / PALLADIUM PLATING
LEAD MATERIAL	42/COPPER ALLOY
PACKAGE MASS	0.1g