

The MRFIC Line

1.9 GHz GaAs Upconverter

Designed primarily for use in wireless Personal Communication Systems (PCS) applications such as Digital European Cordless Telephone (DECT), Japan's Personal Handy System (PHS) and the emerging North American systems. The MRFIC1813 is also applicable to 2.4 GHz ISM equipment. The device combines a balanced upmixer and a transmit exciter amplifier in a low-cost TSSOP-16 package. Minimal off-chip matching is required while allowing for maximum flexibility and efficiency. The mixer is optimized for low-side injection and provides more than 12 dB of conversion gain with over 0 dBm output at 1 dB gain compression. Image filtering is implemented off-chip to allow maximum flexibility. A CMOS compatible ENABLE pin allows standby operation where the current drain is less than 250 μ A.

Together with other devices from the MRFIC180X or the MRFIC240X series, this GaAs IC family offers the complete transmit and receive functions, less LO and filters, needed for a typical 1.8 GHz cordless telephone or 2.4 GHz ISM band equipment.

- Usable Frequency Range = 1.7 to 2.5 GHz
- 15 dB Typ IF to RF Conversion Gain
- 3 dBm Power Output Typ, 0 dBm Minimum at 1 dB Gain Compression
- Simple Off-chip Matching for Maximum Flexibility
- Low Power Consumption = 75 mW (Typ)
- Single Bias Supply = 2.7 to 4.5 Volts
- Low LO Power Requirement = - 5 dBm (Typ)
- Low Cost Surface Mount Plastic Package
- Order MRFIC1813R2 for Tape and Reel.
R2 Suffix = 2,500 Units per 16 mm, 13 inch Reel.
- Device Marking = M1813

MRFIC1813

1.9 GHz UPMIXER AND EXCITER AMPLIFIER

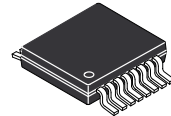

CASE 948C-03
(TSSOP-16)

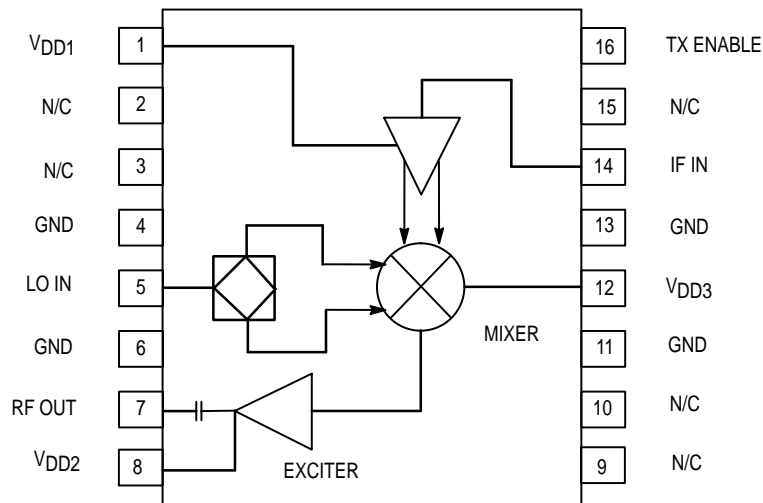

Pin Connections and Functional Block Diagram

MAXIMUM RATINGS ($T_A = 25^\circ\text{C}$ unless otherwise noted)

Ratings	Symbol	Limit	Unit
Supply Voltage	$V_{DD1}, V_{DD2}, V_{DD3}$	5.5	Vdc
IF Input Power	P_{IF}	3	dBm
LO Input Power	P_{LO}	3	dBm
Enable Voltage	TX ENABLE	5.5	Vdc
Storage Temperature Range	T_{stg}	- 65 to +150	$^\circ\text{C}$
Operating Ambient Temperature	T_A	- 30 to +85	$^\circ\text{C}$

RECOMMENDED OPERATING RANGES

Parameter	Symbol	Value	Unit
RF Output Frequency	f_{RF}	1.7 to 2.5	GHz
LO Input Frequency	f_{LO}	1.5 to 2.4	GHz
IF Input Frequency	f_{IF}	70 to 350	MHz
Supply Voltage	V_{DD}	2.7 to 4.5	Vdc
TX Enable Voltage, ON	TX ENABLE	2.7 to V_{DD}	Vdc
TX Enable Voltage, OFF	TX ENABLE	0 to 0.2	Vdc

ELECTRICAL CHARACTERISTICS ($V_{DD1,2,3}, TX\ ENABLE = 3\text{ V}, T_A = 25^\circ\text{C}, f_{LO} = 1.65\text{ GHz @ } -5\text{ dBm}, f_{IF} = 250\text{ MHz @ } -15\text{ dBm}$)

Characteristic	Min	Typ	Max	Unit
IF to RF Small Signal Conversion Gain ($P_{RF} = -35\text{ dBm}$)	12	15	—	dB
RF Output 1 dB Gain Compression	0	3	—	dBm
RF Output 3rd Order Intercept	—	11	—	dBm
LO Feedthrough to RF Port	—	-15	-10	dBm
Noise Figure	—	11	—	dB
Lower Sideband Output Power at RF Port	—	-10	-6	dBm
Supply Current TX Mode	—	25	35	mA
Supply Current Standby Mode ($TX\ ENABLE = 0\text{ V}, LO\ Off$)	—	100	250	μA
TX Enable Current	—	3	—	μA

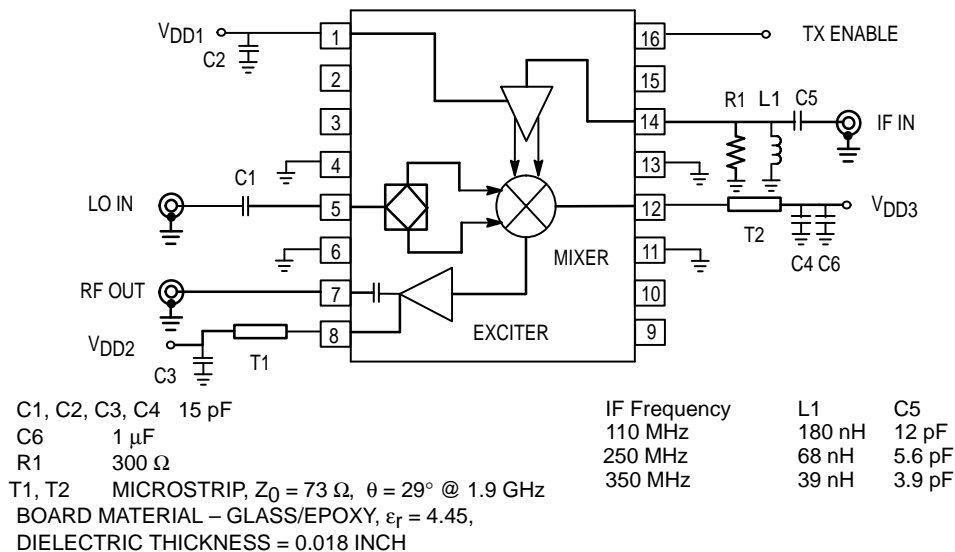

Figure 1. Applications Circuit Configuration

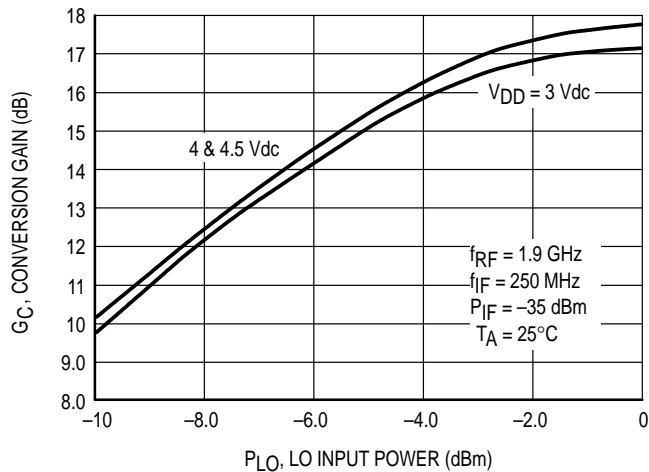

Figure 2. Conversion Gain versus LO Power

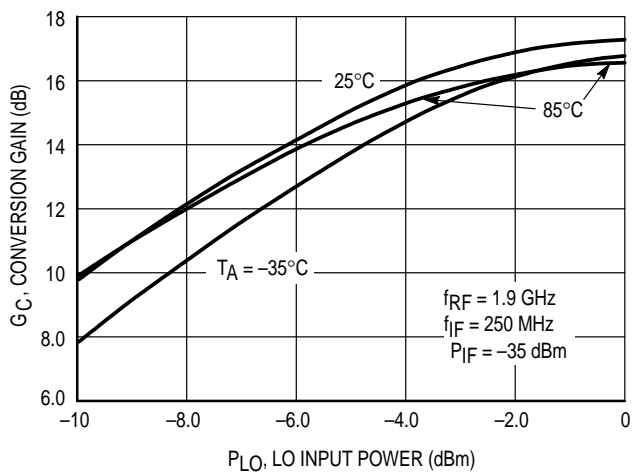

Figure 3. Conversion Gain versus LO Power

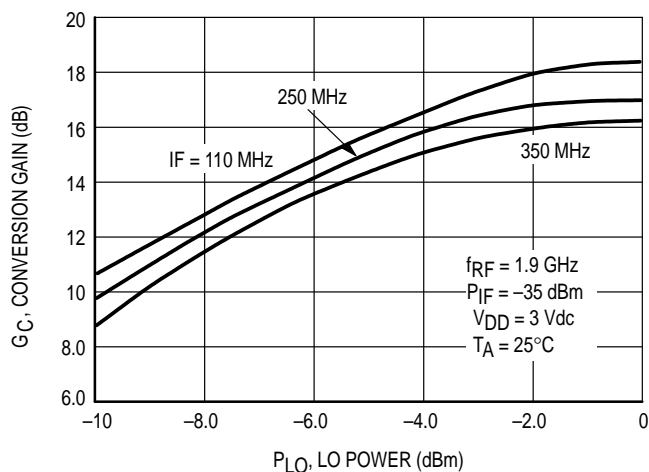

Figure 4. Conversion Gain versus LO Power

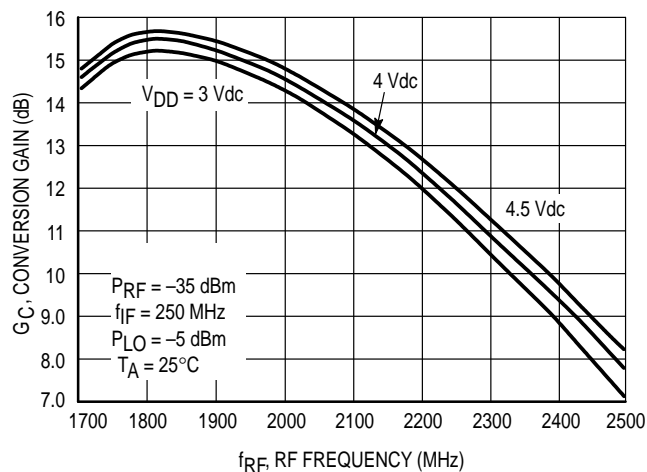

Figure 5. Conversion Gain versus RF Frequency

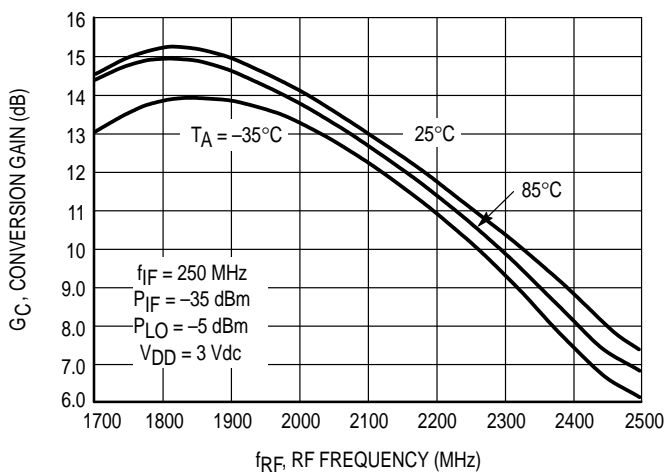

Figure 6. Conversion Gain versus RF Frequency

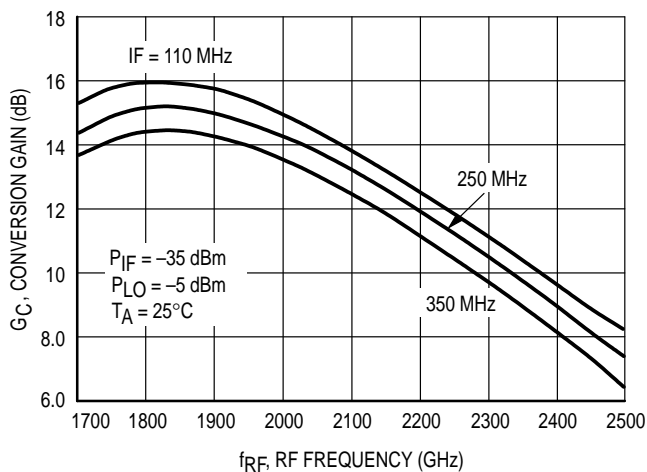

Figure 7. Conversion Gain versus RF Frequency

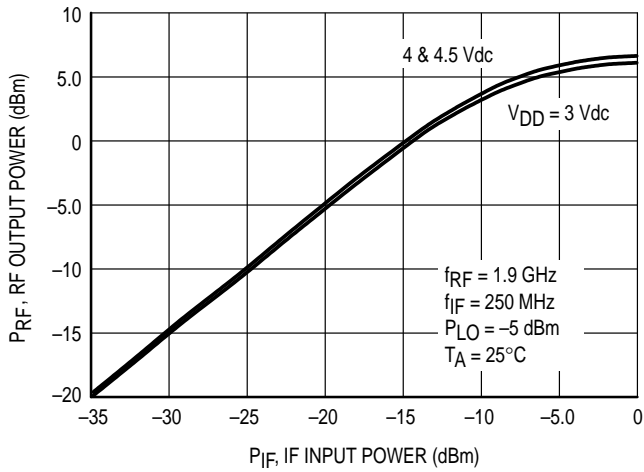

Figure 8. RF Output versus Input Power

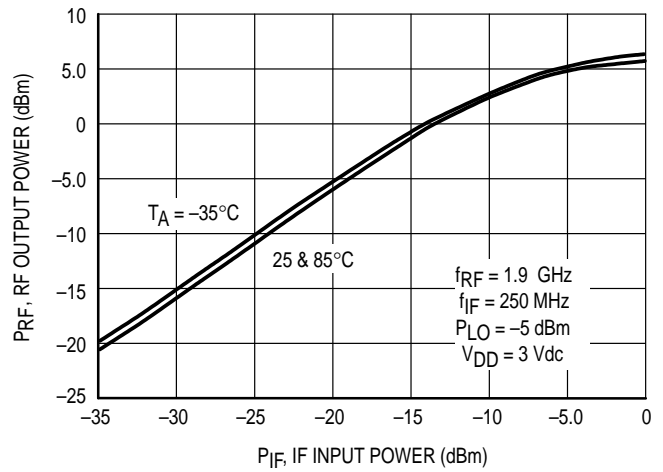

Figure 9. RF Output Power versus IF Input Power

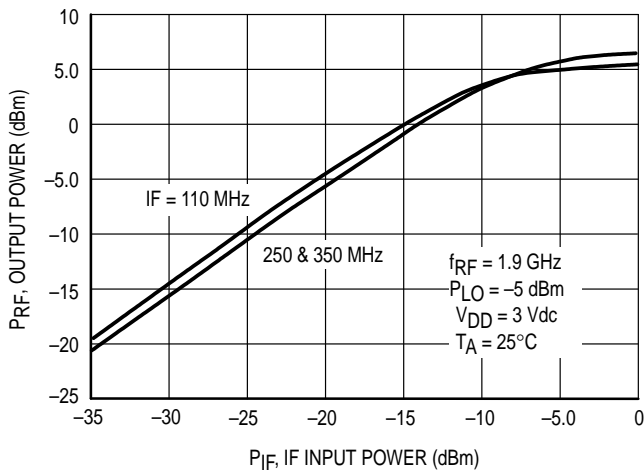

Figure 10. RF Output versus IF Input Power

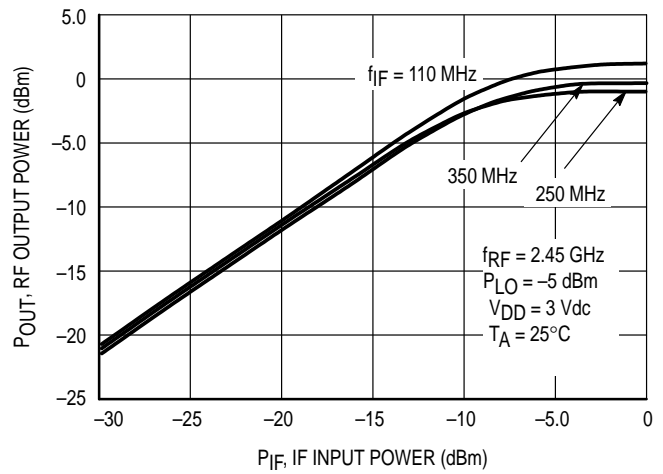

Figure 11. Output Power versus IF Input Power

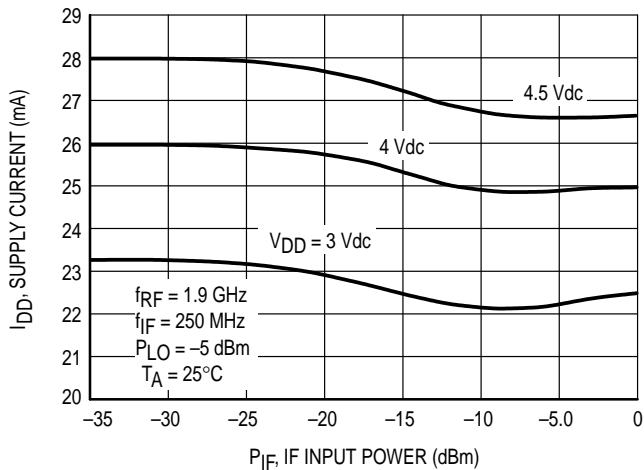

Figure 12. Supply Current versus IF Input Power

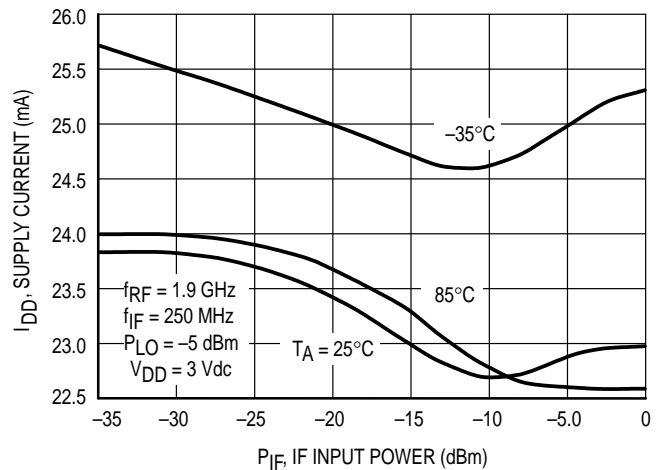

Figure 13. Supply Current versus IF Input Power

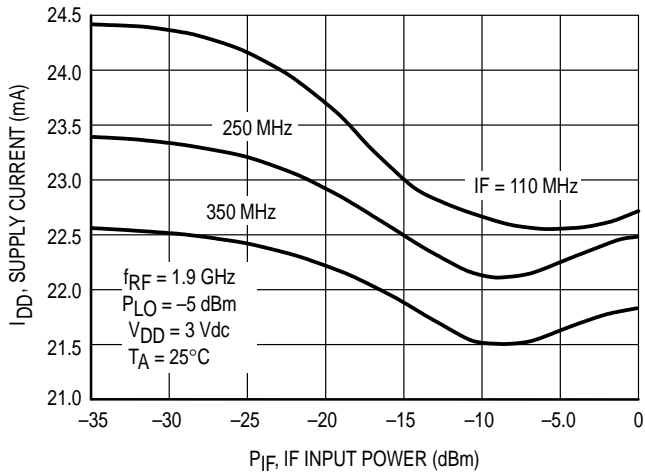

Figure 14. Supply Current versus IF Input Power

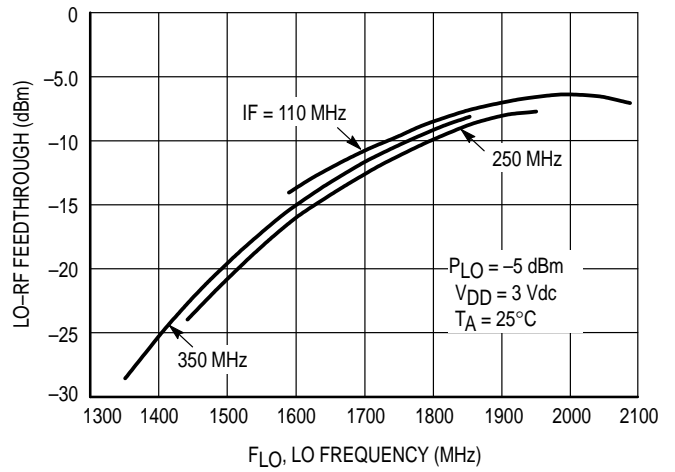

Figure 15. LO to RF Feedthrough versus LO Frequency

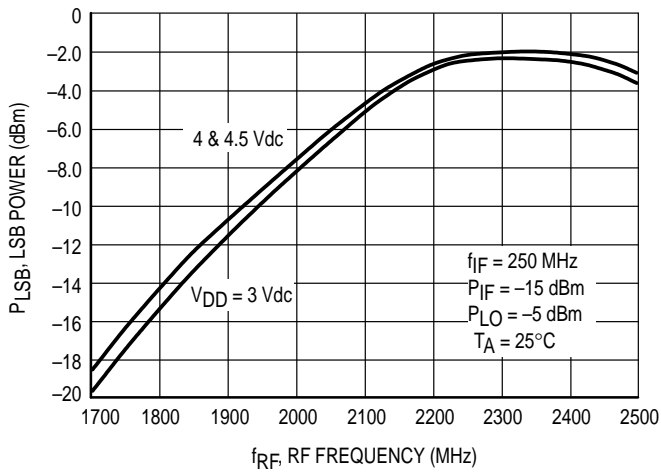

Figure 16. Lower Side Band Power versus RF Frequency

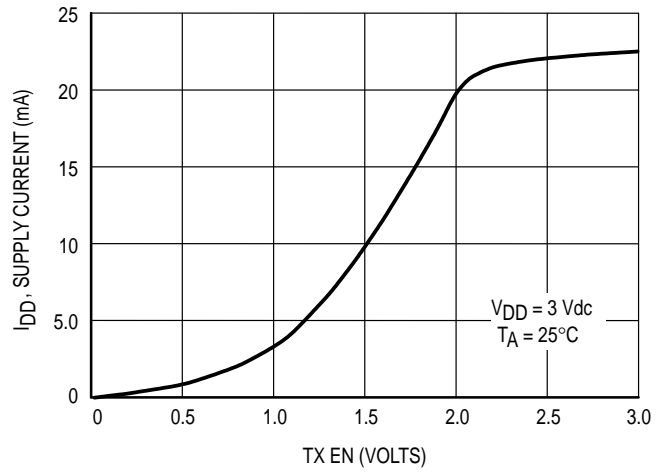

Figure 17. Supply Current versus Transmit Enable Voltage

f (MHz)	IF Input		LO Input		RF Output (1)	
	R	jX	R	jX	R	jX
70	8.3	-452.4				
100	7.3	-318.5				
150	7.1	-211.3				
200	6.6	-156.4				
250	6.5	-123.1				
300	6.1	-100.7				
350	5.7	-84.2				
1100			62.5	3.1		
1200			58.1	4.3		
1300			53.7	4.7		
1400			50.2	4.2		
1500			47.3	3.9		
1600			44.4	3.2		
1700			42.0	1.6	30.4	33.6
1800			40.6	0.5	42.6	16.9
1900			39.6	-0.7	49.1	2.3
2000			38.7	-2.2	40.6	14.2
2100			38.2	-3.6	33.8	17.7
2200			38.4	-5.1	33.3	15.7
2300			38.9	-6.5	32.9	13.7
2400			39.5	-7.8	29.6	13.2
2500					27.4	11.9

(1) Includes T1 shown in Figure 1.

**Table 1. Port Impedances versus Frequency
(VD1, VD2, VD3, TX EN = 3 Vdc)**

APPLICATIONS INFORMATION

DESIGN CONSIDERATIONS

The MRFIC1813 combines a single-balanced MESFET mixer with an exciter amplifier. It is usable for transmit frequencies from 1.7 to 2.5 GHz and IF frequencies from 70 to 350 MHz. The design is optimized for low-side local oscillator injection in heterodyne transmit applications.

Minimal off-chip matching is required while allowing for flexibility and performance optimization. An active balun is employed at the IF port which gives good balance down to at least 70 MHz. A passive splitter is used at the LO input to complete the single-balanced configuration.

CIRCUIT CONSIDERATIONS

Figure 1 shows the application circuit used to gather the data presented in the characterization curves. As shown in Table 1, the IF port impedance is very high. Three hundred ohms was chosen for R1 to shunt the IF port as a compromise of gain and bandwidth. A 50 Ω resistor can be used and L1 and C5 eliminated to provide a broadband match. The

conversion gain is reduced to about 8 dB. Microstrip inductors T1 and T2 combine with inductance internal to the device to form RF chokes. Some tuning of the RF output can be achieved with T1.

As with all RF devices, circuit layout is important. Controlled impedance lines should be used for all RF and IF interconnects. As shown in Figure 1, power supply bypassing should be used to avoid device instability. Ground vias should be included near all ground connections indicated in the schematic. Off-chip components should be mounted as close to the IC leads as possible.

EVALUATION BOARDS

Evaluation boards are available for RF Monolithic Integrated Circuits by adding a "TF" to the device type. For a complete list of currently available boards and one in development for newly introduced products, please contact your local Motorola Distributor or Sales Office.

PACKAGE DIMENSIONS

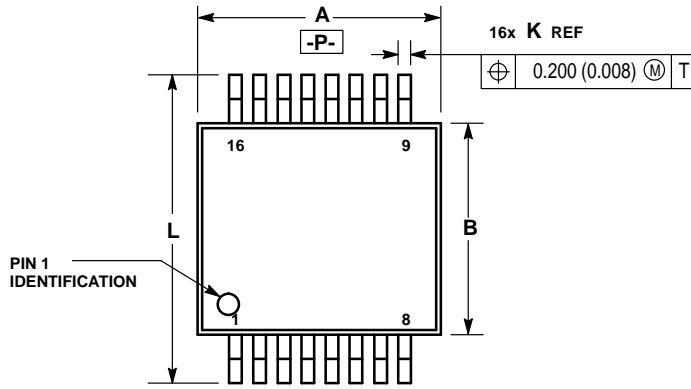

- NOTES:
1. DIMENSIONING AND TOLERANCING PER ANSI Y14.5M, 1982.
 2. CONTROLLING DIMENSION: MILLIMETER.
 3. DIMENSION A DOES NOT INCLUDE MOLD FLASH, PROTRUSIONS OR GATE BURRS. MOLD FLASH OR GATE BURRS SHALL NOT EXCEED 0.15 (0.006) PER SIDE.
 4. DIMENSION B DOES NOT INCLUDE INTERLEAD FLASH OR PROTRUSION. INTERLEAD FLASH OR PROTRUSION SHALL NOT EXCEED 0.25 (0.010) PER SIDE.
 5. DIMENSION K DOES NOT INCLUDE DAMBAR PROTRUSION. ALLOWABLE DAMBAR PROTRUSION SHALL BE 0.08 (0.003) TOTAL EXCESS OF THE K DIMENSION AT MAXIMUM MATERIAL CONDITION.
 6. TERMINAL NUMBERS ARE SHOWN FOR REFERENCE ONLY.
 7. DIMENSIONS A AND B ARE TO BE DETERMINED AT DATUM PLANE -U-.

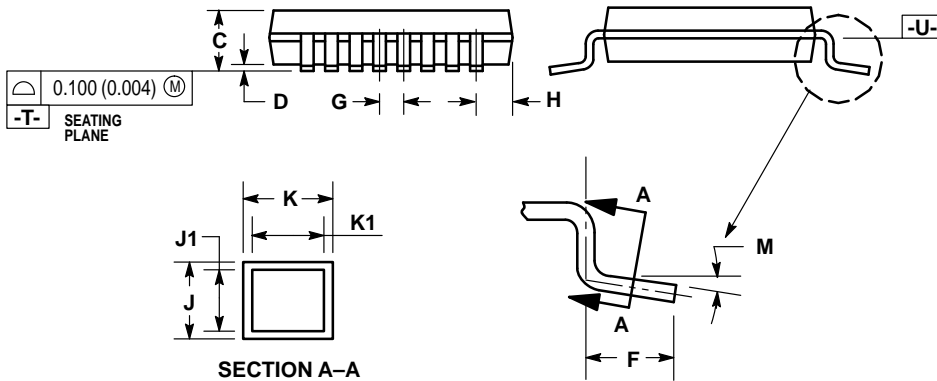

DIM	MILLIMETERS		INCHES	
	MIN	MAX	MIN	MAX
A	—	5.10	—	0.200
B	4.30	4.50	0.169	0.177
C	—	1.20	—	0.047
D	0.05	0.25	0.002	0.010
F	0.45	0.55	0.018	0.022
G	0.65 BSC		0.026 BSC	
H	0.22	0.23	0.009	0.010
J	0.09	0.24	0.004	0.009
J1	0.09	0.18	0.004	0.007
K	0.16	0.32	0.006	0.013
K1	0.16	0.26	0.006	0.010
L	6.30	6.50	0.248	0.256
M	0°	10°	0°	10°

CASE 948C-03
ISSUE B

Motorola reserves the right to make changes without further notice to any products herein. Motorola makes no warranty, representation or guarantee regarding the suitability of its products for any particular purpose, nor does Motorola assume any liability arising out of the application or use of any product or circuit, and specifically disclaims any and all liability, including without limitation consequential or incidental damages. "Typical" parameters which may be provided in Motorola data sheets and/or specifications can and do vary in different applications and actual performance may vary over time. All operating parameters, including "Typicals" must be validated for each customer application by customer's technical experts. Motorola does not convey any license under its patent rights nor the rights of others. Motorola products are not designed, intended, or authorized for use as components in systems intended for surgical implant into the body, or other applications intended to support or sustain life, or for any other application in which the failure of the Motorola product could create a situation where personal injury or death may occur. Should Buyer purchase or use Motorola products for any such unintended or unauthorized application, Buyer shall indemnify and hold Motorola and its officers, employees, subsidiaries, affiliates, and distributors harmless against all claims, costs, damages, and expenses, and reasonable attorney fees arising out of, directly or indirectly, any claim of personal injury or death associated with such unintended or unauthorized use, even if such claim alleges that Motorola was negligent regarding the design or manufacture of the part. Motorola and  are registered trademarks of Motorola, Inc. Motorola, Inc. is an Equal Opportunity/Affirmative Action Employer.

Mfax is a trademark of Motorola, Inc.

How to reach us:

USA/EUROPE/Locations Not Listed: Motorola Literature Distribution;
P.O. Box 5405, Denver, Colorado 80217. 303-675-2140 or 1-800-441-2447

JAPAN: Nippon Motorola Ltd.: SPD, Strategic Planning Office, 4-32-1,
Nishi-Gotanda, Shinagawa-ku, Tokyo 141, Japan. 81-3-5487-8488

Mfax™: RMFAX0@email.sps.mot.com – TOUCHTONE 602-244-6609
– US & Canada ONLY 1-800-774-1848

ASIA/PACIFIC: Motorola Semiconductors H.K. Ltd.; 8B Tai Ping Industrial Park,
51 Ting Kok Road, Tai Po, N.T., Hong Kong. 852-26629298

INTERNET: <http://motorola.com/sps>



MRFC1813/D