

M5237L,ML

3-TERMINAL ADJUSTABLE REGULATOR

DESCRIPTION

The M5237 is a semiconductor integrated circuit which is designed for variable output voltage regulator and is low power dissipation type with input-output voltage difference are quite low.

Housed in its 3-pin package are Reference voltage generator circuit, Differential amplifier and Drive circuit.

FEATURES

- Wide operating supply voltage range.
 $V_{IN} = 3.5V \sim 36V$. $V_O = 1.5V \sim 33V$
- The input-output voltage differences can be small moved by the external PNP transistors.
 $(T_R: V_{CE(sat)} \text{ state})$
 $V_{1-O(min)} \cong 0.2V$
- The output voltage can be freely adjusted by the external resistors.
- Built in Over-current protection circuit (Drooping fold-back unit), ASO protection circuit and Thermal protection circuit.
- Its possible Taping (Automatic insert) and Lead forming.

APPLICATION

Car stereos, radio cassettes, portable stereos, and other general usage electronic power supplies

RECOMMENDED OPERATING CONDITIONS

Supply voltage range $V_{IN} = 3.5V \sim 30V$
 Output voltage range $V_O = 1.5V \sim 25V$

PIN CONFIGURATION

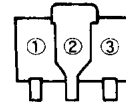
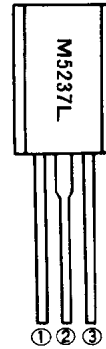

Outline SOT-89(ML)

Outline TO-92L(L)

ELECTRODE CONNECTIONS

- ① INPUT
- ② GROUND
- ③ OUTPUT

BLOCK DIAGRAM

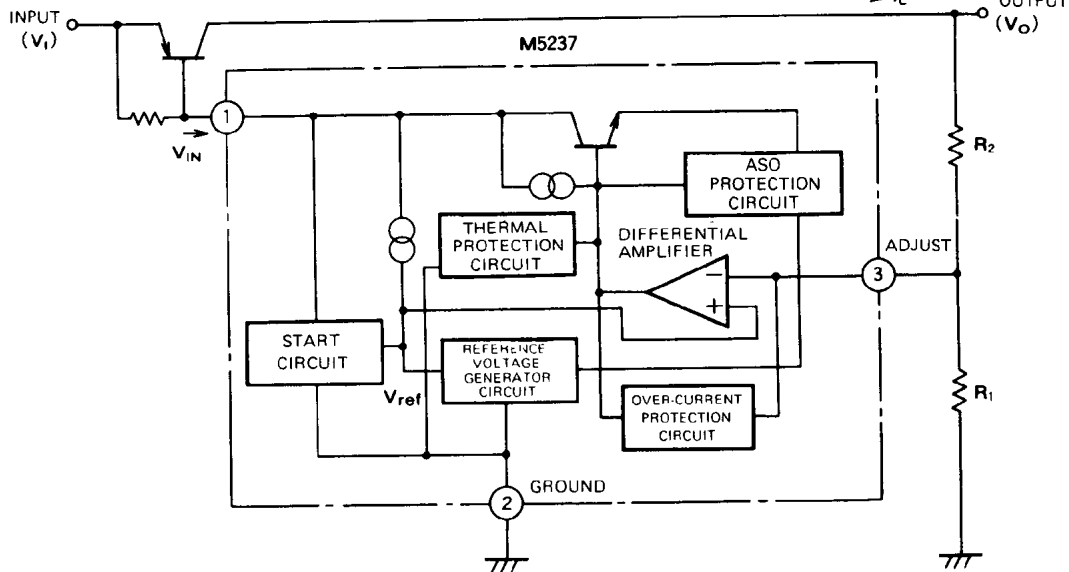

3-TERMINAL ADJUSTABLE REGULATOR

ABSOLUTE MAXIMUM RATINGS (Ta = 25°C, unless otherwise noted)

Symbol	Parameter	Ratings	Unit
V _{IN}	Input voltage	36	V
I _D	Drive current	30	mA
V _I - V _O	Input/output voltage difference	30	V
P _d	Internal power dissipation	900(L)/500(ML)	mW
T _{opr}	Operating ambient temperature	-20 ~ +75	°C
T _{stg}	Storage temperature	-55 ~ +150	°C

ELECTRICAL CHARACTERISTICS

(measurement circuit (a) is used with T_a = 25°C, V_I = 15V, V_O = 12V, I_L = 200mA, C_{REF} = 1μF, R₁ = 4.3kΩ)

Symbol	Parameter	Test condition	Limits			Unit
			Min	Typ	Max	
V _{IN}	Input voltage	(between Pin 1 and Pin 2)	3.5		36	V
V _O	Output voltage	R ₂ ≅ 0.82kΩ ~ 108kΩ	1.5		33	V
V _I - V _O	Minimum input/output voltage difference			0.2		V
V _{REF}	Reference voltage	(between Pin 2 and Pin 3)	1.20	1.26	1.32	V
Reg-in	Input voltage regulation	V _I = 15 ~ 20V		0.02	0.1	%/V
Reg-L	Loading voltage regulation	I _L = 10 ~ 200mA		0.02	0.1	%
I _B	Bias current	I _L = 0 (disregarding the current in resistors R ₁ , R ₂)		1.7	3.0	mA
TC _{VO}	Output voltage thermal coefficient	T _a = 0 ~ 75°C		0.02		%/°C
RR	Ripple rejection	f = 120Hz (measured with circuit (b))		68		dB
V _{NO}	Output noise voltage	f = 20Hz ~ 100kHz		25		μVrms

TEST CIRCUIT

(a) Standard test circuit

$$V_O = V_{REF} \left(1 + \frac{R_2}{R_1}\right) \cong 1.26 \times \left(1 + \frac{R_2}{4.3}\right) \text{ (V)}$$

$$R_2 = R_1 \left(\frac{V_O}{V_{REF}} - 1\right) \cong 4.3 \times \left(\frac{V_O}{1.26} - 1\right) \text{ (k}\Omega\text{)}$$

$$(R_1 = 4.3\text{k}\Omega, V_{REF} \cong 1.26\text{V})$$

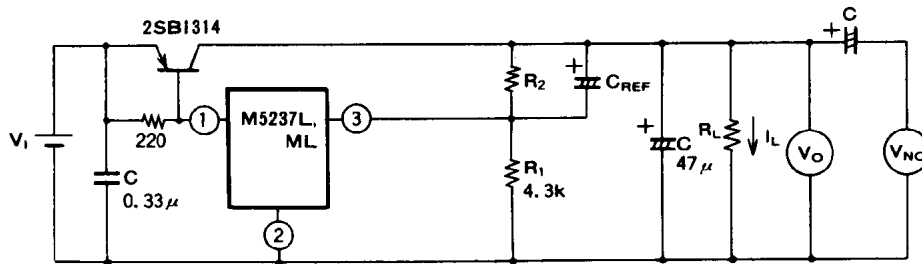

(b) Ripple rejection test circuit

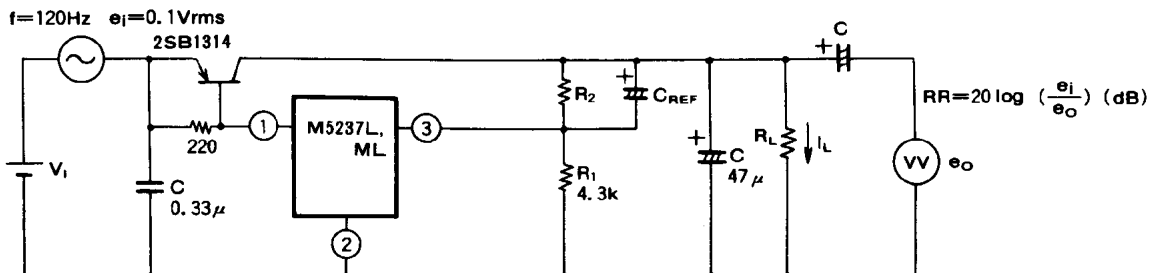

3-TERMINAL ADJUSTABLE REGULATOR

TYPICAL CHARACTERISTICS

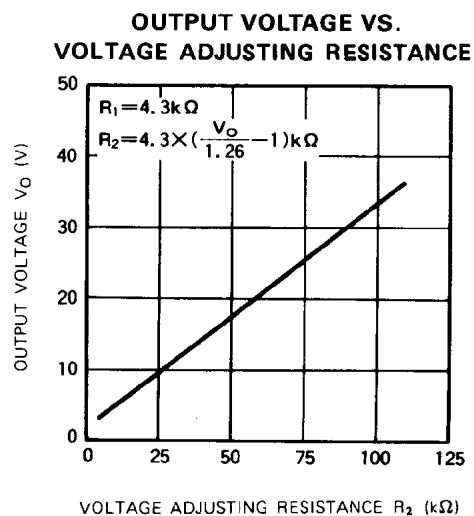
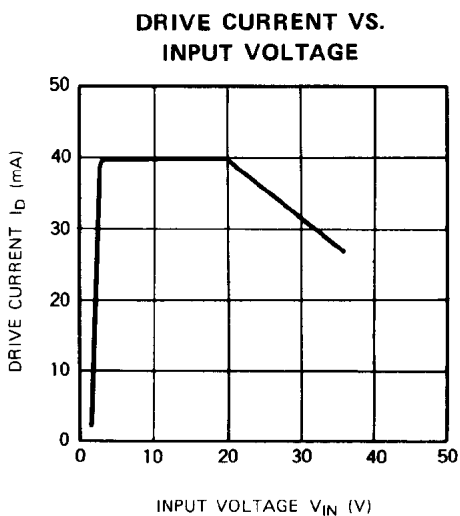
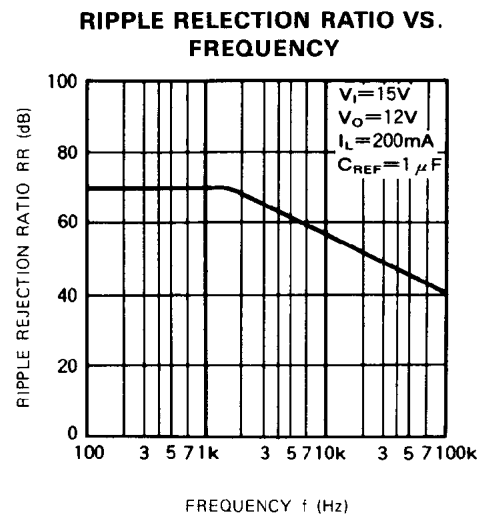
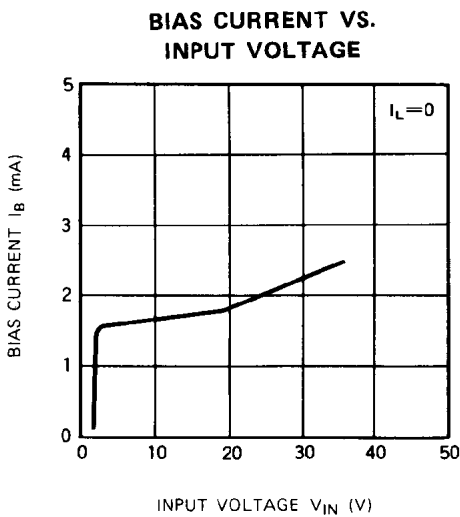
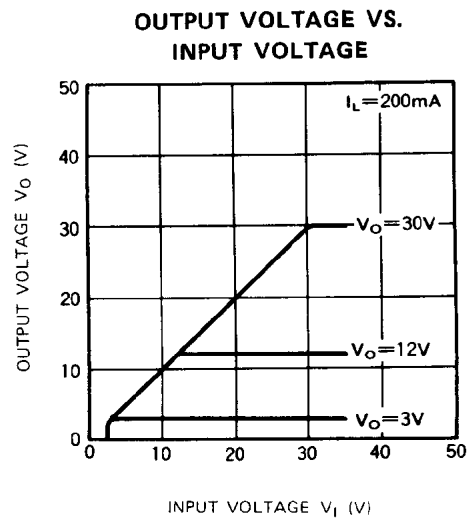
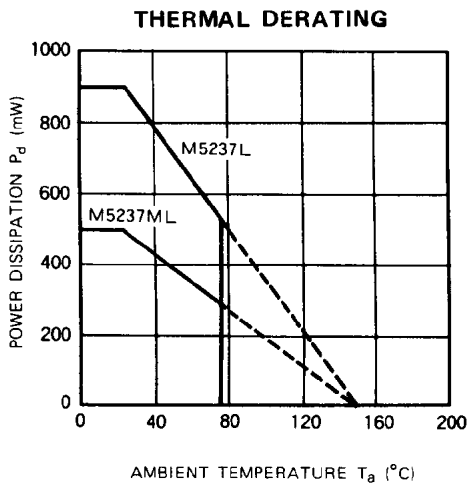

3-TERMINAL ADJUSTABLE REGULATOR

APPLICATION CIRCUIT

1. Standard application circuit

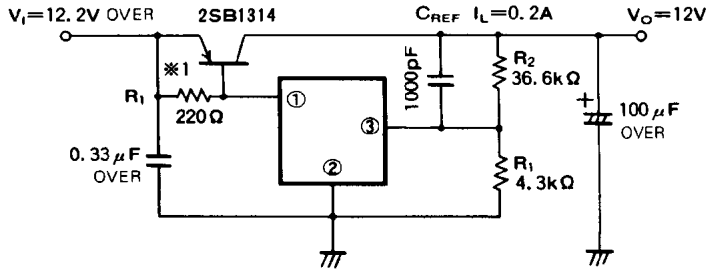

$$V_O = V_{REF} \times \left(1 + \frac{R_2}{R_1}\right) V$$

$$V_{REF} = 1.26V$$

※1. $R_1 = 180 \sim 220\Omega$

Note: Please use the capacitor not to depend on the ambient temperature.

2. Maximum drive current controller application circuit

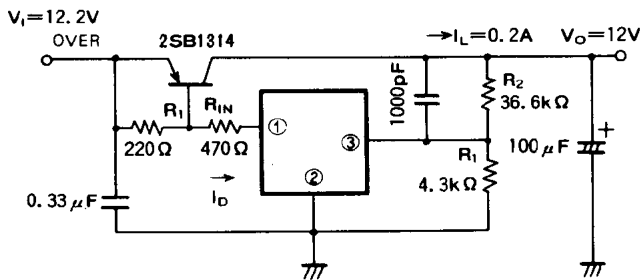

Fig. 1 MAXIMUM DRIVE CURRENT

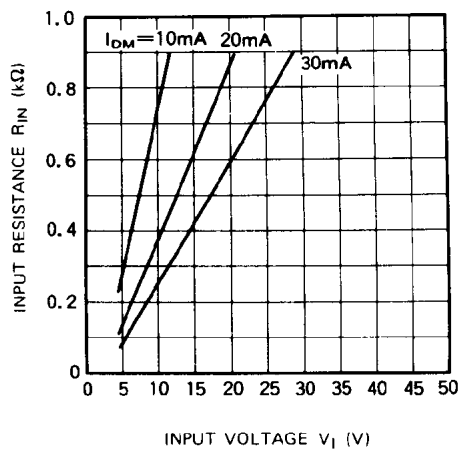
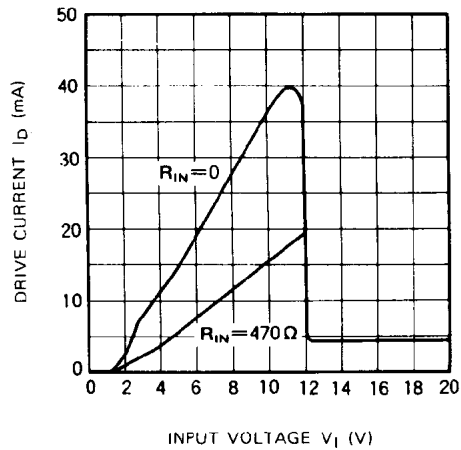
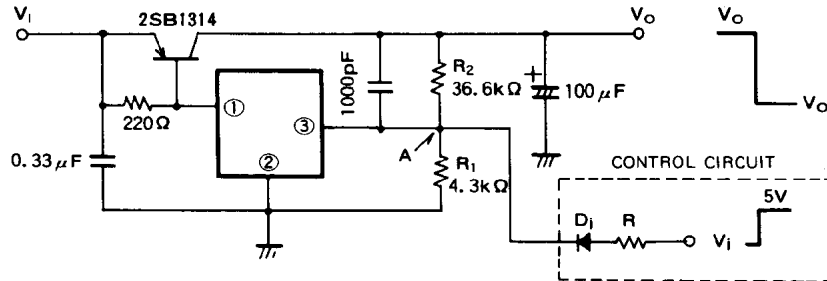

Fig. 2 DRIVE CURRENT VS. INPUT VOLTAGE



3-TERMINAL ADJUSTABLE REGULATOR

3. Output voltage ON/OFF controller



Set control circuit resistor R so that voltage of point A is more than 1.5V and less than 5V.

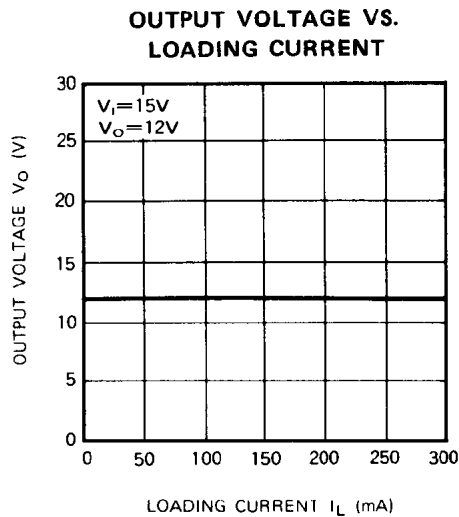
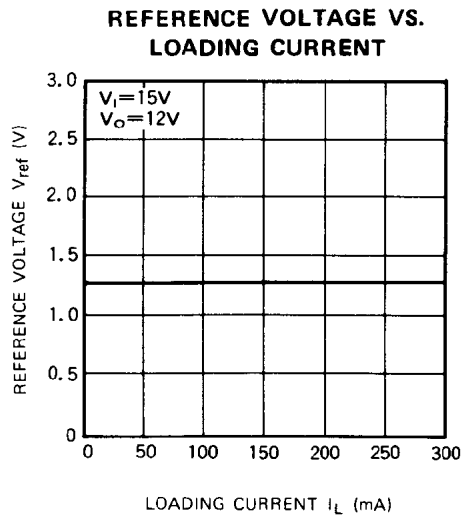
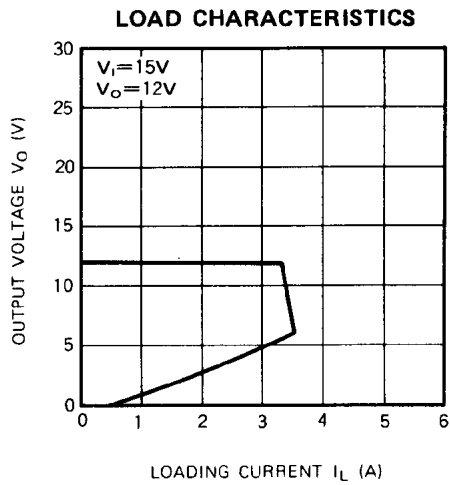

3-TERMINAL ADJUSTABLE REGULATOR

REFERENCE VOLTAGE VS. AMBIENT TEMPERATURE

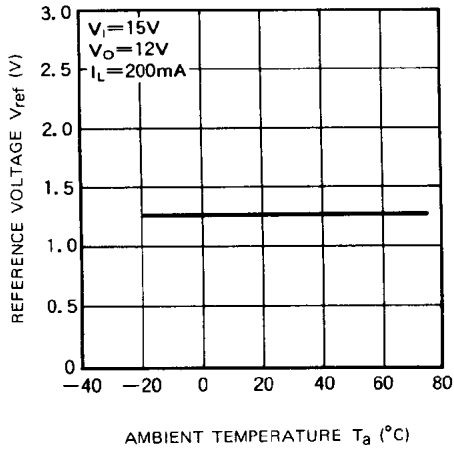

OUTPUT VOLTAGE VS. AMBIENT TEMPERATURE

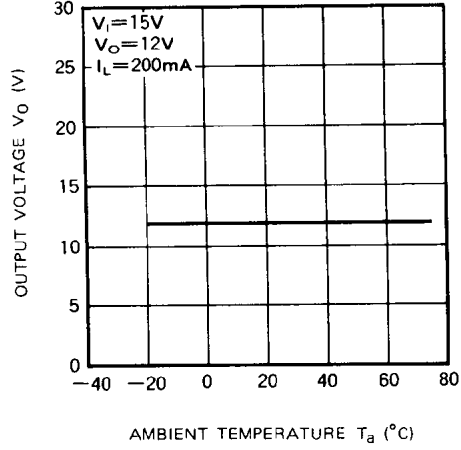

OUTPUT NOISE VOLTAGE VS. AMBIENT TEMPERATURE

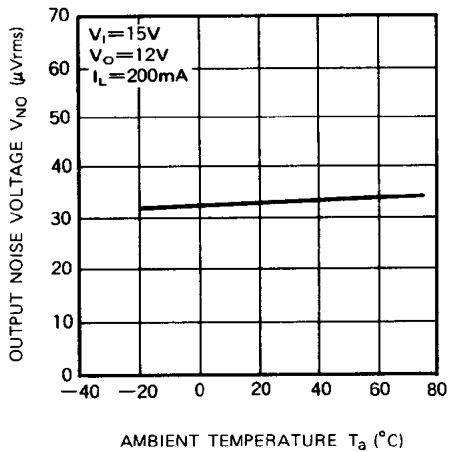

DRIVE CURRENT VS. AMBIENT TEMPERATURE

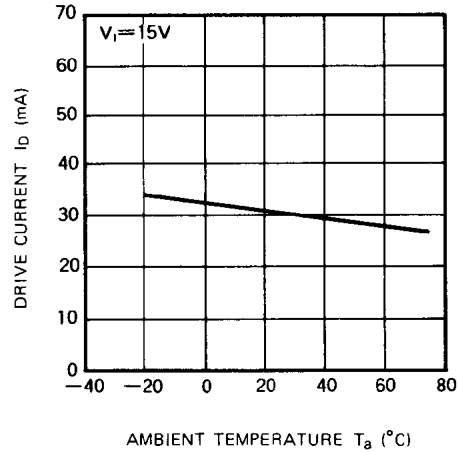

RIPPLE REJECTION RATIO VS. AMBIENT TEMPERATURE

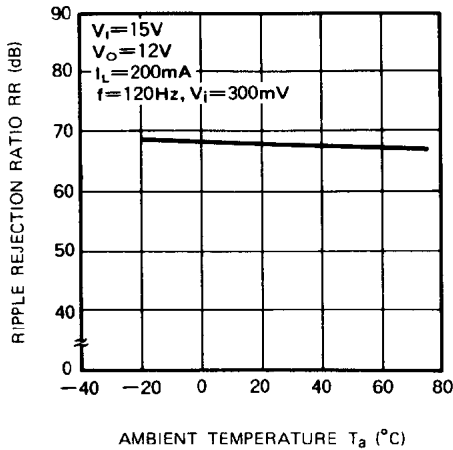

BIAS CURRENT VS. AMBIENT TEMPERATURE

