

FAIRCHILD

A Schlumberger Company

J-39-09

IRF610-613
MTP2N18/2N20
N-Channel Power MOSFETs,
3.5 A, 150-200 V
 Power And Discrete Division

Description

These devices are n-channel, enhancement mode, power MOSFETs designed especially for high speed applications, such as switching power supplies, converters, AC and DC motor controls, relay and solenoid drivers and other pulse circuits.

- Low $R_{DS(on)}$
- V_{GS} Rated at ± 20 V
- Silicon Gate for Fast Switching Speeds
- I_{DSS} , $V_{DS(on)}$, Specified at Elevated Temperature
- Rugged
- Low Drive Requirements
- Ease of Paralleling

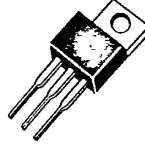
TO-220AB

1500010F

IRF610
 IRF611
 IRF612
 IRF613
 MTP2N18
 MTP2N20

Maximum Ratings

Symbol	Characteristic	Rating IRF610/612 MTP2N20	Rating MTP2N18	Rating IRF611/613	Unit
V_{DSS}	Drain to Source Voltage ¹	200	180	150	V
V_{DGR}	Drain to Gate Voltage ¹ $R_{GS} = 20 \text{ k}\Omega$	200	180	150	V
V_{GS}	Gate to Source Voltage	± 20	± 20	± 20	V
T_J , T_{stg}	Operating Junction and Storage Temperatures	-55 to +150	-55 to +150	-55 to +150	$^{\circ}\text{C}$
T_L	Maximum Lead Temperature for Soldering Purposes, 1/8" From Case for 5 s	275	275	275	$^{\circ}\text{C}$

Maximum On-State Characteristics

		IRF610/611	MTP2N18/20	IRF612/613	
$R_{DS(on)}$	Static Drain-to-Source On Resistance	1.5	1.8	2.4	Ω
I_D	Drain Current Continuous at $T_C = 25^{\circ}\text{C}$ Continuous at $T_C = 100^{\circ}\text{C}$ Pulsed	2.5	3.25	2.0	A
		1.5	2.25	1.25	
		10	9.0	8.0	

Maximum Thermal Characteristics

$R_{\theta JC}$	Thermal Resistance, Junction to Case	6.4	2.5	6.4	$^{\circ}\text{C}/\text{W}$
$R_{\theta JA}$	Thermal Resistance, Junction to Ambient	80	80	80	$^{\circ}\text{C}/\text{W}$
P_D	Total Power Dissipation at $T_C = 25^{\circ}\text{C}$	20	50	20	W

Notes

For information concerning connection diagram and package outline, refer to Section 7.

IRF610-613

MTP2N18/2N20

T-39.09

Electrical Characteristics ($T_C = 25^\circ\text{C}$ unless otherwise noted)

Symbol	Characteristic	Min	Max	Unit	Test Conditions
Off Characteristics					
$V_{(BR)DSS}$	Drain Source Breakdown Voltage ¹			V	$V_{GS} = 0\text{ V}$, $I_D = 250\ \mu\text{A}$
	IRF610/612/MTP2N20	200			
	MTP2N18	180			
	IRF611/613	150			
I_{DSS}	Zero Gate Voltage Drain Current		250	μA	$V_{DS} = \text{Rated } V_{DSS}$, $V_{GS} = 0\text{ V}$
			1000	μA	$V_{DS} = 0.8 \times \text{Rated } V_{DSS}$, $V_{GS} = 0\text{ V}$, $T_C = 125^\circ\text{C}$
I_{GSS}	Gate-Body Leakage Current		± 500	nA	$V_{GS} = \pm 20\text{ V}$, $V_{DS} = 0\text{ V}$
On Characteristics					
$V_{GS(th)}$	Gate Threshold Voltage			V	$I_D = 250\ \mu\text{A}$, $V_{DS} = V_{GS}$
	IRF610-613	2.0	4.0		
	MTP2N18/20	2.0	4.5		
$R_{DS(on)}$	Static Drain-Source On-Resistance ²			Ω	$V_{GS} = 10\text{ V}$, $I_D = 1.25\text{ A}$
	IRF610/611		1.5		
	IRF612/613		2.4		
	MTP2N18/20		1.8		
$V_{DS(on)}$	Drain-Source On-Voltage ²		4.4	V	$V_{GS} = 10\text{ V}$; $I_D = 2.0\text{ A}$
	MTP2N18/2N20		3.6	V	$V_{GS} = 10\text{ V}$; $I_D = 1.0\text{ A}$; $T_C = 100^\circ\text{C}$
g_{fs}	Forward Transconductance	0.8		S (Ω)	$V_{DS} = 10\text{ V}$, $I_D = 1.25\text{ A}$
Dynamic Characteristics					
C_{iss}	Input Capacitance		200	pF	$V_{DS} = 25\text{ V}$, $V_{GS} = 0\text{ V}$ $f = 1.0\text{ MHz}$
C_{oss}	Output Capacitance		80	pF	
C_{rss}	Reverse Transfer Capacitance		25	pF	
Switching Characteristics ($T_C = 25^\circ\text{C}$, Figures 11, 12) ³					
$t_{d(on)}$	Turn-On Delay Time		15	ns	$V_{DD} = 50\text{ V}$, $I_D = 1.25\text{ A}$ $V_{GS} = 10\text{ V}$, $R_{GEN} = 50\ \Omega$ $R_{GS} = 50\ \Omega$
t_r	Rise Time		25	ns	
$t_{d(off)}$	Turn-Off Delay Time		15	ns	
t_f	Fall Time		15	ns	
Q_g	Total Gate Charge		7.5	nC	$V_{GS} = 10\text{ V}$, $I_D = 3.0\text{ A}$ $V_{DD} = 45\text{ V}$

IRF610-613
MTP2N18/2N20 T-39.09

Electrical Characteristics (Cont.) ($T_C = 25^\circ\text{C}$ unless otherwise noted)

Symbol	Characteristic	Typ	Max	Unit	Test Conditions
Source-Drain Diode Characteristics					
V_{SD}	Diode Forward Voltage IRF610/611		2.0	V	$I_S = 2.5 \text{ A}; V_{GS} = 0 \text{ V}$
	IRF612/613		1.8	V	$I_S = 2.0 \text{ A}; V_{GS} = 0 \text{ V}$
t_{rr}	Reverse Recovery Time	290		ns	$I_S = 2.5 \text{ A}; di_S/dt = 25 \text{ A}/\mu\text{S}$

Notes

- $T_J = +25^\circ\text{C}$ to $+150^\circ\text{C}$
- Pulse test: Pulse width $\leq 80 \mu\text{s}$, Duty cycle $\leq 1\%$
- Switching time measurements performed on LEM TR-58 test equipment.

Typical Performance Curves

Figure 1 Output Characteristics

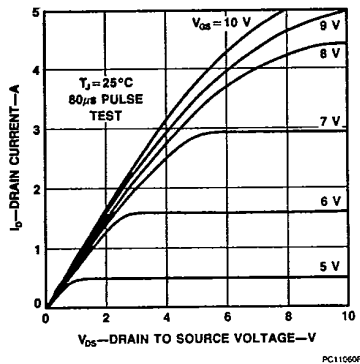

Figure 2 Static Drain to Source Resistance vs Drain Current

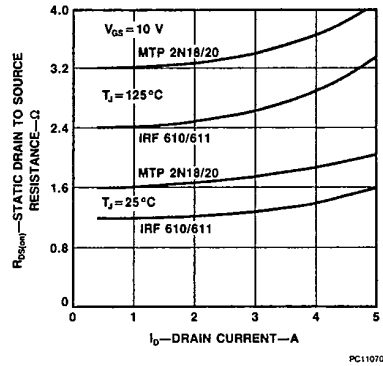

Figure 3 Transfer Characteristics

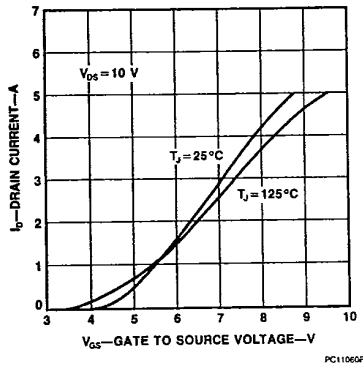
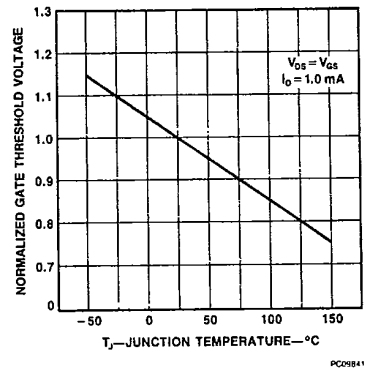

Figure 4 Temperature Variation of Gate to Source Threshold Voltage



IRF610-613

MTP2N18/2N20

T. 39.09

Typical Performance Curves (Cont.)

Figure 5 Capacitance vs Drain to Source Voltage

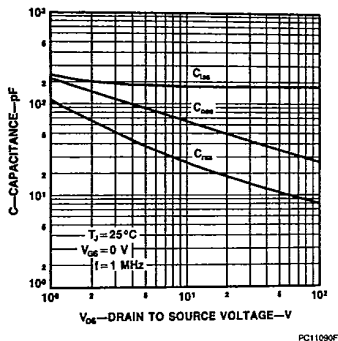

Figure 6 Gate to Source Voltage vs Total Gate Charge

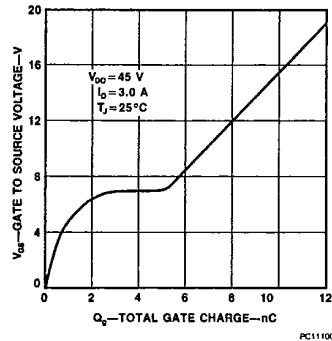

Figure 7 Forward Biased Safe Operating Area for MTP2N18/2N20

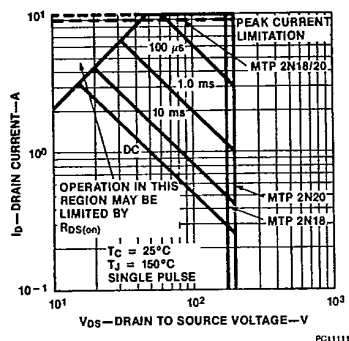

Figure 8 Transient Thermal Resistance vs Time for MTP2N18/2N20

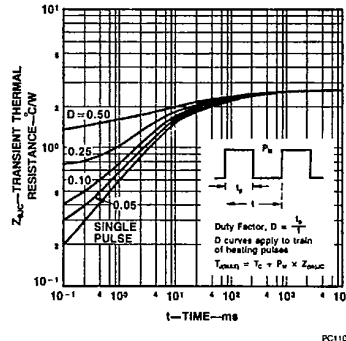

Figure 9 Forward Biased Safe Operating Area for IRF610-613

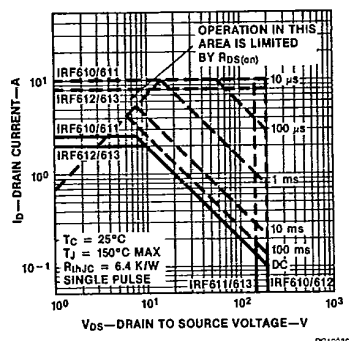
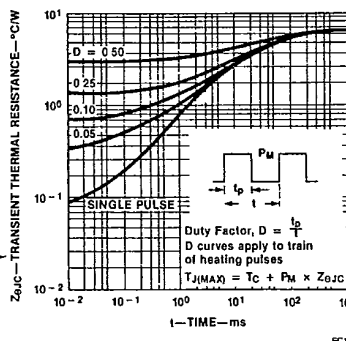

Figure 10 Transient Thermal Resistance for IRF610-613



IRF610-613
MTP2N18/2N20

F39-09

Typical Electrical Characteristics
Figure 11 Switching Test Circuit

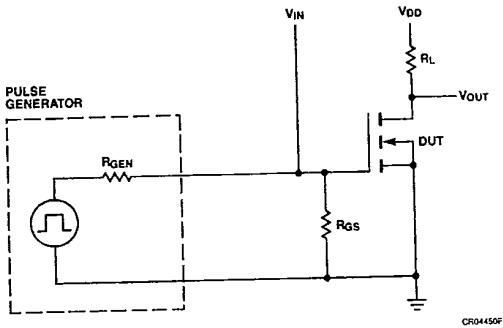

Figure 12 Switching Waveforms

