

HD74LS74A • Dual D-type Positive Edge-triggered Flip-Flops (with Preset and Clear)

FUNCTION TABLE

Inputs				Outputs	
Preset	Clear	Clock	D	Q	\bar{Q}
L	H	X	X	H	L
H	L	X	X	L	H
L	L	X	X	H*	H*
H	H	↑	H	H	L
H	H	↑	L	L	H
H	H	L	X	Q_0	\bar{Q}_0

Notes) H; high level, L; low level, X; irrelevant
 ↑; transition from low to high level
 Q_0 ; level of Q before the indicated steady-state conditions were established.
 \bar{Q}_0 ; complement of Q_0 or level of \bar{Q} before the indicated steady-state input conditions were established.
 *: This configuration is nonstable, that is, it will not persist when preset and clear inputs return to their inactive (high) level.

TIMING DEFINITION

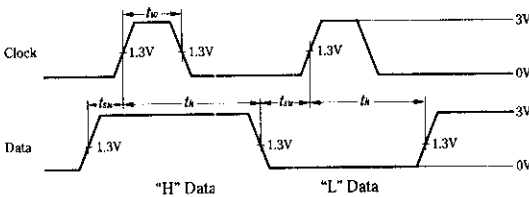

PIN ARRANGEMENT

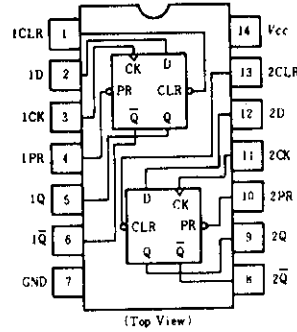

RECOMMENDED OPERATING CONDITIONS

Item	Symbol	min	typ	max	Unit
Clock frequency	f_{clock}	0	—	25	MHz
Pulse width	Clock High	25	—	—	ns
	Clear/Preset	25	—	—	
Setup time	"H" Data	20↑	—	—	ns
	"L" Data	20↑	—	—	
Hold time	t_h	5↑	—	—	ns

Note) ↑; The arrow indicates the rising edge.

ELECTRICAL CHARACTERISTICS ($T_a = -20 \sim +75^\circ\text{C}$)

Item	Symbol	Test Conditions	min	typ*	max	Unit		
Input voltage	V_{IH}		2.0	—	—	V		
	V_{IL}		—	—	0.8	V		
	V_{OH}	$V_{CC} = 4.75\text{V}, V_{IH} = 2\text{V}, V_{IL} = 0.8\text{V}, I_{OH} = -400\mu\text{A}$	2.7	—	—	V		
Output voltage	V_{OL}	$V_{CC} = 4.75\text{V}, V_{IL} = 0.8\text{V}, V_{IH} = 2\text{V}$	—	—	0.5	V		
		$I_{OL} = 8\text{mA}$	—	—	0.4			
Input current	D	I_{IH}	$V_{CC} = 5.25\text{V}, V_I = 2.7\text{V}$	—	—	20	μA	
				Clear	—	—		40
				Preset	—	—		40
				Clock	—	—		20
	D	I_{IL}	$V_{CC} = 5.25\text{V}, V_I = 0.4\text{V}$	—	—	-0.4	mA	
				Clear	—	—		-0.8
				Preset	—	—		-0.8
				Clock	—	—		-0.4
	D	I_I	$V_{CC} = 5.25\text{V}, V_I = 7\text{V}$	—	—	0.1	mA	
				Clear	—	—		0.2
				Preset	—	—		0.2
				Clock	—	—		0.1
Short-circuit output current	I_{OS}	$V_{CC} = 5.25\text{V}$	-20	—	-100	mA		
Supply current	I_{CC}^{**}	$V_{CC} = 5.25\text{V}$	—	4	8	mA		
Input clamp voltage	V_{IK}	$V_{CC} = 4.75\text{V}, I_{IN} = -18\text{mA}$	—	—	-1.5	V		

* $V_{CC} = 5\text{V}, T_a = 25^\circ\text{C}$

** With all outputs open, I_{CC} is measured with the Q and \bar{Q} outputs high in turn. At the time of measurement, the clock input is grounded.

HD74LS74A

SWITCHING CHARACTERISTICS ($V_{CC}=5V$, $T_a=25^\circ C$)

Item	Symbol	Inputs	Outputs	Test Condition	min	typ	max	Unit
Maximum clock frequency	f_{max}			$C_L=15pF$, $R_L=2k\Omega$	25	33	-	MHz
Propagation delay time	t_{PLH}	Clock, Clear	Q, \bar{Q}		-	13	25	ns
	t_{PHL}	or Preset			-	25	40	ns

TESTING METHOD

1) Test Circuit

1.1) f_{max} , t_{PLH} , t_{PHL} (Clock→Q, \bar{Q})

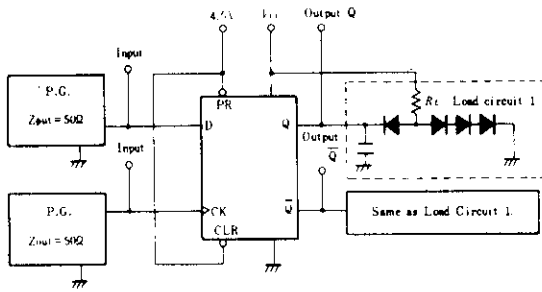

1.2) t_{PHL} , t_{PLH} (Clear or Preset→Q, \bar{Q})

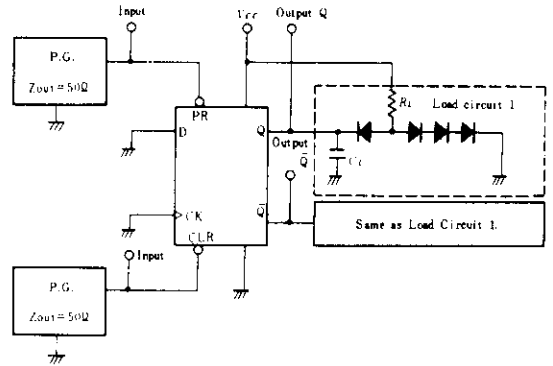

- Notes) 1. Test is put into the each flip-flop
 2. All diodes are 1S2074 (⊕).
 3. C_L includes probe and jig capacitance.

- Notes) 1. Test is put into the each flip-flop
 2. All diodes are 1S2074 (⊕).
 3. C_L includes probe and jig capacitance.

Waveform

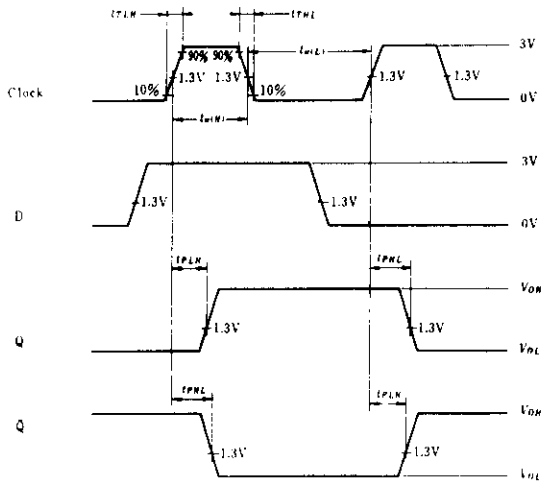

Note) Clock input pulse; $t_{TLH} \leq 15ns$,
 $t_{THL} \leq 6ns$, $PRR=1MHz$, duty
 cycle=50% and; for f_{max} ,
 $t_{TLH} = t_{THL} \leq 2.5ns$.

Waveform

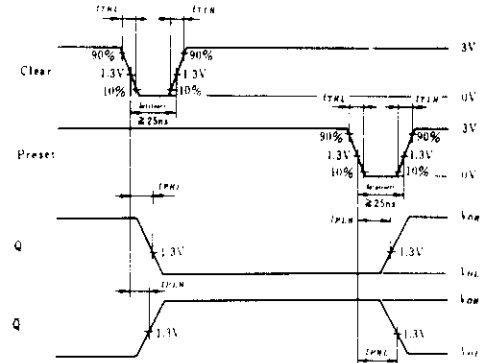

Note) Clear and preset input pulse;
 $t_{TLH} \leq 15ns$, $t_{THL} \leq 6ns$,
 $PRR=1MHz$



Hitachi Code	DP-14
JEDEC	Conforms
EIAJ	Conforms
Weight (reference value)	0.97 g

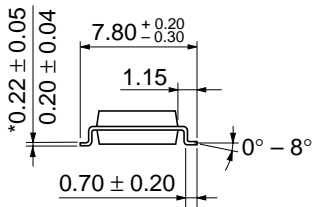
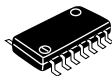

Hitachi Code	FP-14DA
JEDEC	—
EIAJ	Conforms
Weight (reference value)	0.23 g

*Dimension including the plating thickness
Base material dimension



Hitachi Code	FP-14DN
JEDEC	Conforms
EIAJ	Conforms
Weight (reference value)	0.13 g

Cautions

1. Hitachi neither warrants nor grants licenses of any rights of Hitachi's or any third party's patent, copyright, trademark, or other intellectual property rights for information contained in this document. Hitachi bears no responsibility for problems that may arise with third party's rights, including intellectual property rights, in connection with use of the information contained in this document.
2. Products and product specifications may be subject to change without notice. Confirm that you have received the latest product standards or specifications before final design, purchase or use.
3. Hitachi makes every attempt to ensure that its products are of high quality and reliability. However, contact Hitachi's sales office before using the product in an application that demands especially high quality and reliability or where its failure or malfunction may directly threaten human life or cause risk of bodily injury, such as aerospace, aeronautics, nuclear power, combustion control, transportation, traffic, safety equipment or medical equipment for life support.
4. Design your application so that the product is used within the ranges guaranteed by Hitachi particularly for maximum rating, operating supply voltage range, heat radiation characteristics, installation conditions and other characteristics. Hitachi bears no responsibility for failure or damage when used beyond the guaranteed ranges. Even within the guaranteed ranges, consider normally foreseeable failure rates or failure modes in semiconductor devices and employ systemic measures such as fail-safes, so that the equipment incorporating Hitachi product does not cause bodily injury, fire or other consequential damage due to operation of the Hitachi product.
5. This product is not designed to be radiation resistant.
6. No one is permitted to reproduce or duplicate, in any form, the whole or part of this document without written approval from Hitachi.
7. Contact Hitachi's sales office for any questions regarding this document or Hitachi semiconductor products.

HITACHI

Hitachi, Ltd.

Semiconductor & Integrated Circuits.
Nippon Bldg., 2-6-2, Ohte-machi, Chiyoda-ku, Tokyo 100-0004, Japan
Tel: Tokyo (03) 3270-2111 Fax: (03) 3270-5109

URL North America : <http://semiconductor.hitachi.com/>
 Europe : <http://www.hitachi-eu.com/hel/ecg>
 Asia (Singapore) : <http://www.has.hitachi.com.sg/grp3/sicd/index.htm>
 Asia (Taiwan) : http://www.hitachi.com.tw/E/Product/SICD_Frame.htm
 Asia (HongKong) : <http://www.hitachi.com.hk/eng/bo/grp3/index.htm>
 Japan : <http://www.hitachi.co.jp/Sicd/indx.htm>

For further information write to:

Hitachi Semiconductor
(America) Inc.
179 East Tasman Drive,
San Jose, CA 95134
Tel: <1> (408) 433-1990
Fax: <1> (408) 433-0223

Hitachi Europe GmbH
Electronic components Group
Dornacher Straße 3
D-85622 Feldkirchen, Munich
Germany
Tel: <49> (89) 9 9180-0
Fax: <49> (89) 9 29 30 00

Hitachi Europe Ltd.
Electronic Components Group.
Whitebrook Park
Lower Cookham Road
Maidenhead
Berkshire SL6 8YA, United Kingdom
Tel: <44> (1628) 585000
Fax: <44> (1628) 778322

Hitachi Asia Pte. Ltd.
16 Collyer Quay #20-00
Hitachi Tower
Singapore 049318
Tel: 535-2100
Fax: 535-1533

Hitachi Asia Ltd.
Taipei Branch Office
3F, Hung Kuo Building, No.167,
Tun-Hwa North Road, Taipei (105)
Tel: <886> (2) 2718-3666
Fax: <886> (2) 2718-8180

Hitachi Asia (Hong Kong) Ltd.
Group III (Electronic Components)
7/F., North Tower, World Finance Centre,
Harbour City, Canton Road, Tsim Sha Tsui,
Kowloon, Hong Kong
Tel: <852> (2) 735 9218
Fax: <852> (2) 730 0281
Telex: 40815 HITEC HX

Copyright ' Hitachi, Ltd., 1999. All rights reserved. Printed in Japan.

HITACHI