

DBL 5023

FM RECEIVER & COMPANDOR SYSTEM

The DBL5023, is a monolithic integrated circuit which consist of FM receiver and Compandor for high performance 46/49MHz Analog cordless phone system.

FM receiver includes Oscillator, Mixer, Limiting IF Amplifier, Demodulator, Active filter Amplifier and Scanning control circuit.

Compandor includes Compressor, Expander, Mic Amplifier, ALC(automatic level control) and Mute logic.

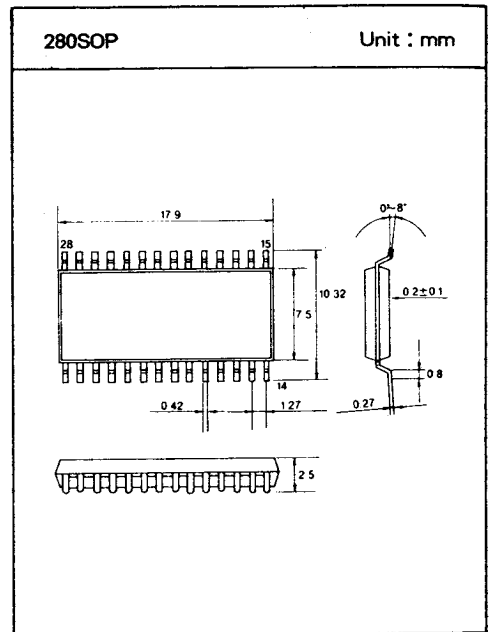

□ FEATURES

- Wide Operating Supply Voltage Range : 2.2~8.0V
- Built-in dual conversion receiver, Compandor with ALC
- FM Receiver part
 - Recovered audio output : 162mVrms
 - Excellent Sensitivity(-3dB Limiting) : 2uVrms
 - Operating Frequency up to 60MHz
- Compandor part
 - Compressor output level($V_{in}=13\text{mVrms}$) : 292mVrms
 - Expander output level($V_{in}=180\text{mVrms}$) : 125mVrms
 - Muting attenuation : 80dB
 - ALC output level($V_2=0.85\text{V}$) : 335mVrms

DBL 5023

MAXIMUM RATINGS ($T_a = 25^\circ\text{C}$)

Characteristic	Symbol	Rating	Unit
Maximum Supply Voltage	Vcc	10	V
Power Dissipation	Pd	850	mW
Operating Temperature	Topr	-25 ~ +75	°C
Storage Temperature	Tstg	-65 ~ +150	°C

BLOCK DIAGRAM & PIN CONFIGURATION

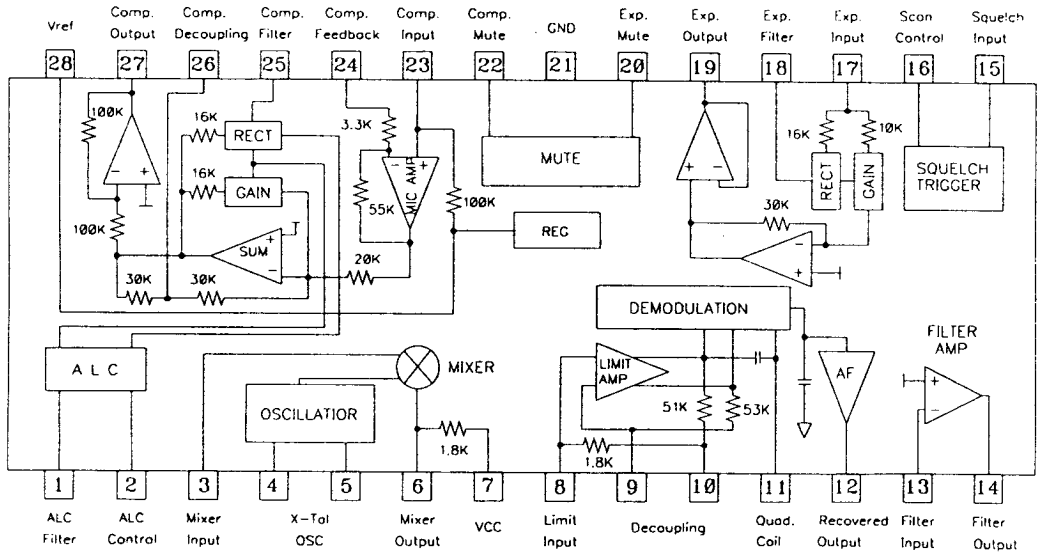

DBL 5023

□ PIN DESCRIPTIONS

Pin No	Symbol	Dc Voltage (V)	Description
1	ALC Fiter	0.0	– Used for adjusting output voltage THD of Compressor to less than 3%, or to limit the frequency deviaion of Tx in case the input is higher than a certain level.
2	ALC Control	0.0	– Reference input terminal voltage of ALC(Automatic level control). ALC circuit may be turned off according to the ALC reference voltage, or magnitude of output voltage may be limited if it is higher than a certain level.
3 6	Mixer Input Mixer Output	1.72 2.70	– Input terminal of second Mixer. Output from first Mixer is entered to second Mixer input terminal via 10.7MHz ceramic filter. Second Mixer converts frequency to second intermediate frequency(455KHz : AM IF)
4 5	Crystal Oscillator	2.95 2.35	– Input terminal of second local oscillator. It generates second local oscillator frequency to convert output from first Mixer(10.7MHz) to second intermediate frequency. – Oscillator with 10.245MHz crystal.
7	Vcc	3.0	– Supply voltage terminal.
8	Limit Input	2.60	– Signal input for IF(455KHz) Amplifier/Limiter.
9, 10	Decoupling	2.60	– IF Amplifier/Limiter capacitor pins.
11	Quad Coil	3.0	– Quadrature coil input terminal. The 455KHz oscillator circuit is comprised of L/C tank circuit. Voice signal is detected by mixture of 455KHz(by phass difference) which is converted from second Mixer.
12	Recovered Audio	0.95	It is a recovered audio output terminal. Voice signal which is detected by Quadrature detector is amplified and out via this terminal.

DBL 5023

PIN DESCRIPTIONS(continued)

Pin No	Symbol	Dc Voltage (V)	Description
13	Filter Amp	0.80	Filter Amp. and Squelch circuit for communications and scanning receivers.
14		1.20	
15	Squelch	0	
16	Trigger	2.90	
17	Expander Input	1.46	<p>– Sum Amp. input terminal of Expander.</p> <p>The Voice signal recovered after the demodulation waveform from the receiver passed through a two level low pass filter enters this terminal.</p>
18	Expander Filter	0.50	– Used for tuning waveform from the full wave rectifier to DC element at the rectifier block of expander.
19	Expander Output	1.46	– Output terminal of expander, from which a regenerated voice signal comes out.
20	Expander Mute	1.30	<p>– Expander mute terminal of Compandor and the final mute block of an expander located next to the receiver terminal.</p> <p>It blocks the data signal of Micom being transmitted to an user, and is connected to the Rx mute terminal of Micom.</p> <p>Expanding is executed if this terminal is high, and expander mute is executed if it is low.</p>
21	GND	0	– Ground terminal.
22	Compressor Mute	1.30	<p>– Compressor mute terminal of compandor mute block is used to avoid duplication of data transmission from Micom(between the base and hand set) with the voice signal.</p> <p>It is connected to the Tx mute terminal of Micom.</p> <p>Compressing is executed if the terminal is high and compressor mute is executed if it is low.</p>
23	Compressor Input	1.46	– MIC Amp. non-inverting input terminal of compressor and is used as an input terminal for voice signal.

DBL 5023

PIN DESCRIPTIONS(continued)

Pin No	Symbol	Dc Voltage (V)	Description
13	Filter Amp	0.80	Filter Amp. and Squelch circuit for communications and scanning receivers.
14		1.20	
15	Squelch	0	
16	Trigger	2.90	
17	Expander Input	1.46	<p>– Sum Amp. input terminal of Expander.</p> <p>The Voice signal recovered after the demodulation waveform from the receiver passed through a two level low pass filter enters this terminal.</p>
18	Expander Filter	0.50	– Used for tuning waveform from the full wave rectifier to DC element at the rectifier block of expander.
19	Expander Output	1.46	– Output terminal of expander, from which a regenerated voice signal comes out.
20	Expander Mute	1.30	<p>– Expander mute terminal of Compandor and the final mute block of an expander located next to the receiver terminal.</p> <p>It blocks the data signal of Micom being transmitted to an user, and is connected to the Rx mute terminal of Micom.</p> <p>Expanding is executed if this terminal is high, and expander mute is executed if it is low.</p>
21	GND	0	– Ground terminal.
22	Compressor Mute	1.30	<p>– Compressor mute terminal of compandor mute block is used to avoid duplication of data transmission from Micom(between the base and hand set) with the voice signal.</p> <p>It is connected to the Tx mute terminal of Micom.</p> <p>Compressing is executed if the terminal is high and compressor mute is executed if it is low.</p>
23	Compressor Input	1.46	– MIC Amp. non-inverting input terminal of compressor and is used as an input terminal for voice signal.

DBL 5023

ELECTRICAL CHARACTERISTICS

(Unless otherwise specified, $T_a=25^{\circ}\text{C}$, $V_{cc}=3\text{V}$)

Characteristics	Symbol	Test Condition	Min.	Typ.	Max.	Unit	
Squelch Current (No Signal)	Icc 1	Squelch off ($V_{15}=2\text{V}$)	7.0	9.0	11.0	mA	
	Icc 2	Squelch on ($V_{15}=0\text{V}$)	8.0	10.0	12.0		
FM RECEIVER PART ($f_c=10.7\text{MHz}$, $f_m=1\text{KHz}$, $\Delta f=\pm 3\text{KHz}$, $R_s=50\text{ohm}$)							
Recoverd Audio Output	V_{rao}	$V_{in}=1\text{mVrms}$ $V_{in}(\text{RF})=-30\text{dBm}$	130.0	160.0	220.0	mVrms	
Input Limiting Voltage	V_{lim}	-3dB Limiting	-	2.0	6.0	μVrms	
Total Harmonic Distortion	THD	$V_{in}=1\text{mVrms}$ $V_{in}(\text{RF})=-30\text{dBm}$ $\text{BW}=400\sim 30\text{kHz}$	-	0.8	1.2	%	
Noise output voltage	V_{no}	No input signal	60.0	120.0	-	mVrms	
Drop voltage AF Gain Loss	ΔG_v	$V_{cc}=4.0\text{V}\rightarrow 2.2\text{V}$ $V_{in}(\text{RF})=-30\text{dBm}$	-0.8	-0.5	-	dB	
Detector output Impedance	R_{out}	-	-	450.0	-	Ω	
Signal to Noise Ratio	S/N	$V_{in}(\text{RF})=-30\text{dBm}$	36.0	67.0	-	dB	
Filter Amp. Gain	G_v (filter)	$f=10\text{KHz}$ $V_{in}=5\text{mVrms}$	40.0	47.0	56.0	dB	
Filter output DC Voltage	V_o (DC)	-	0.9	1.2	1.5	Vdc	
Scan Control	Low	V_{s1}	$V_{15}=2.0\text{V}$	-	0.0	0.5	Vdc
	High	V_{sh}	$V_{15}=\text{GND}$	3.0	3.5	-	Vdc
Mixer Conversion Gain	G_v (max)	$V_{in}=1\text{mVrms}$ $V_{in}(\text{RF})=30\text{dBm}$ No Load	20.0	28.0	36.0	dB	
Mixer Input Resistance	R_{in}	-	-	3.3	-	K Ω	
Mixer Input Capacitance	C_{in}	-	-	2.2	-	pF	

DBL 5023

□ ELECTRICAL CHARACTERISTICS(continued)

(Unless otherwise specified, $T_a=25^{\circ}\text{C}$, $V_{cc}=3\text{V}$)

Characteristics	Symbol	Test Condition	Min.	Typ.	Max.	Unit
COMPRESSOR PART ($f=1\text{KHz}$, $R(\text{load})=10\text{Kohm}$, $V_2=V_{28}$)						
Input Impedance	Zinc	—	70.0	100.0	—	Kohm
Standard Output Level	Voc	Vinc = 13mVrms, Vin=0dB	240.0	300.0	340.0	mVrms
Gain Error(1)	Gvc1	Vinc = -20dB	-0.5	0.0	0.5	dB
Gain Error(2)	Gvc2	Vinc = -40dB	-1.0	0.0	1.0	dB
Total Harmonic Distortion	THDc	Vin=0dB	—	0.5	1.0	%
Noise output	Vnoc	Rg=620ohm	—	5.0	8.0	mVrms
Mute Attenuation	Attc	Vinc=0dB, V22=GND	60.0	80.0	—	dB
Limiting Voltage	Vlimc	—	1.15	1.35	1.50	Vp-p
ALC output level	Valc	V ₂ =0.85V, Vine=10dB	300.0	340.0	380.0	mVrms
THD(ALC Operation)	THDalc		—	0.5	1.0	%
EXPANDER PART ($f=1\text{KHz}$, $R=10\text{Kohm}$)						
Input Impedance	Zine	—	6.0	6.2	—	K Ω
Standard Input Level	Vine	Voe=180mVrms, Vine=0dB	110.0	125.0	140.0	mVrms
Gain Error(1)	Gve1	Vine = -10dB	-0.5	0.0	0.5	dB
Gain Error(2)	Gve2	Vine = -20dB	-1.0	0.0	1.0	dB
Gain Error(3)	GVe3	Vine = -30dB	-1.5	0.0	1.5	dB
Total Harmonic Distortion	THDe	Vine=0dB, f=1KHz	—	0.5	1.5	%
Noise Output	Vnoe	Rg=680ohm	—	10.0	50.0	μVrms
Mute Attenuation	Atte	Vine=0dB, V20=GND	60.0	80.0	—	dB
Max. Output Voltage	Vout(max)	THD=10%	700.0	860.0	—	mVrms

DBL 5023

□ TEST CIRCUIT

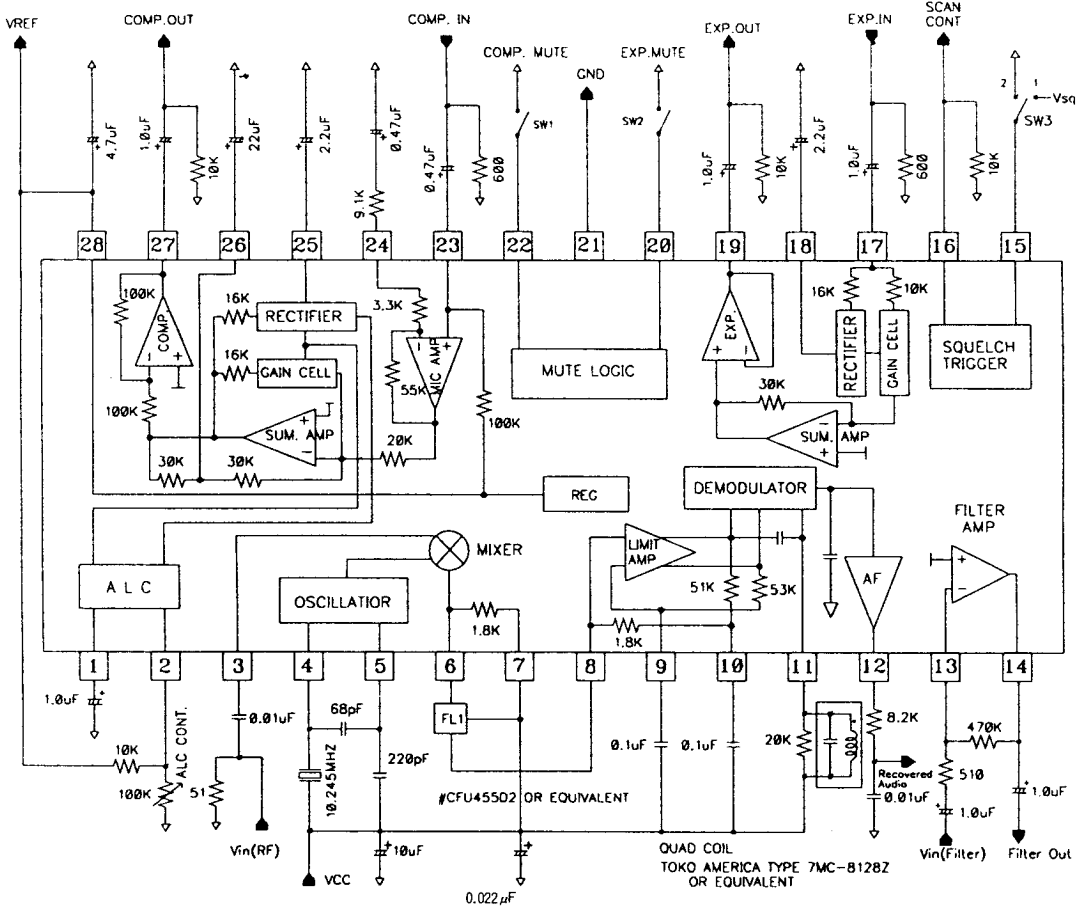

DBL 5023

TYPICAL PERFORMANCE CHARACTERISTICS

FIGURE 1

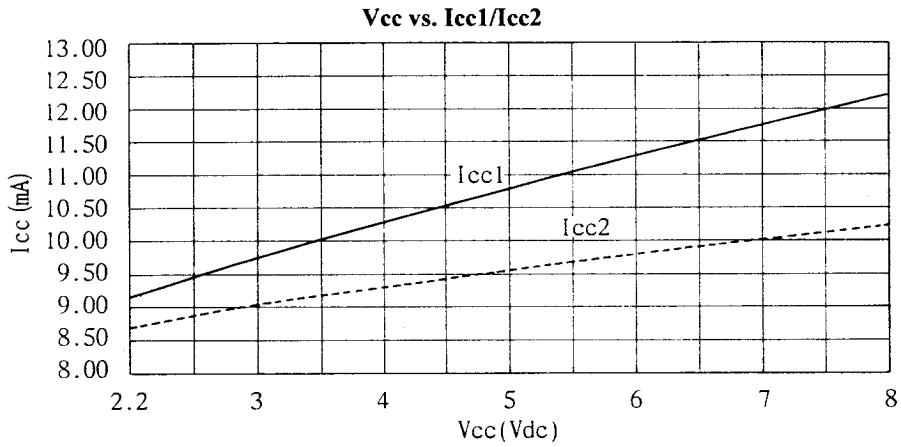

FIGURE 2

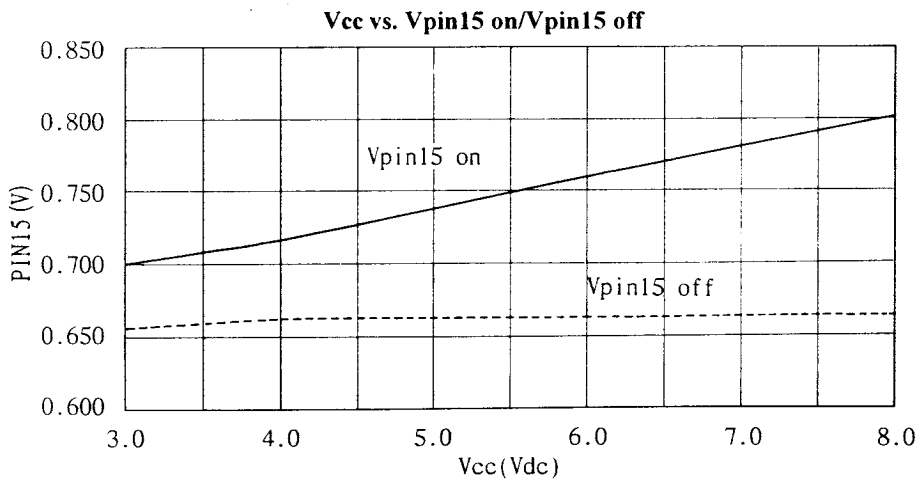

FIGURE 3

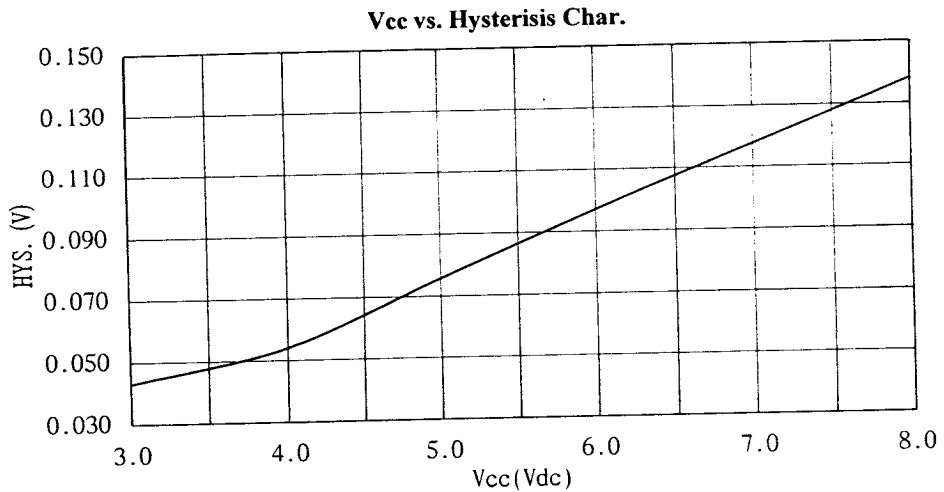

FIGURE 4

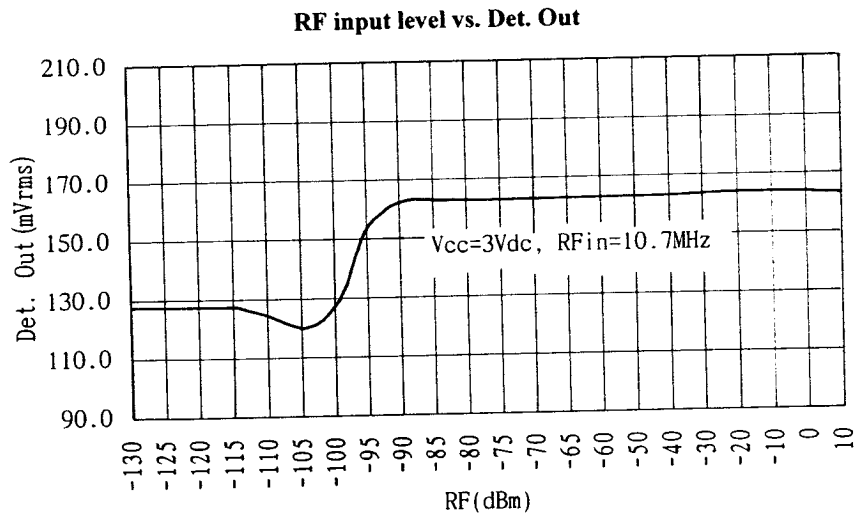

FIGURE 3

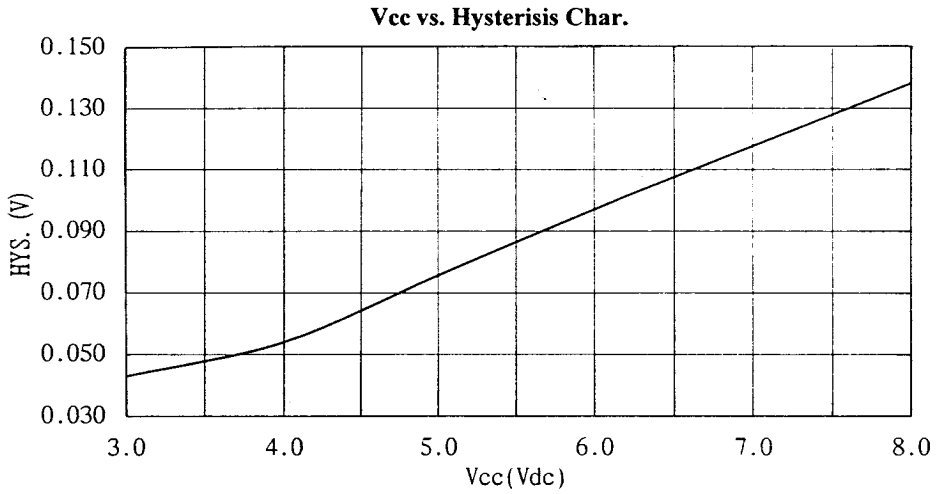

FIGURE 4

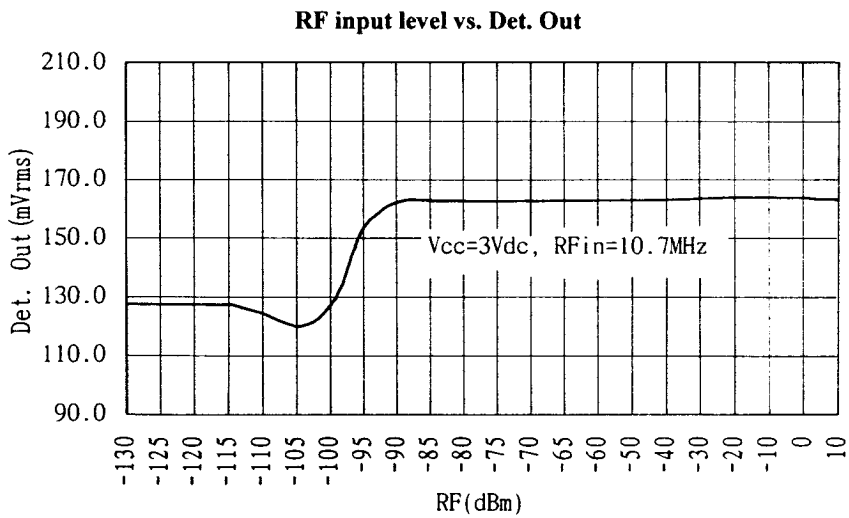

FIGURE 7

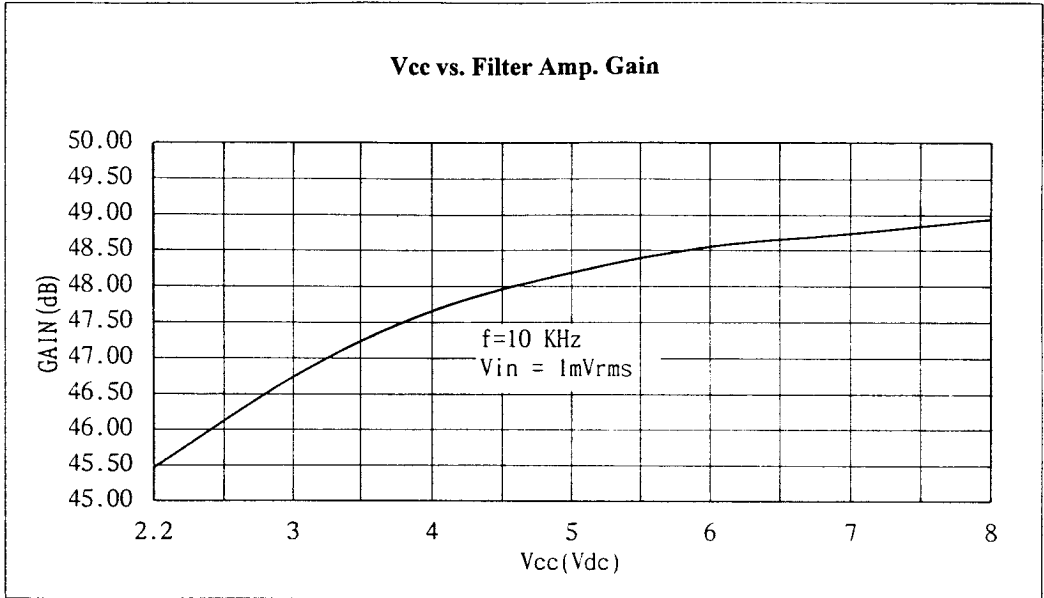

FIGURE 8

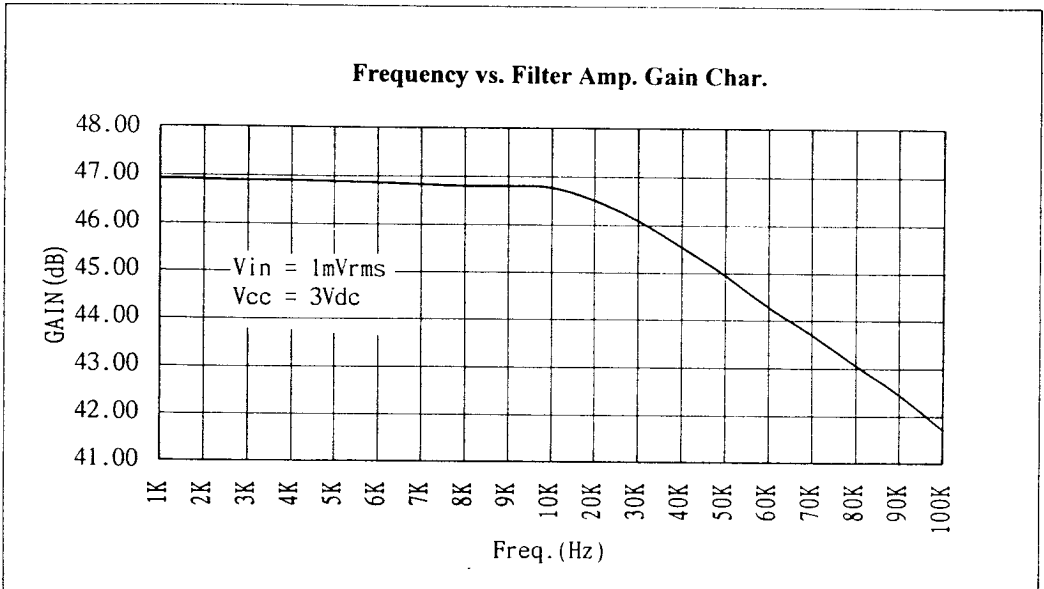

FIGURE 9

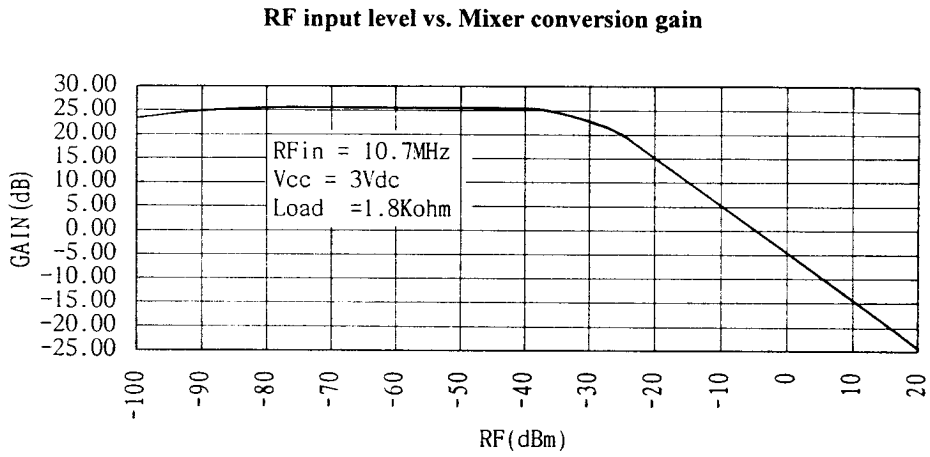

FIGURE 10

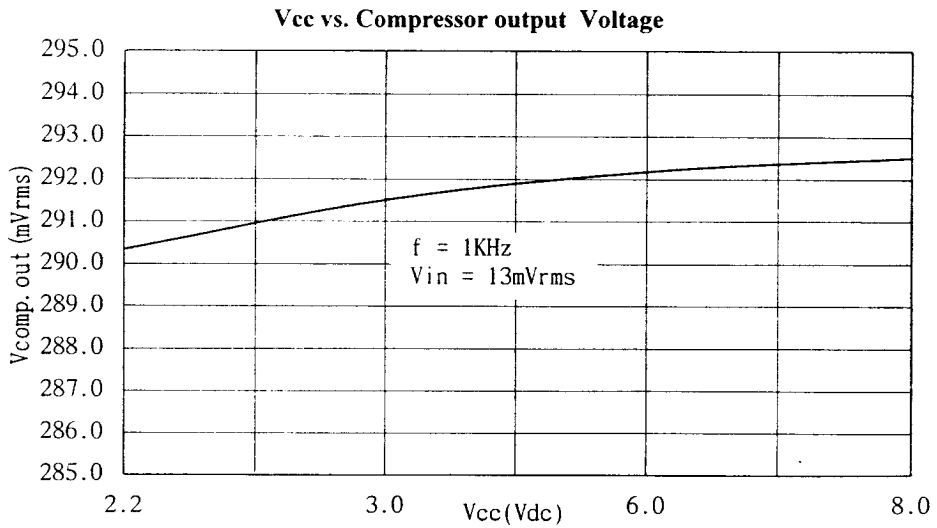

FIGURE 7

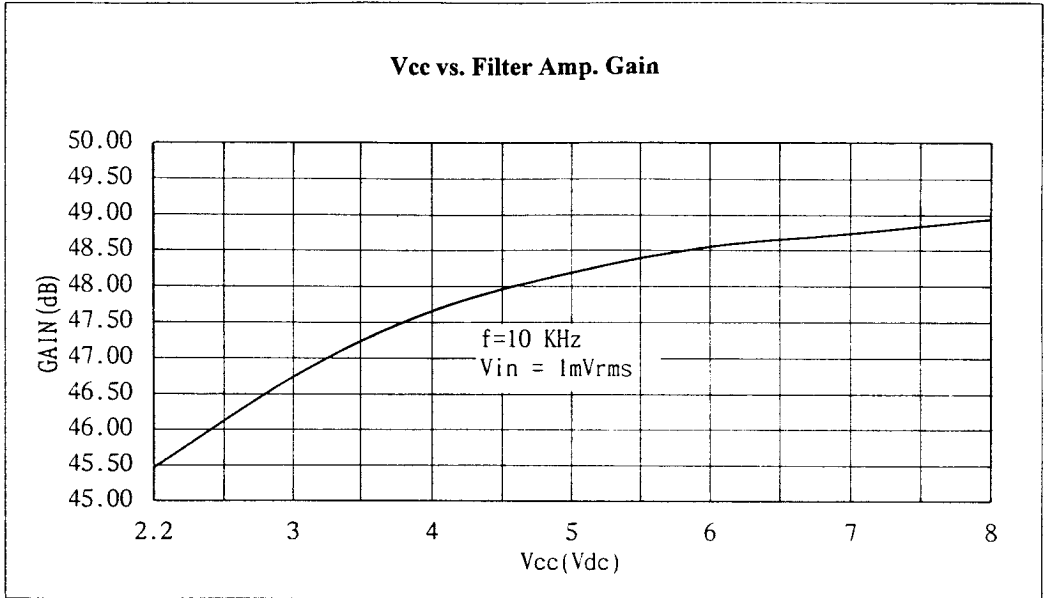

FIGURE 8

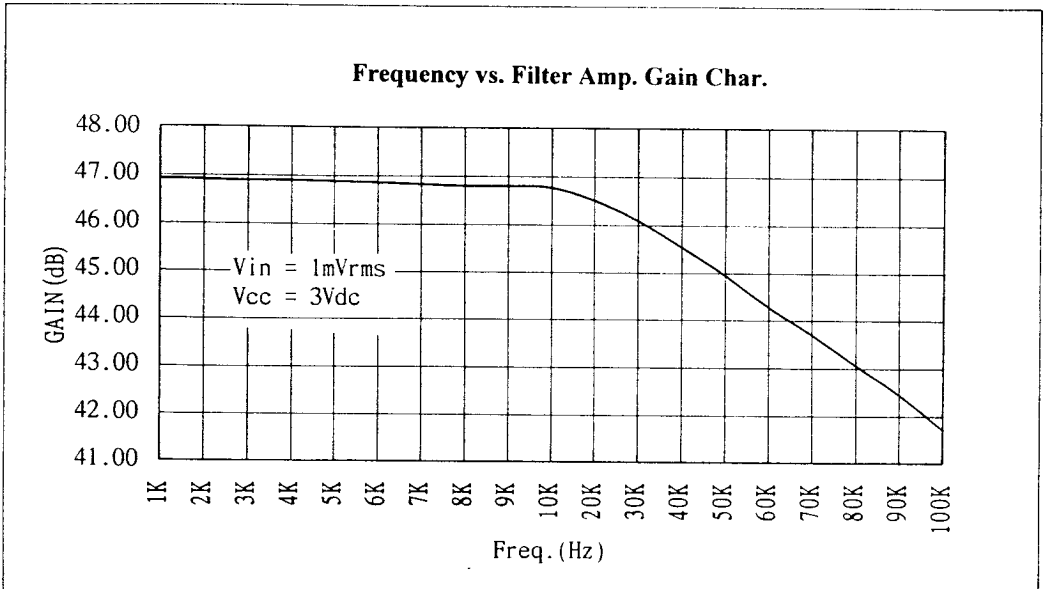

FIGURE 9

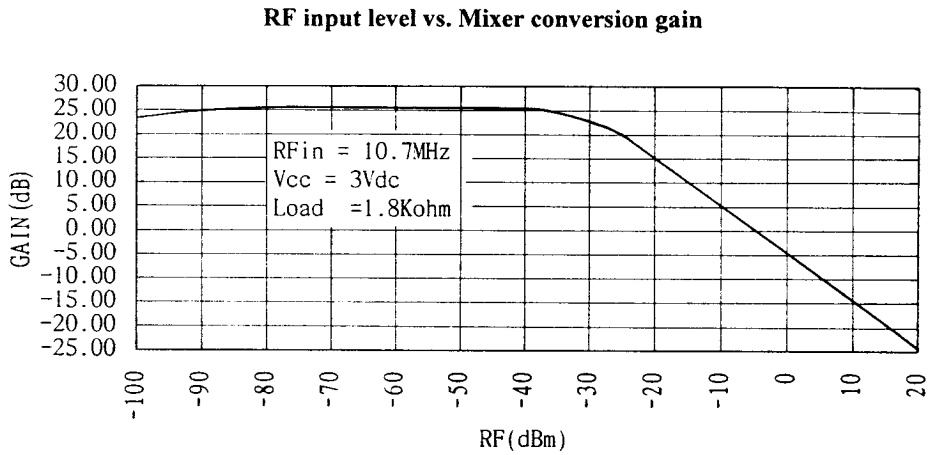

FIGURE 10

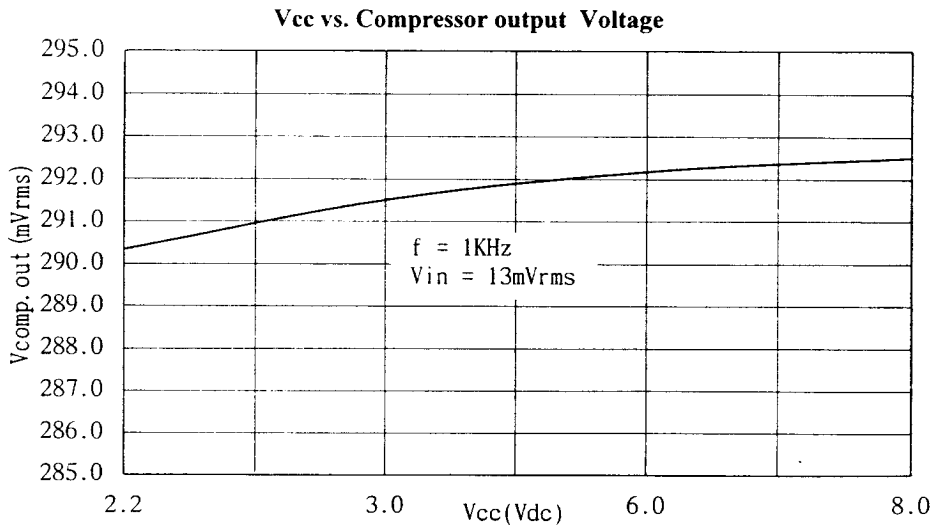

FIGURE 15

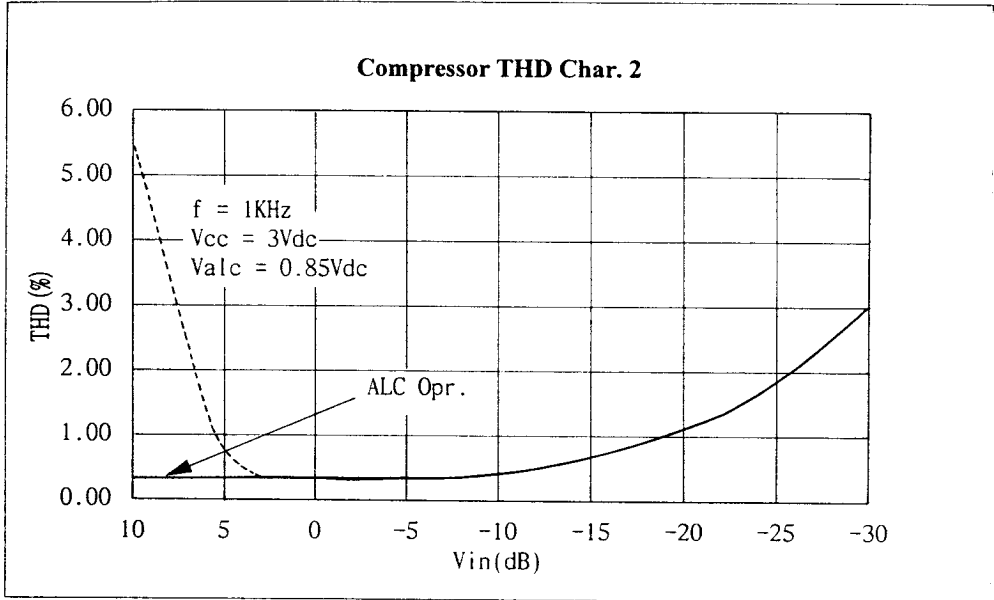

FIGURE 16

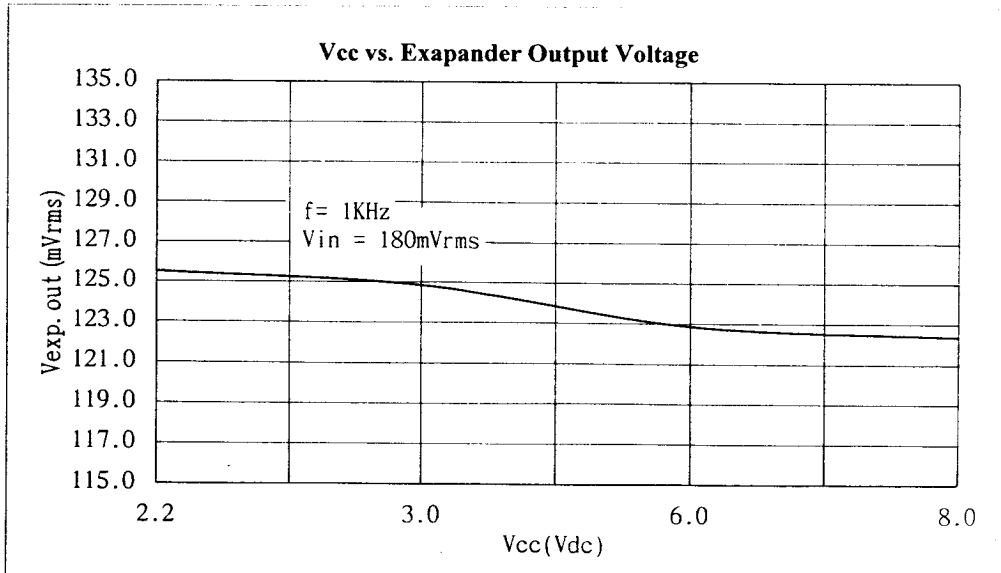

FIGURE 17

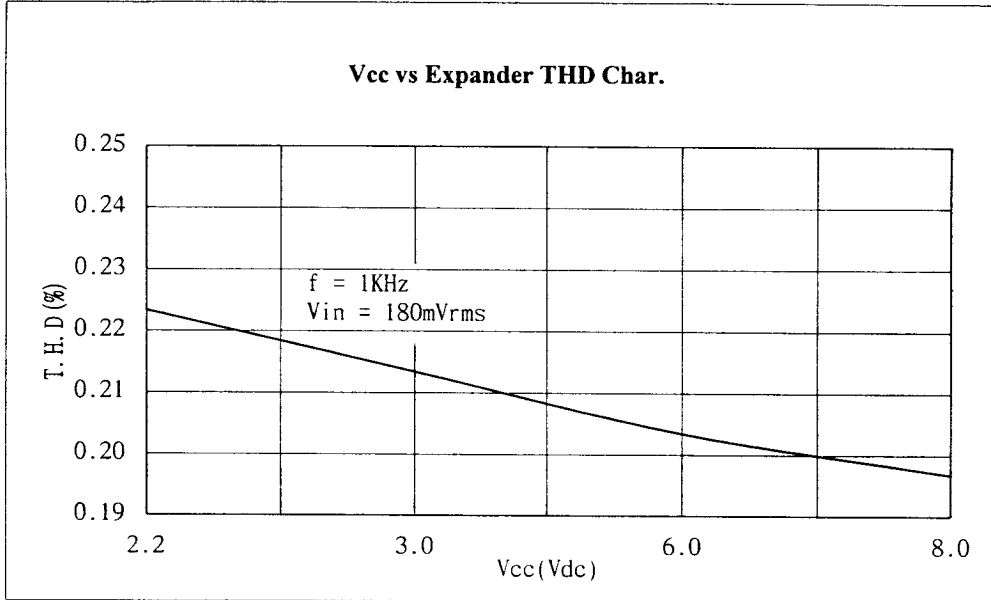

FIGURE 18

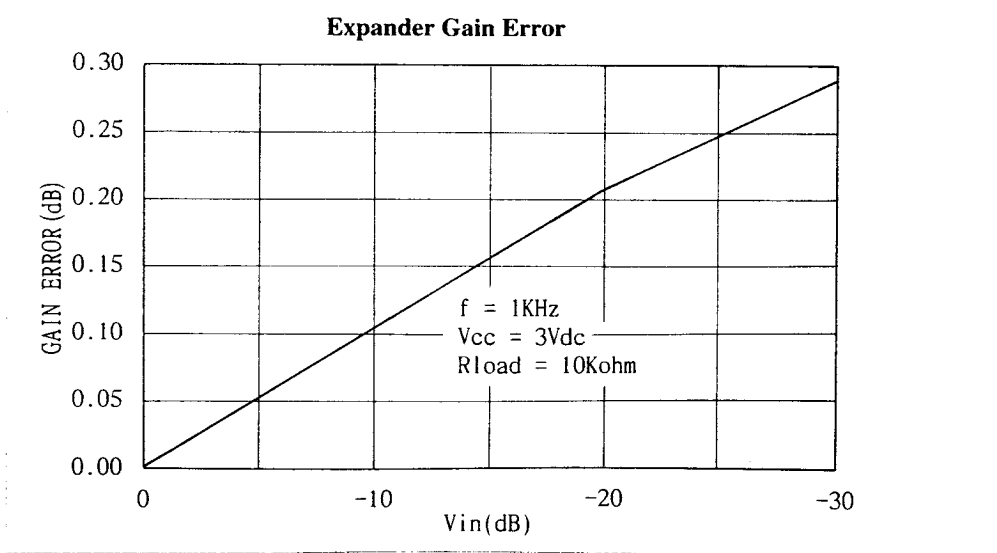

FIGURE 19

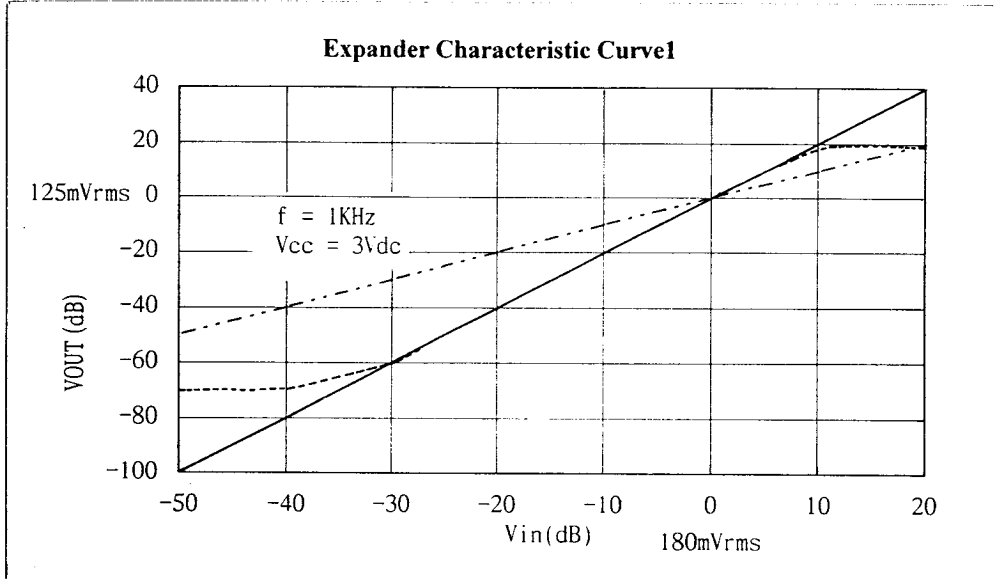

FIGURE 20

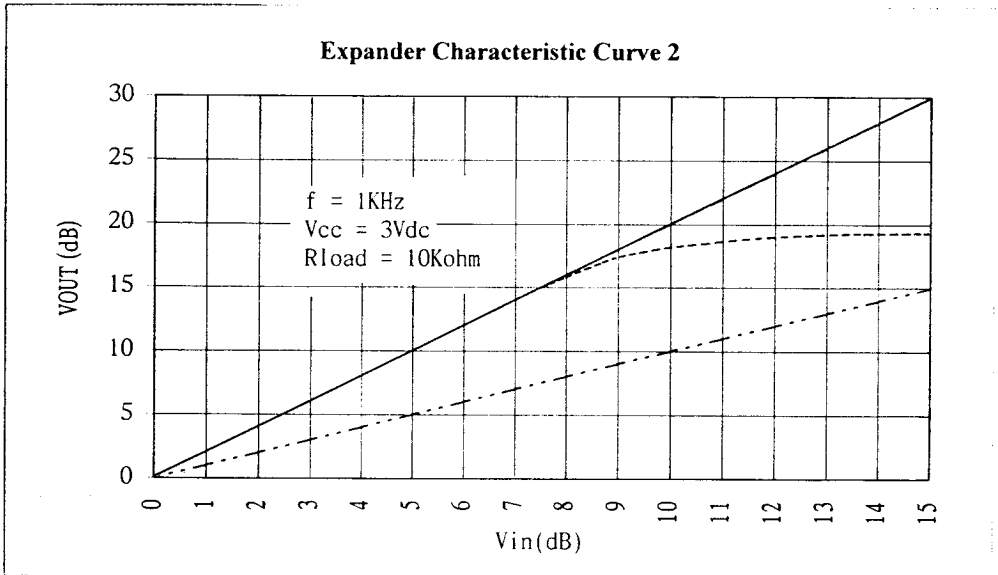

FIGURE 21

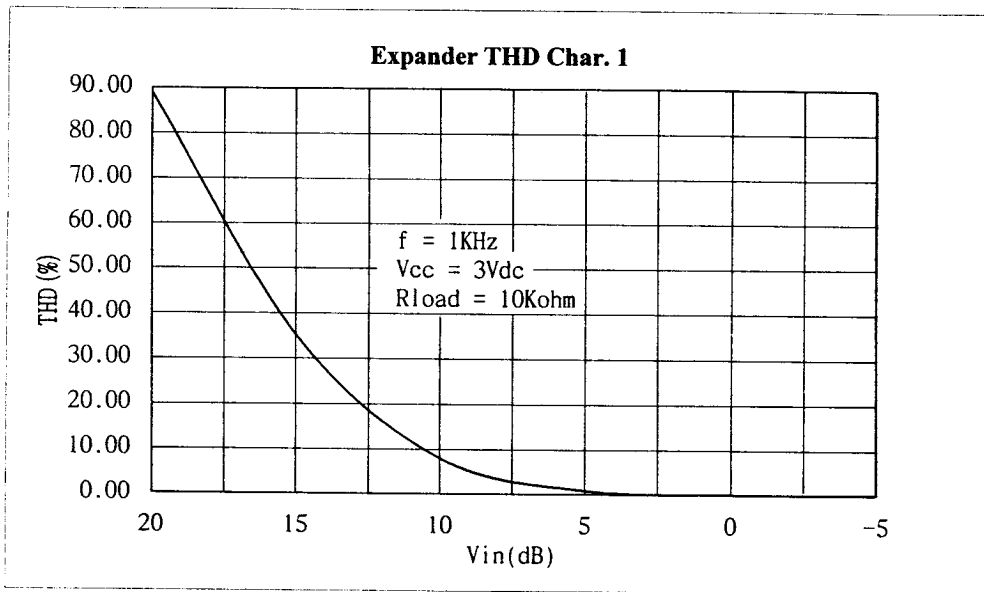

FIGURE 22

