

PTF 10138

60 Watts, 860-960 MHz

GOLDMOS® Field Effect Transistor

Description

The PTF 10138 is a 60-watt GOLDMOS FET intended for amplifier applications to 860-960 MHz. It operates at 48% efficiency with 12.5 dB gain. Nitride surface passivation and full gold metallization ensure excellent device lifetime and reliability.

- Performance at 960 MHz, 28 Volts
 - Output Power = 60 Watts Min
 - Power Gain = 12.5 dB Typ
 - Efficiency = 48% Min
- Full Gold Metallization
- Silicon Nitride Passivated
- Excellent Thermal Stability
- Back Side Common Source
- 100% Lot Traceability
- Available in Package 20251 as PTF 10139

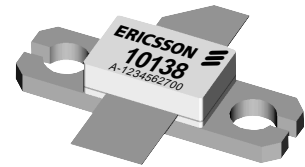
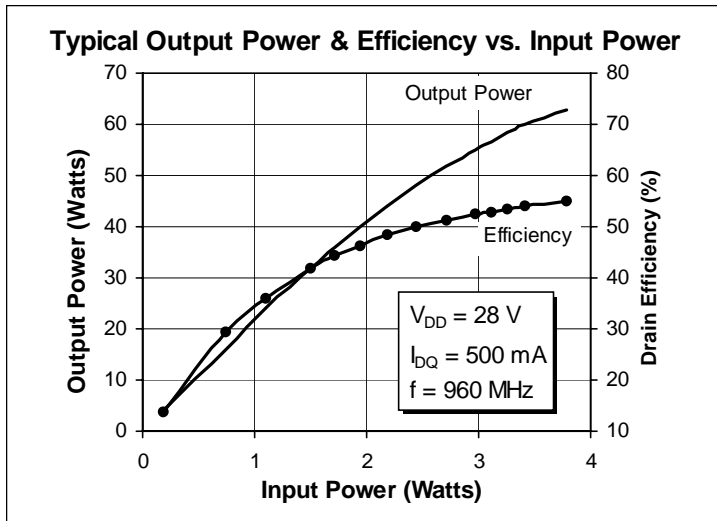

Package 20256



Also available in Package 20251

RF Specifications (100% Tested)

Characteristic	Symbol	Min	Typ	Max	Units
Common Source Power Gain ($V_{DD} = 28\text{ V}$, $P_{OUT} = 60\text{ W}$, $I_{DQ} = 500\text{ mA}$, $f = 960\text{ MHz}$)	G_{ps}	11.5	12.5	—	dB
Power Output at 1 dB Compression ($V_{DD} = 28\text{ V}$, $I_{DQ} = 500\text{ mA}$, $f = 960\text{ MHz}$)	P-1dB	60	—	—	Watts
Drain Efficiency ($V_{DD} = 28\text{ V}$, $P_{OUT} = 60\text{ W}$, $I_{DQ} = 500\text{ mA}$, $f = 960\text{ MHz}$)	η	48	55	—	%
Load Mismatch Tolerance ($V_{DD} = 28\text{ V}$, $P_{OUT} = 60\text{ W}$, $I_{DQ} = 500\text{ mA}$, $f = 960\text{ MHz}$ — all phase angles at frequency of test)	Ψ	—	—	10:1	—

All published data at $T_{CASE} = 25^\circ\text{C}$ unless otherwise indicated.

Electrical Characteristics (100% Tested)

Characteristic	Conditions	Symbol	Min	Typ	Max	Units
Drain-Source Breakdown Voltage	$V_{GS} = 0\text{ V}, I_D = 25\text{ mA}$	$V_{(BR)DSS}$	65	—	—	Volts
Drain-Source Leakage Current	$V_{DS} = 28\text{ V}, V_{GS} = 0\text{ V}$	I_{DSS}	—	—	1.0	mA
Gate-Source Leakage Current	$V_{GS} = 20\text{ V}, V_{DS} = 0\text{ V}$	I_{GSS}	—	—	1	μA
Gate Threshold Voltage	$V_{DS} = 10\text{ V}, I_D = 75\text{ mA}$	$V_{GS(th)}$	3.0	—	5.0	Volts
Forward Transconductance	$V_{DS} = 10\text{ V}, I_D = 3\text{ A}$	g_{fs}	—	2.8	—	Siemens

Maximum Ratings

Parameter	Symbol	Value	Unit
Drain-Source Voltage	V_{DSS}	65	Vdc
Gate-Source Voltage	V_{GS}	± 20	Vdc
Drain Current - Continuous	I_D	7	Adc
Operating Junction Temperature	T_J	200	$^{\circ}\text{C}$
Total Device Dissipation Above 25°C derate by	P_D	194 1.11	Watts $\text{W}/^{\circ}\text{C}$
Storage Temperature Range	T_{STG}	-65 to 150	$^{\circ}\text{C}$
Thermal Resistance ($T_{CASE} = 70^{\circ}\text{C}$)	$R_{\theta JC}$	0.9	$^{\circ}\text{C}/\text{W}$

Typical Performance

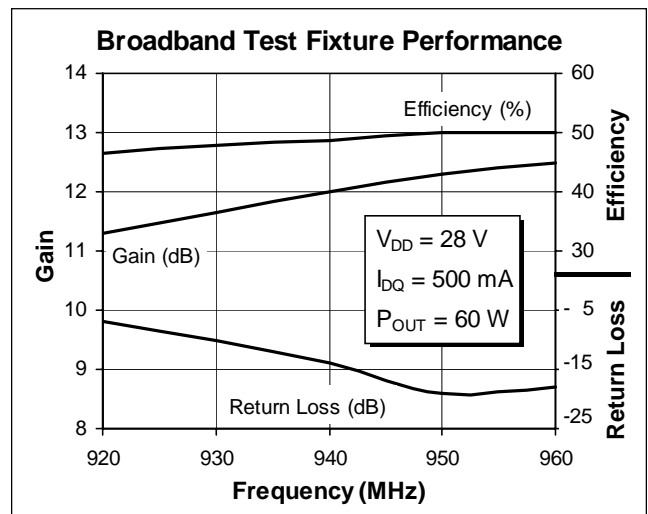
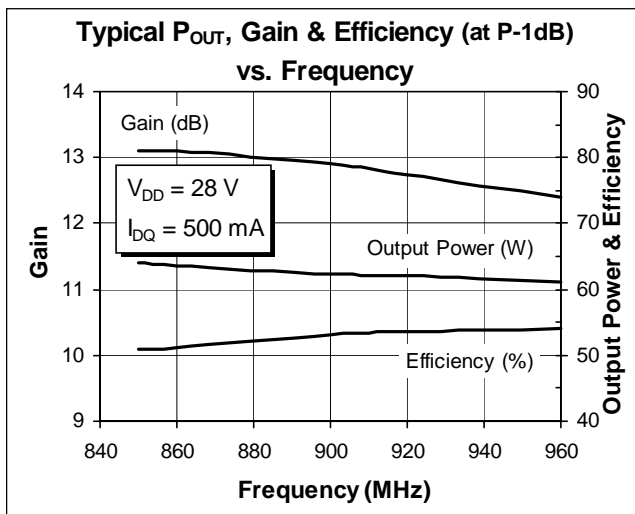

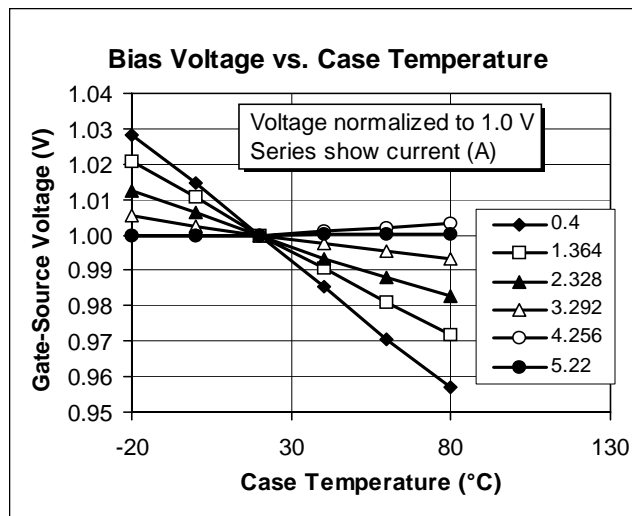
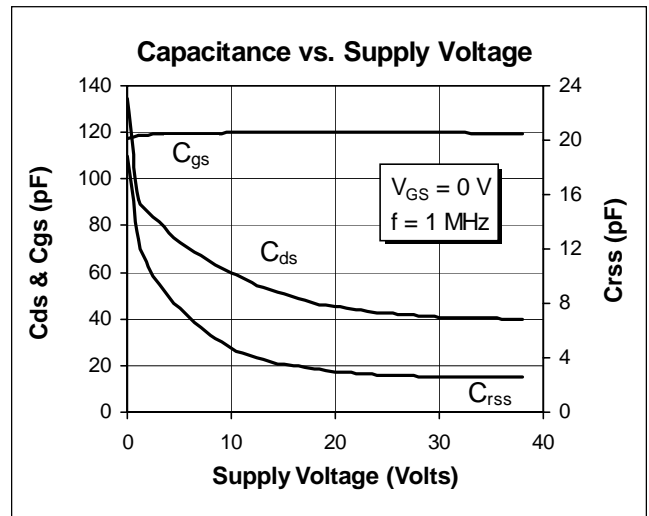
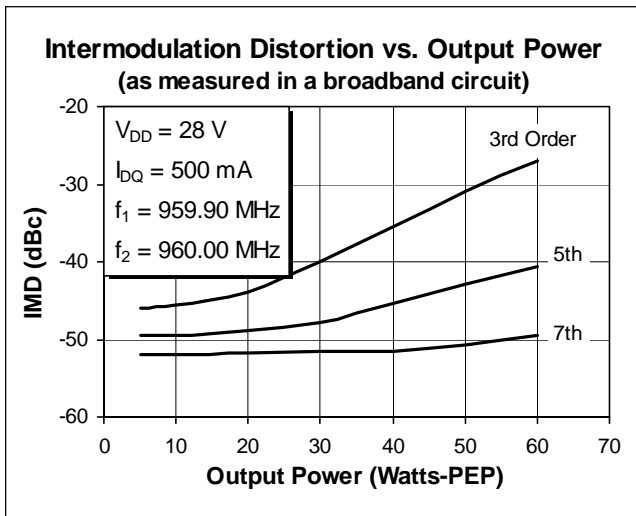
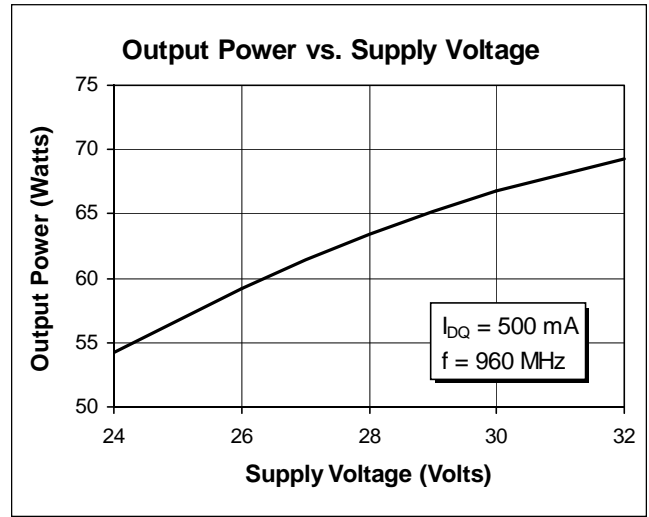
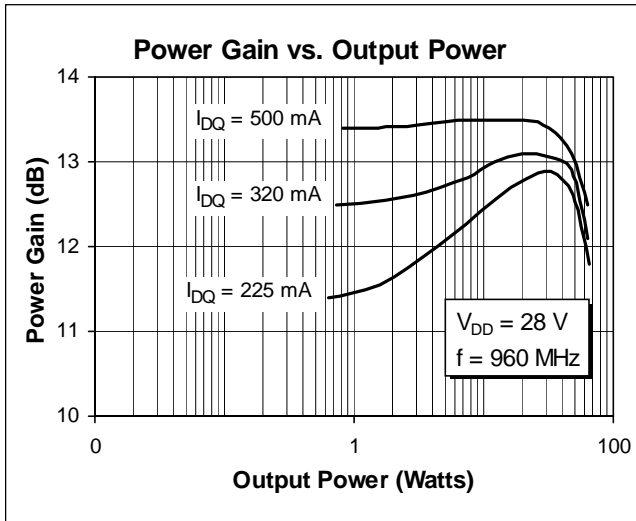

Impedance Data

$V_{DD} = 28\text{ V}$, $P_{OUT} = 60\text{ W}$, $I_{DQ} = 500\text{ mA}$

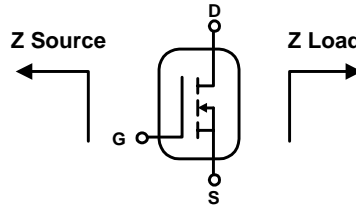

Frequency MHz	Z Source Ω		Z Load Ω	
	R	jX	R	jX
850	0.60	0.40	2.35	0.74
860	0.56	0.56	2.20	0.72
900	0.55	0.80	1.80	0.95
920	0.58	0.90	1.80	1.10
960	0.65	1.10	1.80	1.30

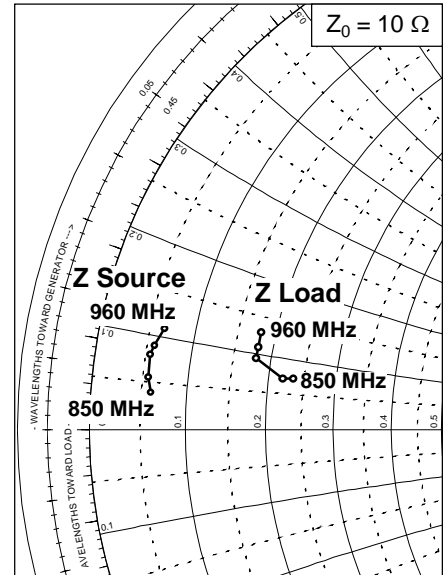

Typical Scattering Parameters

($V_{DS} = 28\text{ V}$, $I_D = 1.5\text{ A}$)

f (MHz)	S11		S21		S12		S22	
	Mag	Ang	Mag	Ang	Mag	Ang	Mag	Ang
300	0.941	-175	2.70	36.8	0.028	-82.1	0.993	-175
350	0.949	-176	2.09	32.7	0.022	-82.7	0.990	-176
400	0.958	-178	1.71	28.3	0.017	-83.6	0.991	-178
450	0.968	-179	1.40	24.7	0.013	-82.9	0.994	-179
500	0.975	-179	1.20	22.3	0.009	-83.4	0.998	-179
550	0.973	180	1.03	18.0	0.006	-78.3	0.996	-180
600	0.974	179	0.892	14.6	0.003	-71.0	0.996	180
650	0.982	178	0.788	10.5	0.001	-19.9	0.996	179
700	0.985	177	0.671	6.38	0.003	44.0	0.997	178
750	0.981	177	0.576	3.31	0.004	68.8	0.999	178
800	0.979	176	0.489	0.641	0.007	71.9	0.996	177
850	0.986	175	0.425	0.228	0.008	70.1	0.990	176
900	0.984	175	0.378	0.643	0.010	76.6	0.992	176
950	0.986	174	0.342	-0.107	0.011	79.0	0.994	176
1000	0.992	173	0.316	-0.098	0.014	81.0	0.996	175
1050	0.990	173	0.294	-0.827	0.016	80.6	0.989	175
1100	0.983	172	0.264	-1.69	0.018	78.5	0.985	174
1150	0.984	171	0.245	-2.59	0.020	76.4	0.990	173
1200	0.993	171	0.228	-3.43	0.022	76.2	0.993	173
1250	0.991	171	0.211	-3.76	0.023	76.6	0.987	173
1300	0.986	170	0.192	-4.91	0.025	76.4	0.986	173
1350	0.982	169	0.179	-4.94	0.028	73.3	0.988	172
1400	0.990	169	0.173	-5.51	0.030	69.4	0.986	172
1450	0.991	169	0.159	-5.77	0.029	67.2	0.990	171
1500	0.986	168	0.146	-5.99	0.030	66.3	0.985	171

Test Circuit

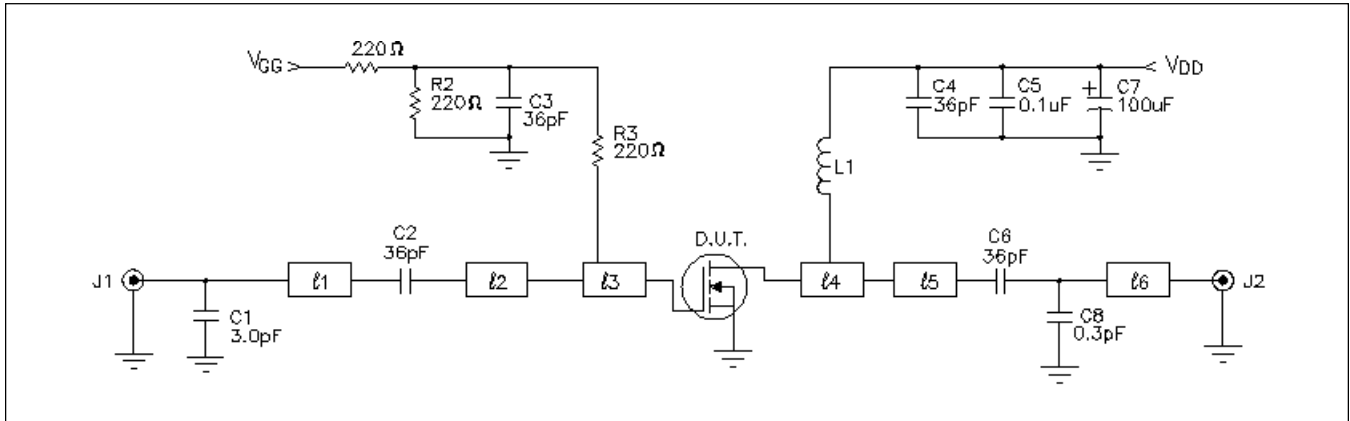

Test Circuit Schematic for $f = 960$ MHz

D.U.T.	PTF 10138		C1	3.0 pF Capacitor	100 B 3R0
l1	0.207λ 960 MHz	Microstrip 50 Ω	C2, C3, C4, C6	36 pF Capacitor	100 B 360
l2	0.075λ 960 MHz	Microstrip 15.7 Ω	C5	0.1 μ F, 50 V Capacitor	Digi-Key P4525-ND
l3	0.158λ 960 MHz	Microstrip 5.1 Ω	C7	100 μ F, 50 V Capacitor	Digi-Key P5182-ND
l4	0.214λ 960 MHz	Microstrip 8.3 Ω	C8	0.3 pF Capacitor	ATC 100 B
l5	0.015λ 960 MHz	Microstrip 50 Ω	L1	4 Turns, 22 AWG, .120" I.D.	N/A
l6	0.214λ 960 MHz	Microstrip 50 Ω	R1, R2, R3	220 Ω , 1/4 W Resistor	Digi-Key 220 QBK-NO
			Circuit Board	0.031" Thick, $\epsilon_r = 4.0$, AlliedSignal, G200, 2 oz. copper	

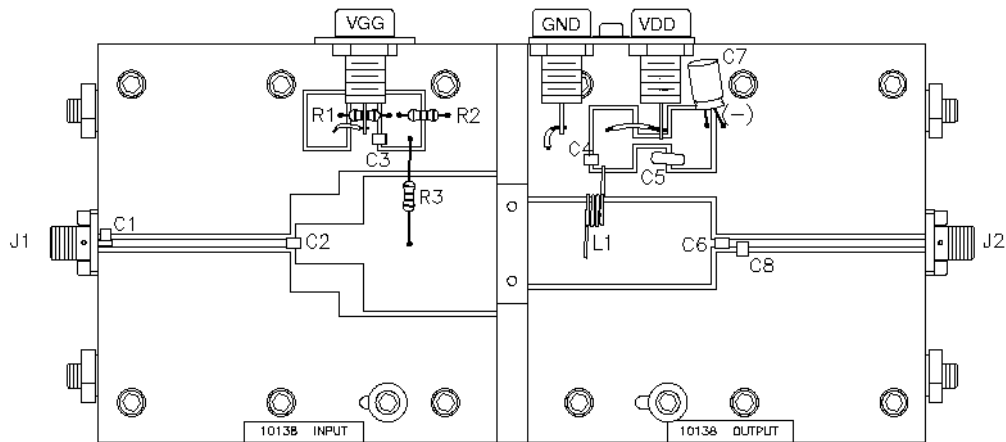

Placement Diagram (not to scale)

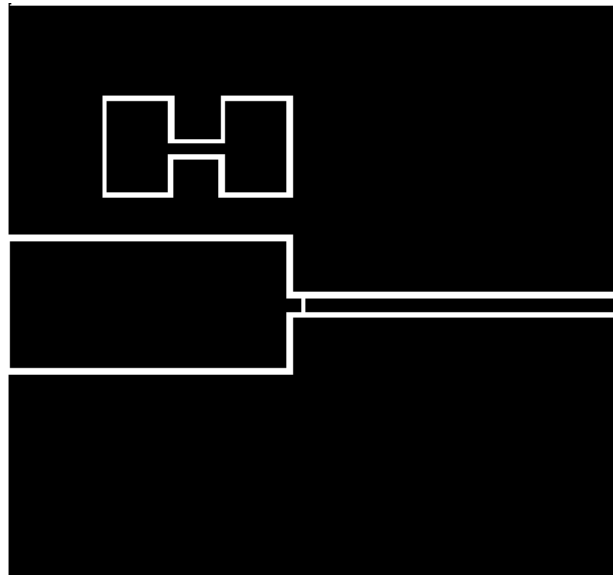
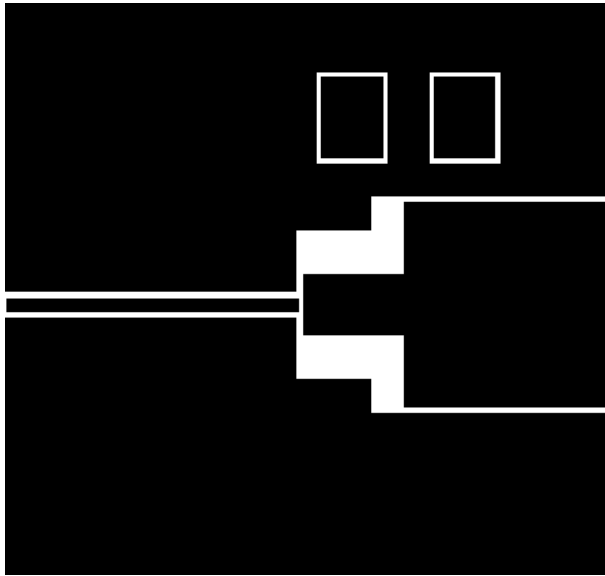

Artwork (not to scale)