

# IRF5803

HEXFET<sup>®</sup> Power MOSFET

- Ultra Low On-Resistance
- P-Channel MOSFET
- Surface Mount
- Available in Tape & Reel
- Low Gate Charge

$V_{DSS}$	$R_{DS(on)}$ max (m $\Omega$ )	$I_D$
<b>-40V</b>	112@ $V_{GS} = -10V$	-3.4A
	190@ $V_{GS} = -4.5V$	-2.7A

## Description

These P-channel HEXFET<sup>®</sup> Power MOSFETs from International Rectifier utilize advanced processing techniques to achieve the extremely low on-resistance per silicon area. This benefit provides the designer with an extremely efficient device for use in battery and load management applications.

The TSOP-6 package with its customized leadframe produces a HEXFET<sup>®</sup> power MOSFET with  $R_{DS(on)}$  60% less than a similar size SOT-23. This package is ideal for applications where printed circuit board space is at a premium. It's unique thermal design and  $R_{DS(on)}$  reduction enables a current-handling increase of nearly 300% compared to the SOT-23.

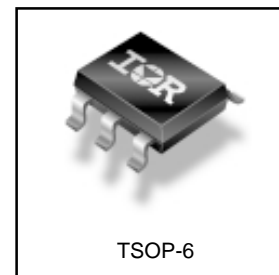
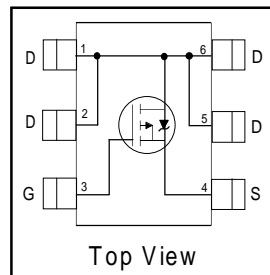

## Absolute Maximum Ratings

	Parameter	Max.	Units
$V_{DS}$	Drain- Source Voltage	-40	V
$I_D @ T_A = 25^\circ C$	Continuous Drain Current, $V_{GS} @ -10V$	-3.4	A
$I_D @ T_A = 70^\circ C$	Continuous Drain Current, $V_{GS} @ -10V$	-2.7	
$I_{DM}$	Pulsed Drain Current ①	-27	
$P_D @ T_A = 25^\circ C$	Power Dissipation ③	2.0	W
$P_D @ T_A = 70^\circ C$	Power Dissipation ③	1.3	
	Linear Derating Factor	16	mW/ $^\circ C$
$V_{GS}$	Gate-to-Source Voltage	$\pm 20$	V
$T_J, T_{STG}$	Junction and Storage Temperature Range	-55 to + 150	$^\circ C$

## Thermal Resistance

	Parameter	Max.	Units
$R_{\theta JA}$	Maximum Junction-to-Ambient ③	62.5	$^\circ C/W$

## Electrical Characteristics @ $T_J = 25^\circ\text{C}$ (unless otherwise specified)

	Parameter	Min.	Typ.	Max.	Units	Conditions
$V_{(BR)DSS}$	Drain-to-Source Breakdown Voltage	-40	—	—	V	$V_{GS} = 0V, I_D = -250\mu A$
$\Delta V_{(BR)DSS}/\Delta T_J$	Breakdown Voltage Temp. Coefficient	—	0.03	—	V/ $^\circ\text{C}$	Reference to $25^\circ\text{C}$ , $I_D = -1\text{mA}$
$R_{DS(on)}$	Static Drain-to-Source On-Resistance	—	—	112	m $\Omega$	$V_{GS} = -10V, I_D = -3.4$ ②
		—	—	190		$V_{GS} = -4.5V, I_D = -2.7A$ ②
$V_{GS(th)}$	Gate Threshold Voltage	-1.0	—	-3.0	V	$V_{DS} = V_{GS}, I_D = -250\mu A$
$g_{fs}$	Forward Transconductance	4.0	—	—	S	$V_{DS} = -10V, I_D = -3.4A$
$I_{DSS}$	Drain-to-Source Leakage Current	—	—	-10	$\mu A$	$V_{DS} = -32V, V_{GS} = 0V$
		—	—	-25		$V_{DS} = -32V, V_{GS} = 0V, T_J = 70^\circ\text{C}$
$I_{GSS}$	Gate-to-Source Forward Leakage	—	—	-100	nA	$V_{GS} = -20V$
	Gate-to-Source Reverse Leakage	—	—	100		$V_{GS} = 20V$
$Q_g$	Total Gate Charge	—	25	37	nC	$I_D = -3.4A$
$Q_{gs}$	Gate-to-Source Charge	—	4.5	6.8		$V_{DS} = -20V$
$Q_{gd}$	Gate-to-Drain ("Miller") Charge	—	3.5	5.3		$V_{GS} = -10V$
$t_{d(on)}$	Turn-On Delay Time	—	43	—	ns	$V_{DD} = -20V$ ②
$t_r$	Rise Time	—	550	—		$I_D = -1.0A$
$t_{d(off)}$	Turn-Off Delay Time	—	88	—		$R_G = 6.0\Omega$
$t_f$	Fall Time	—	50	—		$V_{GS} = -10V$
$C_{iss}$	Input Capacitance	—	1110	—	pF	$V_{GS} = 0V$
$C_{oss}$	Output Capacitance	—	93	—		$V_{DS} = -25V$
$C_{rss}$	Reverse Transfer Capacitance	—	73	—		$f = 100\text{kHz}$

## Source-Drain Ratings and Characteristics

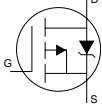
	Parameter	Min.	Typ.	Max.	Units	Conditions
$I_S$	Continuous Source Current (Body Diode)	—	—	-2.0	A	MOSFET symbol showing the integral reverse p-n junction diode. 
$I_{SM}$	Pulsed Source Current (Body Diode) ①	—	—	-27		
$V_{SD}$	Diode Forward Voltage	—	—	-1.2	V	$T_J = 25^\circ\text{C}, I_S = -2.0A, V_{GS} = 0V$ ②
$t_{rr}$	Reverse Recovery Time	—	27	40	ns	$T_J = 25^\circ\text{C}, I_F = -2.0A$
$Q_{rr}$	Reverse Recovery Charge	—	34	50	nC	$di/dt = -100A/\mu s$ ②

### Notes:

- ① Repetitive rating; pulse width limited by max. junction temperature.
- ② Pulse width  $\leq 400\mu s$ ; duty cycle  $\leq 2\%$ .
- ③ Surface mounted on 1 in square Cu board

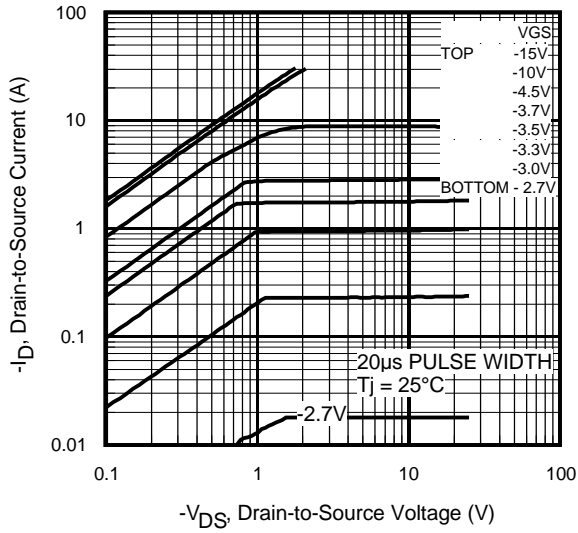

Fig 1. Typical Output Characteristics

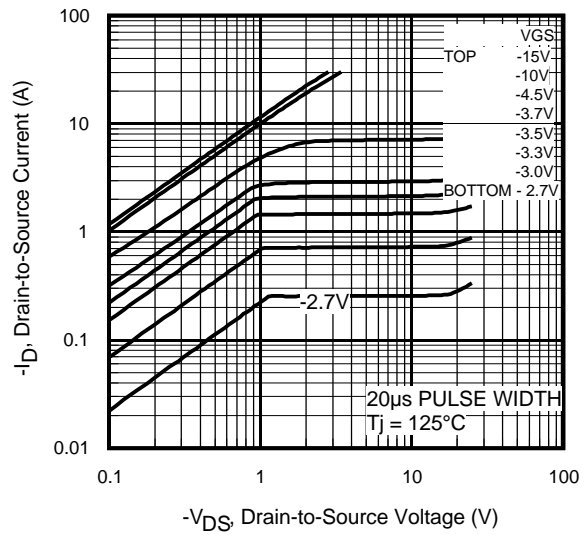

Fig 2. Typical Output Characteristics

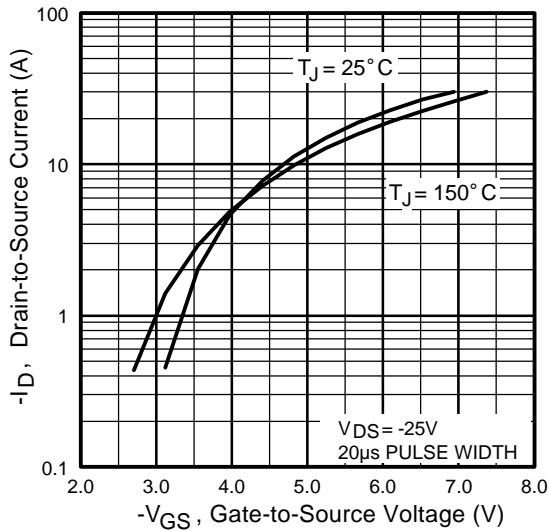

Fig 3. Typical Transfer Characteristics

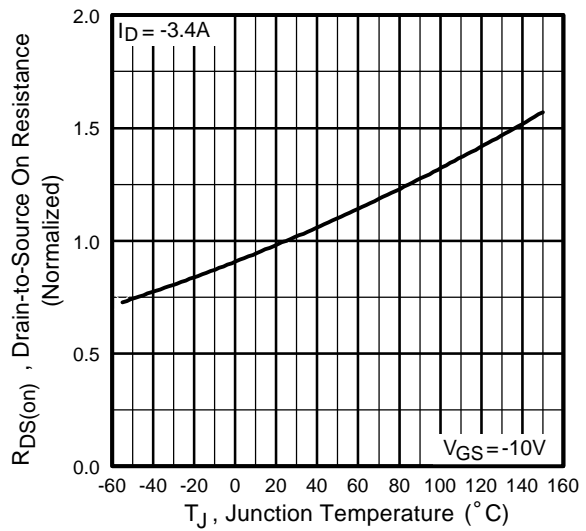
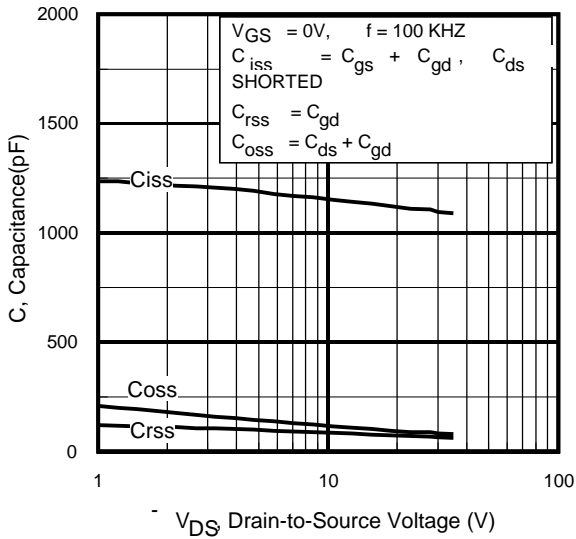
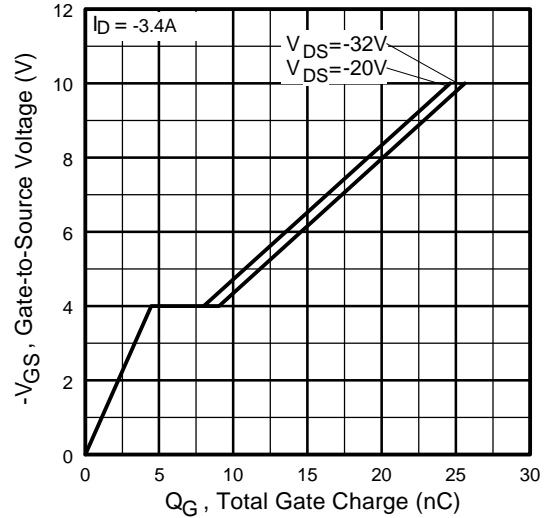

Fig 4. Normalized On-Resistance Vs. Temperature



**Fig 5.** Typical Capacitance Vs. Drain-to-Source Voltage



**Fig 6.** Typical Gate Charge Vs. Gate-to-Source Voltage

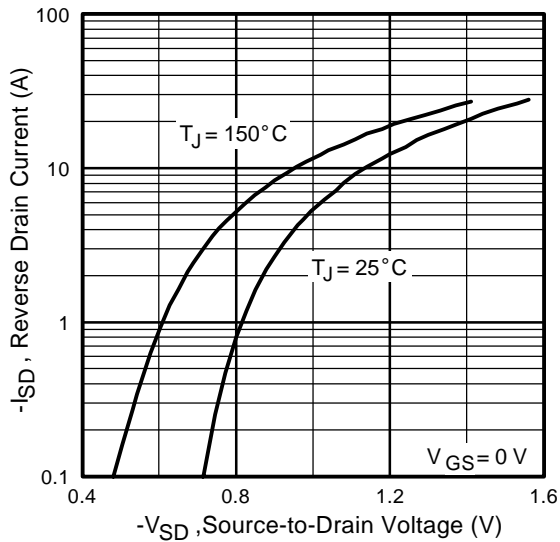

**Fig 7.** Typical Source-Drain Diode Forward Voltage

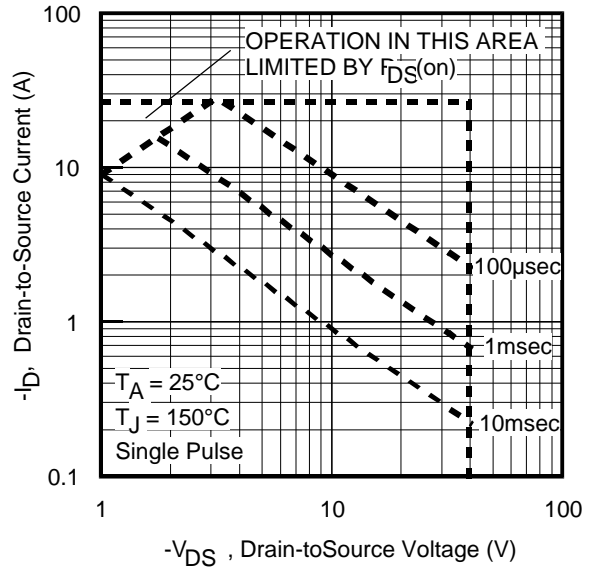

**Fig 8.** Maximum Safe Operating Area

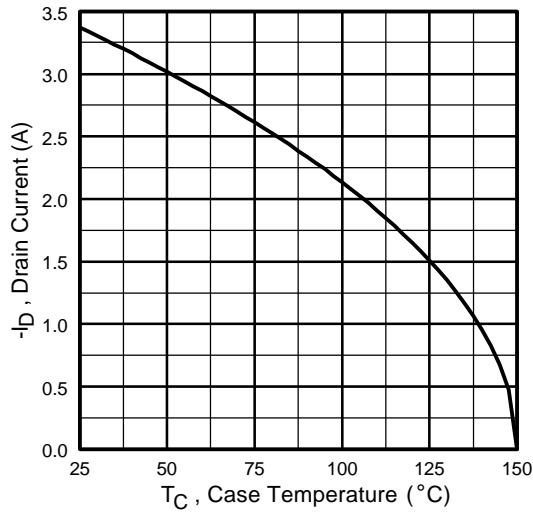

Fig 9. Maximum Drain Current Vs. Case Temperature

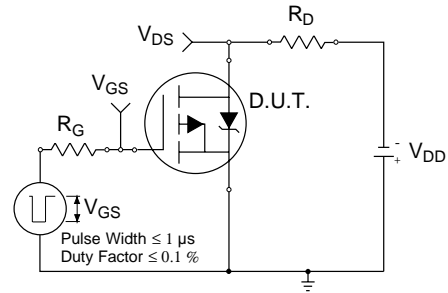

Fig 10a. Switching Time Test Circuit

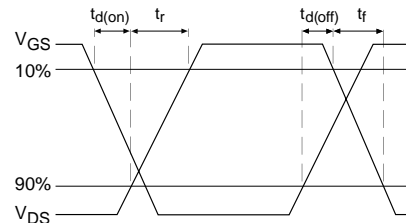

Fig 10b. Switching Time Waveforms

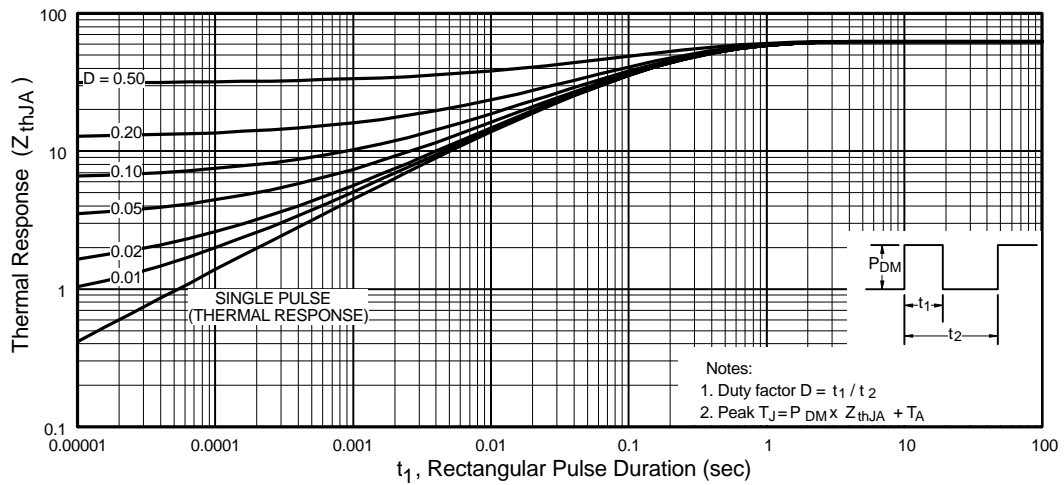
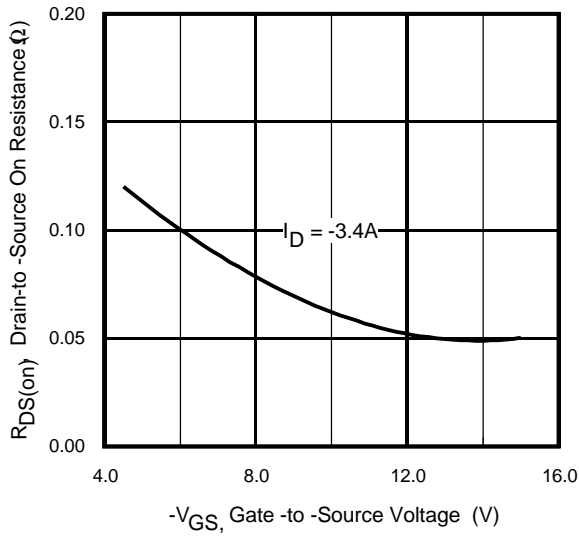
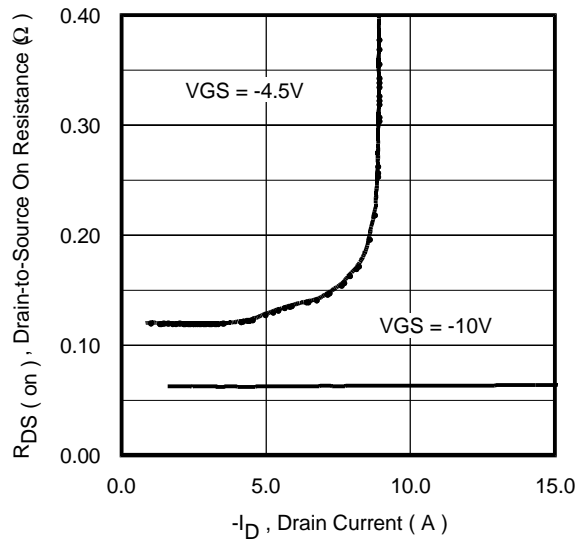

Fig 11. Maximum Effective Transient Thermal Impedance, Junction-to-Ambient



**Fig 12.** Typical On-Resistance Vs. Gate Voltage



**Fig 13.** Typical On-Resistance Vs. Drain Current

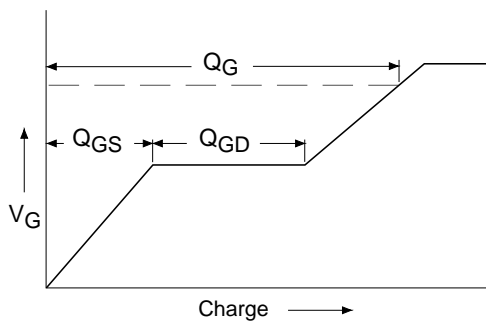

**Fig 14a.** Basic Gate Charge Waveform

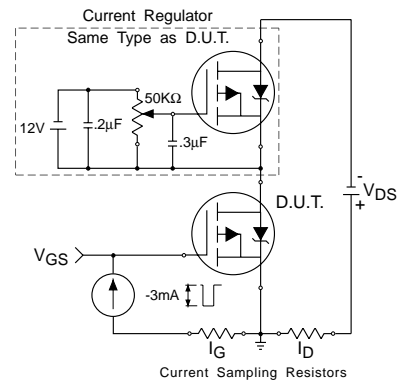

**Fig 14b.** Gate Charge Test Circuit

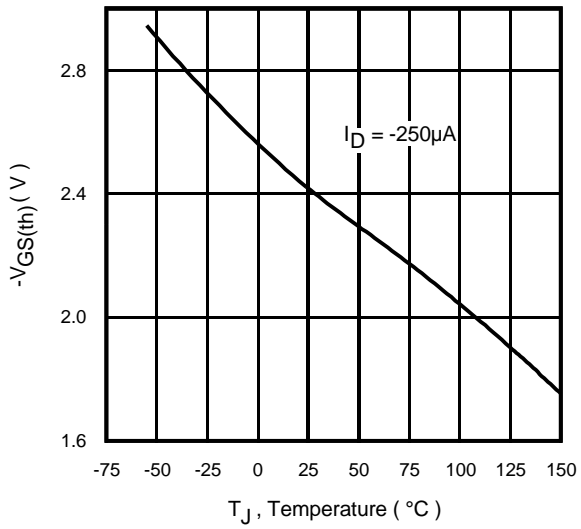

**Fig 15.** Typical Threshold Voltage Vs. Junction Temperature

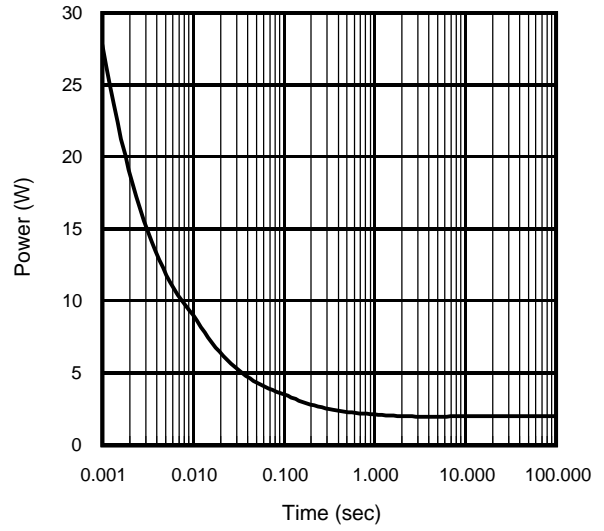
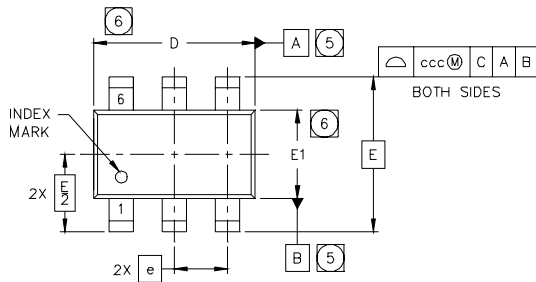

**Fig 16.** Typical Power Vs. Time

# IRF5803

International  
**IR** Rectifier

## TSOP-6 Package Outline



SYMBOL	MO-193AA DIMENSIONS					
	MILLIMETERS			INCHES		
	MIN	NOM	MAX	MIN	NOM	MAX
A	---	---	1.10	----	----	.0433
A1	0.01	---	0.10	.0004	---	.0039
A2	0.80	0.90	1.00	.0315	.0354	.0393
b	0.25	---	0.50	.0099	---	.0196
c	0.10	---	0.26	.004	---	.010
D	2.90	3.00	3.10	.115	.118	.122
E	2.75 BSC			.108 BSC		
E1	1.30	1.50	1.70	.052	.059	.066
e	1.00 BSC			.039 BSC		
L	0.20	0.40	0.60	.0079	.0157	.0236
L1	0.30 BSC			.0118 BSC		
θ	0°	---	8°	0°	---	8°
aaa	0.10			.004		
bbb	0.15			.006		
ccc	0.25			.010		

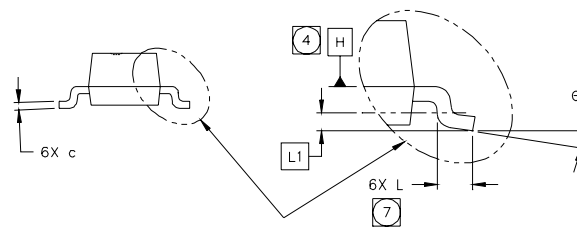
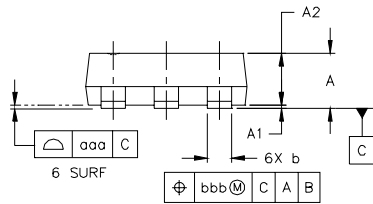

## TSOP-6 Part Marking Information

EXAMPLE: THIS IS AN SI3443DV

WW = (1-26) IF PRECEDED BY LAST DIGIT OF CALENDAR YEAR

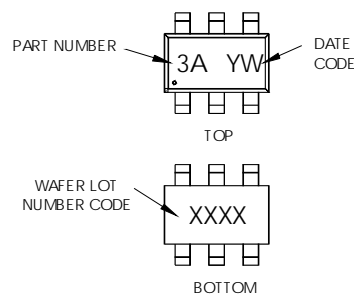

YEAR	Y	WORK WEEK	W
2001	1	01	A
2002	2	02	B
2003	3	03	C
2004	4	04	D
2005	5		
1996	6		
1997	7		
1998	8		
1999	9		
2000	0	24	X
		25	Y
		26	Z

PART NUMBER CODE REFERENCE:

- 3A = SI3443DV
- 3B = IRF5800
- 3C = IRF5850
- 3D = IRF5851
- 3E = IRF5852
- 3I = IRF5805
- 3J = IRF5806

DATE CODE EXAMPLES:

- YWW = 9603 = 6C
- YWW = 9632 = FF

WW = (27-52) IF PRECEDED BY A LETTER

YEAR	Y	WORK WEEK	W
2001	A	27	A
2002	B	28	B
2003	C	29	C
2004	D	30	D
2005	E		
1996	F		
1997	G		
1998	H		
1999	J		
2000	K	50	X
		51	Y
		52	Z



## TSOP-6 Tape & Reel Information

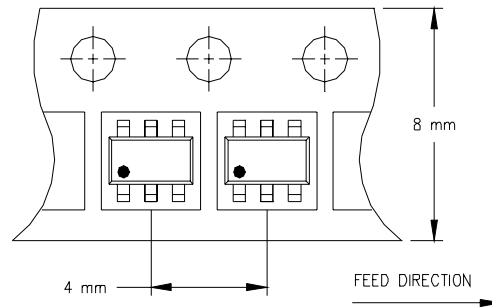

NOTES:

1. OUTLINE CONFORMS TO EIA-481 & EIA-541.

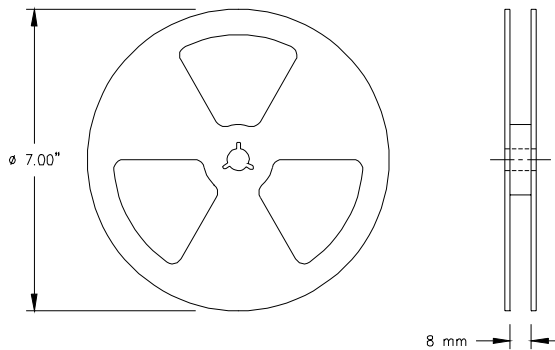

NOTES:

1. OUTLINE CONFORMS TO EIA-481 & EIA-541.

Data and specifications subject to change without notice.  
This product has been designed and qualified for the consumer market.  
Qualification Standards can be found on IR's Web site.

International  
**IR** Rectifier

**IR WORLD HEADQUARTERS:** 233 Kansas St., El Segundo, California 90245, USA Tel: (310) 252-7105  
TAC Fax: (310) 252-7903

Visit us at [www.irf.com](http://www.irf.com) for sales contact information.03/01