

FEATURES

High-Performance Member of Pin-Compatible TxDAC Product Family
Excellent Spurious-Free Dynamic Range Performance
SNR @ 5 MHz Output, 125 MSPS: 65 dB
Two's Complement or Straight Binary Data Format
Differential Current Outputs: 2 mA to 20 mA
Power Dissipation: 135 mW @ 3.3 V
Power-Down Mode: 15 mW @ 3.3 V
On-Chip 1.20 V Reference
CMOS-Compatible Digital Interface
Package: 28-Lead SOIC and TSSOP Packages
Edge-Triggered Latches

APPLICATIONS

Wideband Communication Transmit Channel:
Direct IF
Base Stations
Wireless Local Loop
Digital Radio Link
Direct Digital Synthesis (DDS)
Instrumentation

PRODUCT DESCRIPTION

The AD9740 is a 10-bit resolution, wideband, third generation member of the TxDAC series of high-performance, low power CMOS digital-to-analog converters (DACs). The TxDAC family, consisting of pin-compatible 8-, 10-, 12-, and 14-bit DACs, is specifically optimized for the transmit signal path of communication systems. All of the devices share the same interface options, small outline package, and pinout, providing an upward or downward component selection path based on performance, resolution, and cost. The AD9740 offers exceptional ac and dc performance while supporting update rates up to 165 MSPS.

The AD9740's low power dissipation makes it well suited for portable and low power applications. Its power dissipation can be further reduced to a mere 60 mW with a slight degradation in performance by lowering the full-scale current output. Also, a power-down mode reduces the standby power dissipation to approximately 15 mW. A segmented current source architecture is combined with a proprietary switching technique to reduce spurious components and enhance dynamic performance. Edge-triggered input latches and a 1.2 V temperature compensated band gap reference have been integrated to provide a complete monolithic DAC solution. The digital inputs support 3 V CMOS logic families.

TxDAC is a registered trademark of Analog Devices, Inc.

*Protected by U.S. Patent Numbers 5568145, 5689257, and 5703519.

REV. 0

Information furnished by Analog Devices is believed to be accurate and reliable. However, no responsibility is assumed by Analog Devices for its use, nor for any infringements of patents or other rights of third parties that may result from its use. No license is granted by implication or otherwise under any patent or patent rights of Analog Devices.

FUNCTIONAL BLOCK DIAGRAM

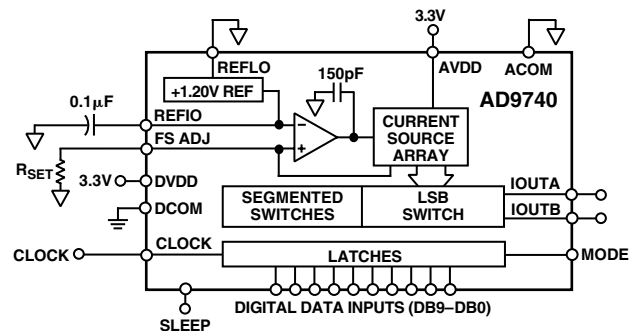

PRODUCT HIGHLIGHTS

1. The AD9740 is the 10-bit member of the pin-compatible TxDAC family that offers excellent INL and DNL performance.
2. Data input supports two's complement or straight binary data coding.
3. High-speed, single-ended CMOS clock input supports 165 MSPS conversion rate.
4. Low power: Complete CMOS DAC function operates on 135 mW from a 3.0 V to 3.6 V single supply. The DAC full-scale current can be reduced for lower power operation, and a sleep mode is provided for low power idle periods.
5. On-chip voltage reference: The AD9740 includes a 1.2 V temperature-compensated band gap voltage reference.
6. Industry standard 28-lead SOIC and TSSOP packages.

AD9740

DC SPECIFICATIONS (T_{MIN} to T_{MAX}, AVDD = 3.3 V, DVDD = 3.3 V, I_{OUTFS} = 20 mA, unless otherwise noted.)

Parameter	Min	Typ	Max	Unit
RESOLUTION	10			Bits
DC ACCURACY ¹				
Integral Linearity Error (INL)	-0.7	±0.15	+0.7	LSB
Differential Nonlinearity (DNL)	-0.5	±0.12	+0.5	LSB
ANALOG OUTPUT				
Offset Error	-0.02		+0.02	% of FSR
Gain Error (Without Internal Reference)	-2	±0.1	+2	% of FSR
Gain Error (With Internal Reference)	-2	±0.1	+2	% of FSR
Full-Scale Output Current ²	2.0		20.0	mA
Output Compliance Range	-1.0		+1.25	V
Output Resistance		100		kΩ
Output Capacitance		5		pF
REFERENCE OUTPUT				
Reference Voltage	1.14	1.20	1.26	V
Reference Output Current ³		100		nA
REFERENCE INPUT				
Input Compliance Range	0.1		1.25	V
Reference Input Resistance (Ext. Ref)		1		MΩ
Small Signal Bandwidth		0.5		MHz
TEMPERATURE COEFFICIENTS				
Offset Drift		0		ppm of FSR/°C
Gain Drift (Without Internal Reference)		±50		ppm of FSR/°C
Gain Drift (With Internal Reference)		±100		ppm of FSR/°C
Reference Voltage Drift		±50		ppm/°C
POWER SUPPLY				
Supply Voltages				
AVDD	2.7	3.3	3.6	V
DVDD	2.7	3.3	3.6	V
Analog Supply Current (I _{AVDD})		33	36	mA
Digital Supply Current (I _{DVDD}) ⁴		8	9	mA
Supply Current Sleep Mode (I _{AVDD})		5	6	mA
Power Dissipation ⁴		135	145	mW
Power Dissipation ⁵		145		mW
Power Supply Rejection Ratio—AVDD ⁶	-1		+1	% of FSR/V
Power Supply Rejection Ratio—DVDD ⁶	-0.04		+0.04	% of FSR/V
OPERATING RANGE	-40		+85	°C

NOTES

¹Measured at I_{OUTA}, driving a virtual ground.

²Nominal full-scale current, I_{OUTFS} is 32 times the I_{REF} current.

³An external buffer amplifier with input bias current <100 nA should be used to drive any external load.

⁴Measured at f_{CLOCK} = 25 MSPS and f_{OUT} = 1.0 MHz.

⁵Measured as unbuffered voltage output with I_{OUTFS} = 20 mA and 50 Ω R_{LOAD} at I_{OUTA} and I_{OUTB}, f_{CLOCK} = 100 MSPS and f_{OUT} = 40 MHz.

⁶±5% power supply variation.

Specifications subject to change without notice.

DYNAMIC SPECIFICATIONS (T_{MIN} to T_{MAX} , AVDD = 3.3 V, DVDD = 3.3 V, $I_{OUTFS} = 20$ mA, Differential Transformer Coupled Output, 50 Ω Doubly terminated, unless otherwise noted.)

Parameter	Min	Typ	Max	Unit
DYNAMIC PERFORMANCE				
Maximum Output Update Rate (f_{CLOCK})	165			MSPS
Output Settling Time (t_{ST}) (to 0.1%) ¹		11		ns
Output Propagation Delay (t_{PD})		1		ns
Glitch Impulse		5		pV-s
Output Rise Time (10% to 90%) ¹		2.5		ns
Output Fall Time (10% to 90%) ¹		2.5		ns
Output Noise ($I_{OUTFS} = 20$ mA) ²		50		pA/ \sqrt{Hz}
Output Noise ($I_{OUTFS} = 2$ mA) ²		30		pA/ \sqrt{Hz}
Noise Spectral Density ³		-143		dBm/Hz
AC LINEARITY				
Spurious-Free Dynamic Range to Nyquist				
$f_{CLOCK} = 25$ MSPS; $f_{OUT} = 1.00$ MHz	71	79		dBc
0 dBFS Output				
-6 dBFS Output				
-12 dBFS Output				
-18 dBFS Output		61		dBc
$f_{CLOCK} = 65$ MSPS; $f_{OUT} = 1.00$ MHz		84		dBc
$f_{CLOCK} = 65$ MSPS; $f_{OUT} = 2.51$ MHz		80		dBc
$f_{CLOCK} = 65$ MSPS; $f_{OUT} = 10$ MHz		78		dBc
$f_{CLOCK} = 65$ MSPS; $f_{OUT} = 15$ MHz		76		dBc
$f_{CLOCK} = 65$ MSPS; $f_{OUT} = 25$ MHz		75		dBc
$f_{CLOCK} = 165$ MSPS; $f_{OUT} = 21$ MHz		70		dBc
$f_{CLOCK} = 165$ MSPS; $f_{OUT} = 41$ MHz		60		dBc
Spurious-Free Dynamic Range within a Window				
$f_{CLOCK} = 25$ MSPS; $f_{OUT} = 1.00$ MHz; 2 MHz Span	80			dBc
$f_{CLOCK} = 50$ MSPS; $f_{OUT} = 5.02$ MHz; 2 MHz Span				
$f_{CLOCK} = 65$ MSPS; $f_{OUT} = 5.03$ MHz; 2.5 MHz Span				
$f_{CLOCK} = 125$ MSPS; $f_{OUT} = 5.04$ MHz; 4 MHz Span				
Total Harmonic Distortion				
$f_{CLOCK} = 25$ MSPS; $f_{OUT} = 1.00$ MHz		-79	-71	dBc
$f_{CLOCK} = 50$ MSPS; $f_{OUT} = 2.00$ MHz		-77		dBc
$f_{CLOCK} = 65$ MSPS; $f_{OUT} = 2.00$ MHz		-77		dBc
$f_{CLOCK} = 125$ MSPS; $f_{OUT} = 2.00$ MHz		-77		dBc
Signal-to-Noise Ratio				
$f_{CLOCK} = 65$ MSPS; $f_{OUT} = 5$ MHz; $I_{OUTFS} = 20$ mA		70		dB
$f_{CLOCK} = 65$ MSPS; $f_{OUT} = 5$ MHz; $I_{OUTFS} = 5$ mA		81		dB
$f_{CLOCK} = 125$ MSPS; $f_{OUT} = 5$ MHz; $I_{OUTFS} = 20$ mA		65		dB
$f_{CLOCK} = 125$ MSPS; $f_{OUT} = 5$ MHz; $I_{OUTFS} = 5$ mA		76		dB
$f_{CLOCK} = 165$ MSPS; $f_{OUT} = 5$ MHz; $I_{OUTFS} = 20$ mA		64		dB
$f_{CLOCK} = 165$ MSPS; $f_{OUT} = 5$ MHz; $I_{OUTFS} = 5$ mA		71		dB
Multitone Power Ratio (8 Tones at 400 kHz Spacing)				
$f_{CLOCK} = 78$ MSPS; $f_{OUT} = 15.0$ MHz to 18.2 MHz				
0 dBFS Output		65		dBc
-6 dBFS Output		66		dBc
-12 dBFS Output		60		dBc
-18 dBFS Output		55		dBc

NOTES

¹Measured single-ended into 50 Ω load.

²Output noise is measured with a full-scale output set to 20 mA with no conversion activity. It is a measure of the thermal noise only.

³Noise spectral density is the average noise power normalized to a 1 Hz bandwidth, with the DAC converting and producing an output tone.

Specifications subject to change without notice.

AD9740

DIGITAL SPECIFICATIONS (T_{MIN} to T_{MAX} , AVDD = 3.3 V, DVDD = 3.3 V, I_{OUTFS} = 20 mA, unless otherwise noted.)

Parameter	Min	Typ	Max	Unit
DIGITAL INPUTS				
Logic "1" Voltage	2.1	3		V
Logic "0" Voltage		0	0.9	V
Logic "1" Current	-10		+10	μ A
Logic "0" Current	-10		+10	μ A
Input Capacitance		5		pF
Input Setup Time (t_S)	2.0			ns
Input Hold Time (t_H)	1.5			ns
Latch Pulsewidth (t_{LPW})	1.5			ns

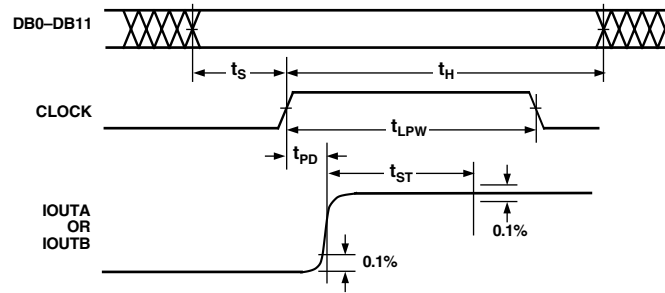

Figure 1. Timing Diagram

ABSOLUTE MAXIMUM RATINGS*

Parameter	With Respect to	Min Max		Unit
		Min	Max	
AVDD	ACOM	-0.3	+3.9	V
DVDD	DCOM	-0.3	+3.9	V
ACOM	DCOM	-0.3	+0.3	V
AVDD	DVDD	-3.9	+3.9	V
CLOCK, SLEEP	DCOM	-0.3	DVDD + 0.3	V
Digital Inputs	DCOM	-0.3	DVDD + 0.3	V
IOUTA, IOUTB	ACOM	-1.0	AVDD + 0.3	V
REFIO, REFLO, FSADJ	ACOM	-0.3	AVDD + 0.3	V
Junction Temperature			150	$^{\circ}$ C
Storage Temperature		-65	+150	$^{\circ}$ C
Lead Temperature (10 sec)			300	$^{\circ}$ C

*Stresses above those listed under Absolute Maximum Ratings may cause permanent damage to the device. This is a stress rating only; functional operation of the device at these or any other conditions above those indicated in the operational sections of this specification is not implied. Exposure to absolute maximum ratings for extended periods may effect device reliability.

CAUTION

ESD (electrostatic discharge) sensitive device. Electrostatic charges as high as 4000 V readily accumulate on the human body and test equipment and can discharge without detection. Although the AD9740 features proprietary ESD protection circuitry, permanent damage may occur on devices subjected to high-energy electrostatic discharges. Therefore, proper ESD precautions are recommended to avoid performance degradation or loss of functionality.

ORDERING GUIDE

Model	Temperature Range	Package Description	Package Options*
AD9740AR	-40 $^{\circ}$ C to +85 $^{\circ}$ C	28-Lead 300 Mil SOIC	R-28
AD9740ARU	-40 $^{\circ}$ C to +85 $^{\circ}$ C	28-Lead TSSOP	RU-28
AD9740-EB		Evaluation Board	

*R = Small Outline IC; RU = Thin Shrink Small Outline Package

THERMAL CHARACTERISTICS

Thermal Resistance

28-Lead 300-Mil SOIC

$$\theta_{JA} = 71.4^{\circ}\text{C/W}$$

28-Lead TSSOP

$$\theta_{JA} = 97.9^{\circ}\text{C/W}$$



PIN CONFIGURATION

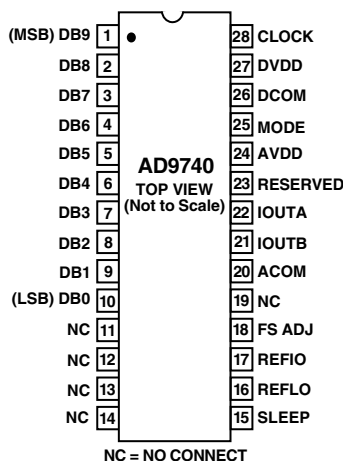

PIN FUNCTION DESCRIPTIONS

Pin No.	Mnemonic	Description
1	DB9	Most Significant Data Bit (MSB)
2–9	DB8–DB1	Data Bits 8–1
10	DB0	Least Significant Data Bit (LSB)
11–14	NC	No Internal Connection
15	SLEEP	Power-Down Control Input. Active high. Contains active pull-down circuit; it may be left unterminated if not used.
16	REFLO	Reference Ground when internal 1.2 V reference used. Connect to AVDD to disable internal reference.
17	REFIO	Reference Input/Output. Serves as reference input when internal reference disabled (i.e., tie REFLO to AVDD). Serves as 1.2 V reference output when internal reference activated (i.e., tie REFLO to AGND). Requires 0.1 μ F capacitor to AGND when internal reference activated.
18	FS ADJ	Full-Scale Current Output Adjust
19	NC	No Internal Connection
20	ACOM	Analog Common
21	IOUTB	Complementary DAC Current Output. Full-scale current when all data bits are 0s.
22	IOUTA	DAC Current Output. Full-scale current when all data bits are 1s.
23	RESERVED	Reserved. Do Not Connect to Common or Supply.
24	AVDD	Analog Supply Voltage (3.3 V)
25	MODE	Selects Input Data Format. Connect to DGND for straight binary, DVDD for two's complement.
26	DCOM	Digital Common
27	DVDD	Digital Supply Voltage (3.3 V)
28	CLOCK	Clock Input. Data latched on positive edge of clock.

Typical Performance Characteristics—AD9740

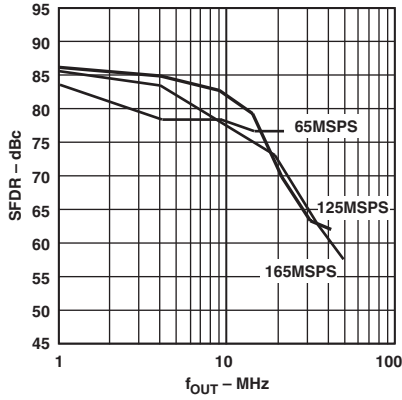

TPC 1. SFDR vs. f_{OUT} @ 0 dBFS

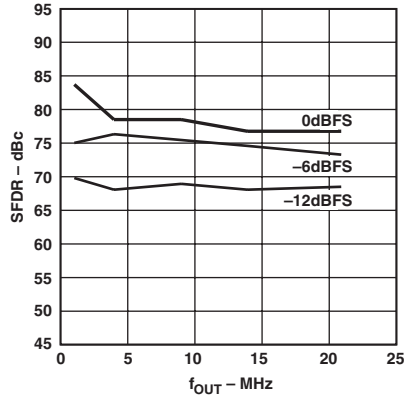

TPC 2. SFDR vs. f_{OUT} @ 65 MSPS

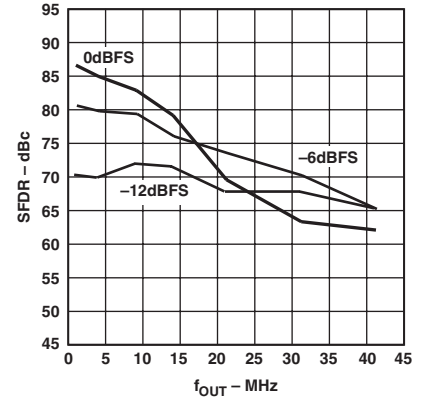

TPC 3. SFDR vs. f_{OUT} @ 125 MSPS

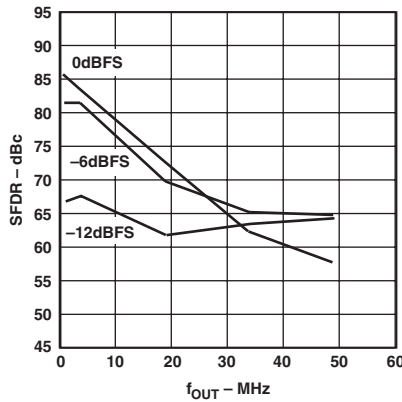

TPC 4. SFDR vs. f_{OUT} @ 165 MSPS

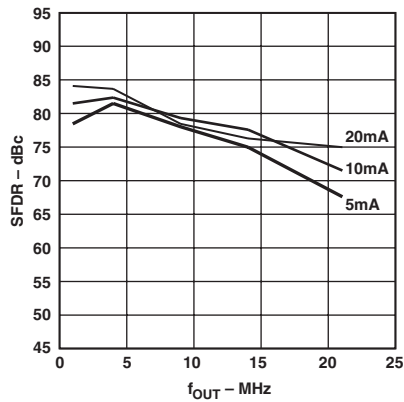

TPC 5. SFDR vs. f_{OUT} and I_{OUTFS} @ 65 MSPS and 0 dBFS

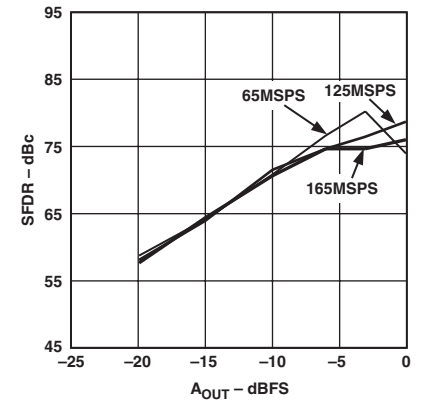

TPC 6. Single-Tone SFDR vs. A_{OUT} @ $f_{OUT} = f_{CLOCK}/11$

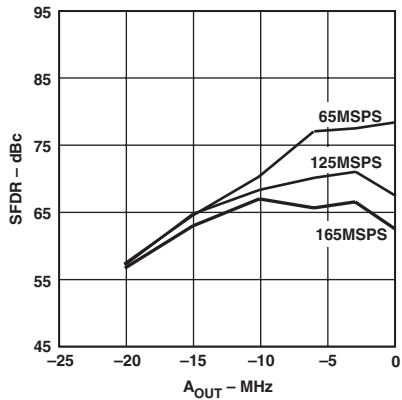

TPC 7. Single-Tone SFDR vs. A_{OUT} @ $f_{OUT} = f_{CLOCK}/5$

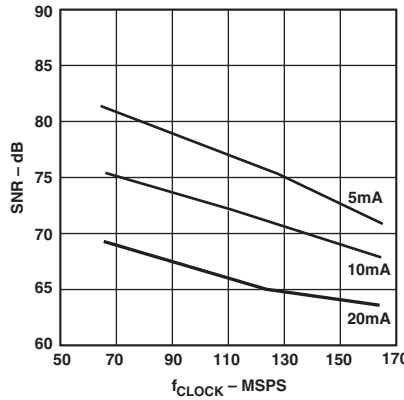

TPC 8. SNR vs. f_{CLOCK} and I_{OUTFS} @ $f_{OUT} = 5$ MHz and 0 dBFS

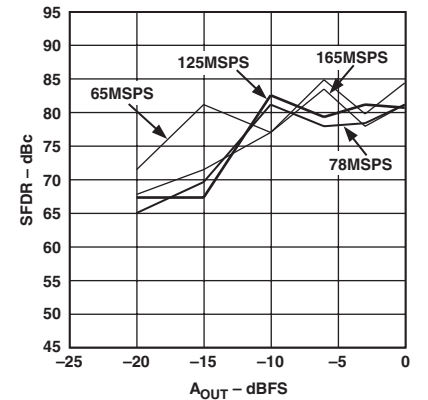

TPC 9. Dual-Tone IMD vs. A_{OUT} @ $f_{OUT} = f_{CLOCK}/7$

AD9740

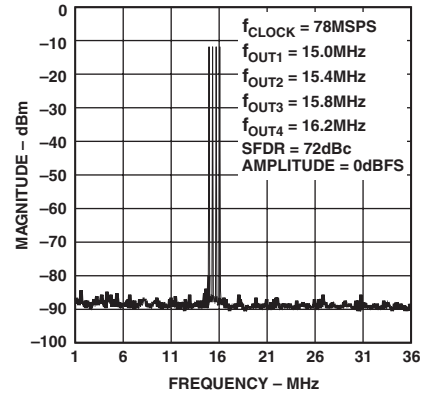
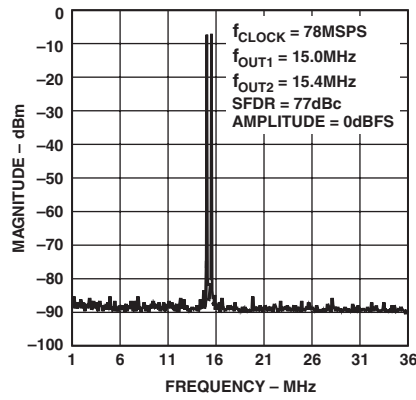
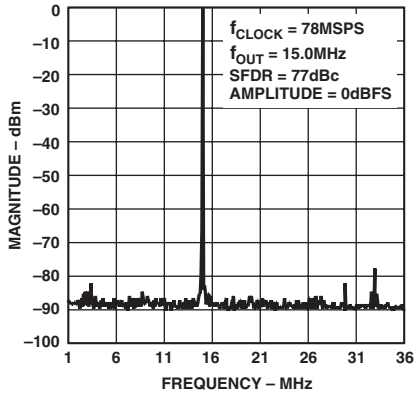
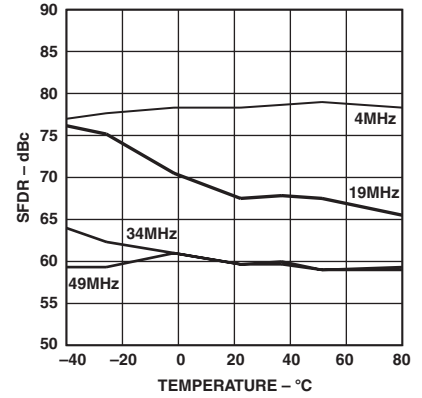
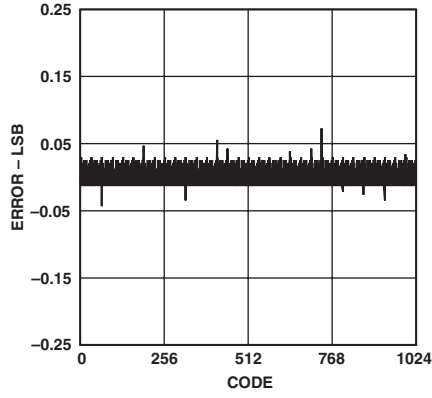
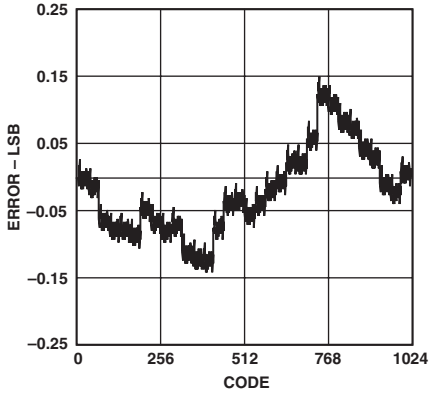

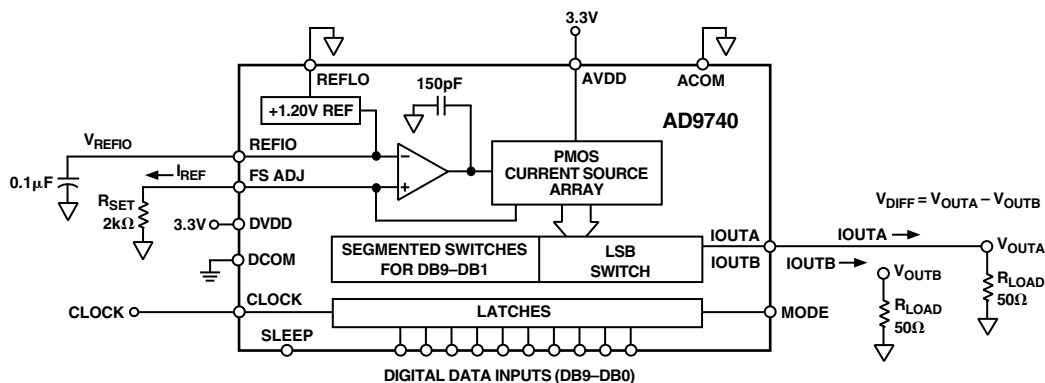

Figure 3. Simplified Block Diagram

FUNCTIONAL DESCRIPTION

Figure 3 shows a simplified block diagram of the AD9740. The AD9740 consists of a DAC, digital control logic, and full-scale output current control. The DAC contains a PMOS current source array capable of providing up to 20 mA of full-scale current (I_{OUTFS}). The array is divided into 31 equal currents that make up the 5 most significant bits (MSBs). The next 4 bits, or middle bits, consist of 15 equal current sources whose value is 1/16th of an MSB current source. The remaining LSBs are binary weighted fractions of the middle bits current sources. Implementing the middle and lower bits with current sources, instead of an R-2R ladder, enhances its dynamic performance for multitone or low amplitude signals and helps maintain the DAC's high output impedance (i.e., >100 k Ω).

All of these current sources are switched to one or the other of the two output nodes (i.e., IOUTA or IOUTB) via PMOS differential current switches. The switches are based on the architecture that was pioneered in the AD9764 family, with further refinements to reduce distortion contributed by the switching transient. This switch architecture also reduces various timing errors and provides matching complementary drive signals to the inputs of the differential current switches.

The analog and digital sections of the AD9740 have separate power supply inputs (i.e., AVDD and DVDD) that can operate independently over a 3.0 V to 3.6 V range. The digital section, which is capable of operating up to a 165 MSPS clock rate, consists of edge-triggered latches and segment decoding logic circuitry. The analog section includes the PMOS current sources, the associated differential switches, a 1.2 V band gap voltage reference, and a reference control amplifier.

The DAC full-scale output current is regulated by the reference control amplifier and can be set from 2 mA to 20 mA via an external resistor, R_{SET} , connected to the full-scale adjust (FSADJ) pin. The external resistor, in combination with both the reference control amplifier and voltage reference, V_{REFIO} , sets the reference current I_{REF} , which is replicated to the segmented current sources with the proper scaling factor. The full-scale current, I_{OUTFS} , is 32 times I_{REF} .

REFERENCE OPERATION

The AD9740 contains an internal 1.2 V band gap reference. The internal reference can be disabled by raising REFLO to AVDD. It can also be easily overridden by an external reference with no effect on performance. REFIO serves as either an input or output depending on whether the internal or an external reference is used. To use the internal reference, simply decouple the REFIO pin to ACOM with a 0.1 μ F capacitor and connect REFLO to ACOM with a resistance less than 5 Ω . The internal reference voltage will be present at REFIO. If the voltage at REFIO is to be used anywhere else in the circuit, an external buffer amplifier with an input bias current of less than 100 nA should be used. An example of the use of the internal reference is given in Figure 4.

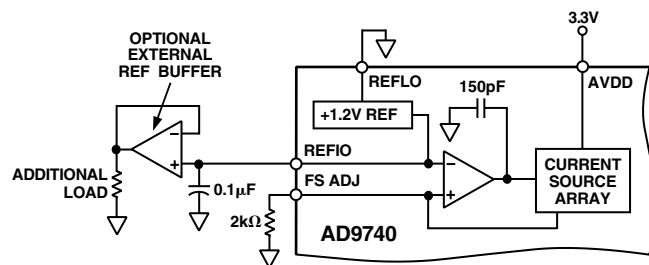

Figure 4. Internal Reference Configuration

An external reference can be applied to REFIO as shown in Figure 5. The external reference may provide either a fixed reference voltage to enhance accuracy and drift performance or a varying reference voltage for gain control. Note that the 0.1 μ F compensation capacitor is not required since the internal reference is overridden, and the relatively high input impedance of REFIO minimizes any loading of the external reference.

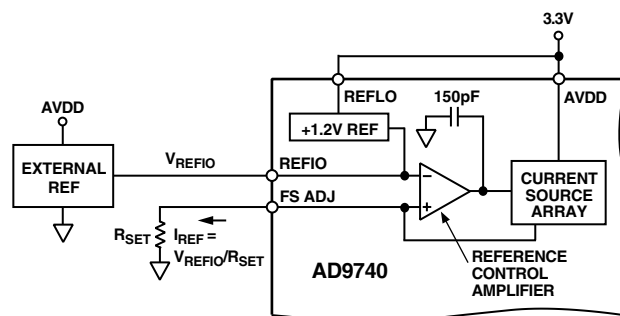

Figure 5. External Reference Configuration

AD9740

REFERENCE CONTROL AMPLIFIER

The AD9740 contains a control amplifier that is used to regulate the full-scale output current, I_{OUTFS} . The control amplifier is configured as a V-I converter as shown in Figure 4, so that its current output, I_{REF} , is determined by the ratio of the V_{REFIO} and an external resistor, R_{SET} , as stated in Equation 4. I_{REF} is copied to the segmented current sources with the proper scale factor to set I_{OUTFS} as stated in Equation 3.

The control amplifier allows a wide (10:1) adjustment span of I_{OUTFS} over a 2 mA to 20 mA range by setting I_{REF} between 62.5 μ A and 625 μ A. The wide adjustment span of I_{OUTFS} provides several benefits. The first relates directly to the power dissipation of the AD9740, which is proportional to I_{OUTFS} (refer to the Power Dissipation section). The second relates to the 20 dB adjustment, which is useful for system gain control purposes.

The small signal bandwidth of the reference control amplifier is approximately 500 kHz and can be used for low-frequency small signal multiplying applications.

DAC TRANSFER FUNCTION

Both DACs in the AD9740 provide complementary current outputs, I_{OUTA} and I_{OUTB} . I_{OUTA} will provide a near full-scale current output, I_{OUTFS} , when all bits are high (i.e., DAC CODE = 1023) while I_{OUTB} , the complementary output, provides no current. The current output appearing at I_{OUTA} and I_{OUTB} is a function of both the input code and I_{OUTFS} and can be expressed as:

$$I_{OUTA} = (DAC\ CODE / 1024) \times I_{OUTFS} \quad (1)$$

$$I_{OUTB} = (1023 - DAC\ CODE) / 1024 \times I_{OUTFS} \quad (2)$$

where $DAC\ CODE = 0$ to 1023 (i.e., decimal representation).

As mentioned previously, I_{OUTFS} is a function of the reference current I_{REF} , which is nominally set by a reference voltage, V_{REFIO} , and external resistor, R_{SET} . It can be expressed as:

$$I_{OUTFS} = 32 \times I_{REF} \quad (3)$$

where

$$I_{REF} = V_{REFIO} / R_{SET} \quad (4)$$

The two current outputs will typically drive a resistive load directly or via a transformer. If dc coupling is required, I_{OUTA} and I_{OUTB} should be directly connected to matching resistive loads, R_{LOAD} , that are tied to analog common, ACOM. Note, R_{LOAD} may represent the equivalent load resistance seen by I_{OUTA} or I_{OUTB} as would be the case in a doubly terminated 50 Ω or 75 Ω cable. The single-ended voltage output appearing at the I_{OUTA} and I_{OUTB} nodes is simply:

$$V_{OUTA} = I_{OUTA} \times R_{LOAD} \quad (5)$$

$$V_{OUTB} = I_{OUTB} \times R_{LOAD} \quad (6)$$

Note the full-scale value of V_{OUTA} and V_{OUTB} should not exceed the specified output compliance range to maintain specified distortion and linearity performance.

$$V_{DIFF} = (I_{OUTA} - I_{OUTB}) \times R_{LOAD} \quad (7)$$

Substituting the values of I_{OUTA} , I_{OUTB} , I_{REF} , and V_{DIFF} can be expressed as:

$$V_{DIFF} = \left\{ (2 \times DAC\ CODE - 1023) / 1024 \right\} \left(32 \times R_{LOAD} / R_{SET} \right) \times V_{REFIO} \quad (8)$$

These last two equations highlight some of the advantages of operating the AD9740 differentially. First, the differential operation will help cancel common-mode error sources associated with I_{OUTA} and I_{OUTB} , such as noise, distortion, and dc offsets. Second, the differential code dependent current and subsequent voltage, V_{DIFF} , is twice the value of the single-ended voltage output (i.e., V_{OUTA} or V_{OUTB}), thus providing twice the signal power to the load.

Note, the gain drift temperature performance for a single-ended (V_{OUTA} and V_{OUTB}) or differential output (V_{DIFF}) of the AD9740 can be enhanced by selecting temperature tracking resistors for R_{LOAD} and R_{SET} due to their ratiometric relationship as shown in Equation 8.

ANALOG OUTPUTS

The complementary current outputs in each DAC, I_{OUTA} and I_{OUTB} , may be configured for single-ended or differential operation. I_{OUTA} and I_{OUTB} can be converted into complementary single-ended voltage outputs, V_{OUTA} and V_{OUTB} , via a load resistor, R_{LOAD} , as described in the DAC Transfer Function section by Equations 5 through 8. The differential voltage, V_{DIFF} , existing between V_{OUTA} and V_{OUTB} can also be converted to a single-ended voltage via a transformer or differential amplifier configuration. The ac performance of the AD9740 is optimum and specified using a differential transformer coupled output in which the voltage swing at I_{OUTA} and I_{OUTB} is limited to ± 0.5 V.

The distortion and noise performance of the AD9740 can be enhanced when it is configured for differential operation. The common-mode error sources of both I_{OUTA} and I_{OUTB} can be significantly reduced by the common-mode rejection of a transformer or differential amplifier. These common-mode error sources include even-order distortion products and noise. The enhancement in distortion performance becomes more significant as the frequency content of the reconstructed waveform increases and/or its amplitude decreases. This is due to the first order cancellation of various dynamic common-mode distortion mechanisms, digital feedthrough, and noise.

Performing a differential-to-single-ended conversion via a transformer also provides the ability to deliver twice the reconstructed signal power to the load (i.e., assuming no source termination). Since the output currents of I_{OUTA} and I_{OUTB} are complementary, they become additive when processed differentially. A properly selected transformer will allow the AD9740 to provide the required power and voltage levels to different loads.

The output impedance of I_{OUTA} and I_{OUTB} is determined by the equivalent parallel combination of the PMOS switches associated with the current sources and is typically 100 k Ω in parallel with 5 pF. It is also slightly dependent on the output voltage (i.e., V_{OUTA} and V_{OUTB}) due to the nature of a PMOS device. As a result, maintaining I_{OUTA} and/or I_{OUTB} at a virtual ground via an I-V op amp configuration will result in the optimum dc linearity. Note the INL/DNL specifications for the AD9740 are measured with I_{OUTA} maintained at a virtual ground via an op amp.

IOUTA and IOUTB also have a negative and positive voltage compliance range that must be adhered to in order to achieve optimum performance. The negative output compliance range of -1.0 V is set by the breakdown limits of the CMOS process. Operation beyond this maximum limit may result in a breakdown of the output stage and affect the reliability of the AD9740.

The positive output compliance range is slightly dependent on the full-scale output current, I_{OUTFS} . It degrades slightly from its nominal 1.2 V for an $I_{OUTFS} = 20$ mA to 1.0 V for an $I_{OUTFS} = 2$ mA. The optimum distortion performance for a single-ended or differential output is achieved when the maximum full-scale signal at IOUTA and IOUTB does not exceed 0.5 V.

DIGITAL INPUTS

The AD9740's digital section consists of 10 input bit channels and a clock input. The 10-bit parallel data inputs follow standard positive binary coding where DB13 is the most significant bit (MSB) and DB0 is the least significant bit (LSB). IOUTA produces a full-scale output current when all data bits are at Logic 1. IOUTB produces a complementary output with the full-scale current split between the two outputs as a function of the input code.

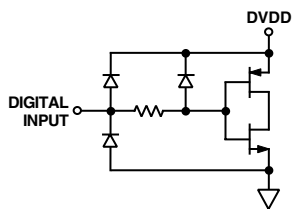

Figure 6. Equivalent Digital Input

The digital interface is implemented using an edge-triggered master/slave latch. The DAC output updates on the rising edge of the clock and is designed to support a clock rate as high as 165 MSPS. The clock can be operated at any duty cycle that meets the specified latch pulsewidth. The setup and hold times can also be varied within the clock cycle as long as the specified minimum times are met, although the location of these transition edges may affect digital feedthrough and distortion performance. Best performance is typically achieved when the input data transitions on the falling edge of a 50% duty cycle clock.

DAC TIMING

Input Clock and Data Timing Relationship

Dynamic performance in a DAC is dependent on the relationship between the position of the clock edges and the point in time at which the input data changes. The AD9740 is rising edge triggered, and so exhibits dynamic performance sensitivity when the data transition is close to this edge. In general, the goal when applying the AD9740 is to make the data transition close to the falling clock edge. This becomes more important as the sample rate increases. Figure 7 shows the relationship of SFDR to clock placement with different sample rates. Note that at the lower sample rates, more tolerance is allowed in clock placement, while at higher rates, more care must be taken.

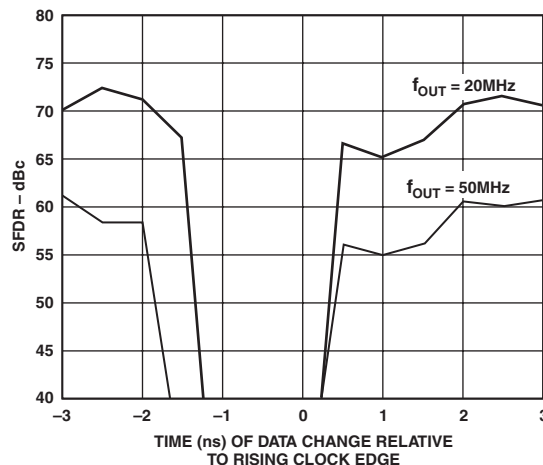

Figure 7. SFDR vs. Clock Placement @ $f_{OUT} = 20$ MHz and 50 MHz

Sleep Mode Operation

The AD9740 has a power-down function that turns off the output current and reduces the supply current to less than 4 mA over the specified supply range of 3.0 V to 3.6 V and temperature range. This mode can be activated by applying a logic level 1 to the SLEEP pin. The SLEEP pin logic threshold is equal to $0.5 \times AVDD$. This digital input also contains an active pull-down circuit that ensures the AD9740 remains enabled if this input is left disconnected. The AD9740 takes less than 50 ns to power down and approximately 5 μ s to power back up.

POWER DISSIPATION

The power dissipation, P_D , of the AD9740 is dependent on several factors that include:

- The power supply voltages ($AVDD$ and $DVDD$)
- The full-scale current output I_{OUTFS}
- The update rate f_{CLOCK}
- The reconstructed digital input waveform

The power dissipation is directly proportional to the analog supply current, I_{AVDD} , and the digital supply current, I_{DVDD} . I_{AVDD} is directly proportional to I_{OUTFS} as shown in Figure 8 and is insensitive to f_{CLOCK} . Conversely, I_{DVDD} is dependent on both the digital input waveform, f_{CLOCK} , and digital supply $DVDD$. Figure 9 shows I_{DVDD} as a function of full-scale sine wave output ratios (f_{OUT}/f_{CLOCK}) for various update rates with $DVDD = 3.3$ V.

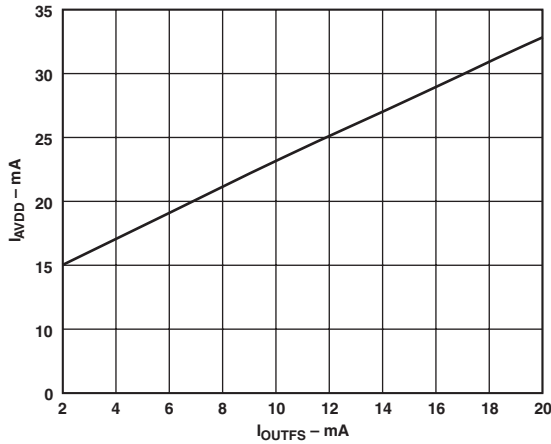

Figure 8. I_{AVDD} vs. I_{OUTFS}

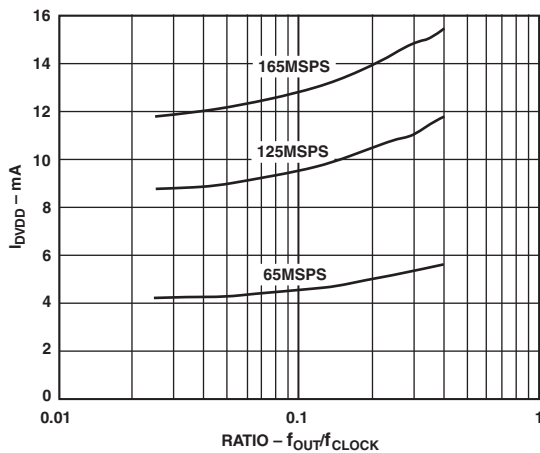

Figure 9. I_{DVDD} vs. Ratio @ $DVDD = 3.3 V$

APPLYING THE AD9740

Output Configurations

The following sections illustrate some typical output configurations for the AD9740. Unless otherwise noted, it is assumed that I_{OUTFS} is set to a nominal 20 mA. For applications requiring the optimum dynamic performance, a differential output configuration is suggested. A differential output configuration may consist of either an RF transformer or a differential op amp configuration. The transformer configuration provides the optimum high-frequency performance and is recommended for any application that allows ac coupling. The differential op amp configuration is suitable for applications requiring dc coupling, a bipolar output, signal gain, and/or level shifting, within the bandwidth of the chosen op amp.

A single-ended output is suitable for applications requiring a unipolar voltage output. A positive unipolar output voltage will result if I_{OUTA} and/or I_{OUTB} is connected to an appropriately sized load resistor, R_{LOAD} , referred to $ACOM$. This configuration may be more suitable for a single-supply system requiring a dc-coupled, ground referred output voltage. Alternatively, an amplifier could be configured as an I-V converter, thus converting I_{OUTA} or I_{OUTB} into a negative unipolar voltage. This configuration provides the best dc linearity since I_{OUTA} or I_{OUTB} is maintained at a virtual ground.

DIFFERENTIAL COUPLING USING A TRANSFORMER

An RF transformer can be used to perform a differential-to-single-ended signal conversion as shown in Figure 10. A differentially coupled transformer output provides the optimum distortion performance for output signals whose spectral content lies within the transformer's pass band. An RF transformer, such as the Mini-Circuits T1-1T, provides excellent rejection of common-mode distortion (i.e., even-order harmonics) and noise over a wide frequency range. It also provides electrical isolation and the ability to deliver twice the power to the load. Transformers with different impedance ratios may also be used for impedance matching purposes. Note that the transformer provides ac coupling only.

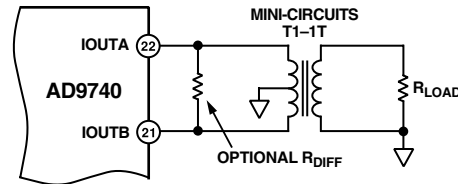

Figure 10. Differential Output Using a Transformer

The center tap on the primary side of the transformer must be connected to $ACOM$ to provide the necessary dc current path for both I_{OUTA} and I_{OUTB} . The complementary voltages appearing at I_{OUTA} and I_{OUTB} (i.e., V_{OUTA} and V_{OUTB}) swing symmetrically around $ACOM$ and should be maintained with the specified output compliance range of the AD9740. A differential resistor, R_{DIFF} , may be inserted in applications where the output of the transformer is connected to the load, R_{LOAD} , via a passive reconstruction filter or cable. R_{DIFF} is determined by the transformer's impedance ratio and provides the proper source termination that results in a low VSWR. Note that approximately half the signal power will be dissipated across R_{DIFF} .

DIFFERENTIAL COUPLING USING AN OP AMP

An op amp can also be used to perform a differential-to-single-ended conversion as shown in Figure 11. The AD9740 is configured with two equal load resistors, R_{LOAD} , of 25 Ω . The differential voltage developed across I_{OUTA} and I_{OUTB} is converted to a single-ended signal via the differential op amp configuration. An optional capacitor can be installed across I_{OUTA} and I_{OUTB} , forming a real pole in a low-pass filter. The addition of this capacitor also enhances the op amp's distortion performance by preventing the DACs high slewing output from overloading the op amp's input.

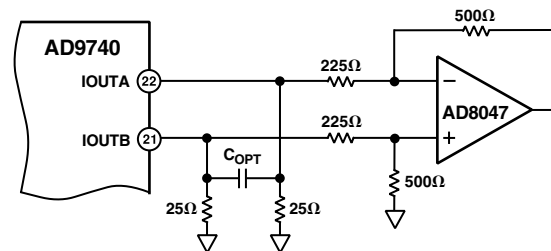

Figure 11. DC Differential Coupling Using an Op Amp

The common-mode rejection of this configuration is typically determined by the resistor matching. In this circuit, the differential op amp circuit using the AD8047 is configured to provide some additional signal gain. The op amp must operate off of a dual supply since its output is approximately $\pm 1.0 V$. A high-speed amplifier capable of preserving the differential performance of the

AD9740 while meeting other system level objectives (i.e., cost, power) should be selected. The op amp's differential gain, its gain setting resistor values, and full-scale output swing capabilities should all be considered when optimizing this circuit.

The differential circuit shown in Figure 12 provides the necessary level shifting required in a single-supply system. In this case, AVDD, which is the positive analog supply for both the AD9740 and the op amp, is also used to level shift the differential output of the AD9740 to midsupply (i.e., AVDD/2). The AD8041 is a suitable op amp for this application.

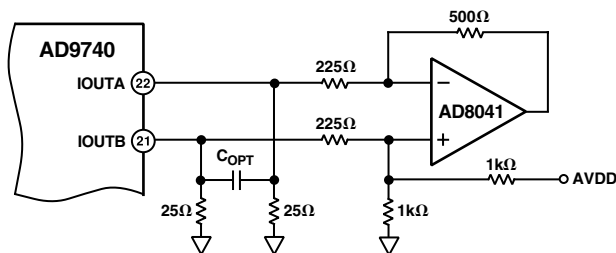

Figure 12. Single-Supply DC Differential Coupled Circuit

SINGLE-ENDED UNBUFFERED VOLTAGE OUTPUT

Figure 13 shows the AD9740 configured to provide a unipolar output range of approximately 0 V to 0.5 V for a doubly terminated 50 Ω cable, since the nominal full-scale current, I_{OUTFS}, of 20 mA flows through the equivalent R_{LOAD} of 25 Ω. In this case, R_{LOAD} represents the equivalent load resistance seen by IOUTA or IOUTB. The unused output (IOUTA or IOUTB) can be connected to ACOM directly or via a matching R_{LOAD}. Different values of I_{OUTFS} and R_{LOAD} can be selected as long as the positive compliance range is adhered to. One additional consideration in this mode is the integral nonlinearity (INL) as discussed in the Analog Output section of this data sheet. For optimum INL performance, the single-ended, buffered voltage output configuration is suggested.

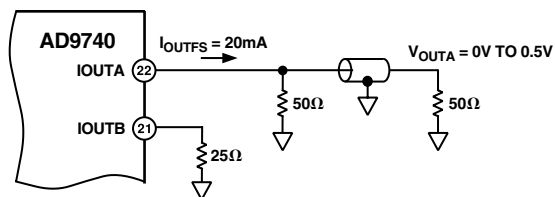

Figure 13. 0 V to 0.5 V Unbuffered Voltage Output

SINGLE-ENDED, BUFFERED VOLTAGE OUTPUT CONFIGURATION

Figure 14 shows a buffered single-ended output configuration in which the op amp U1 performs an I-V conversion on the AD9740 output current. U1 maintains IOUTA (or IOUTB) at a virtual ground, minimizing the nonlinear output impedance effect on the DAC's INL performance as discussed in the Analog Output section. Although this single-ended configuration typically provides the best dc linearity performance, its ac distortion performance at higher DAC update rates may be limited by U1's slew rate capabilities. U1 provides a negative unipolar output voltage and its full-scale output voltage is simply the product of R_{FB} and I_{OUTFS}. The full-scale output should be set within U1's voltage output swing capabilities by scaling I_{OUTFS} and/or R_{FB}. An improvement in ac distortion performance may result with a reduced I_{OUTFS} since U1 will be required to sink less signal current.

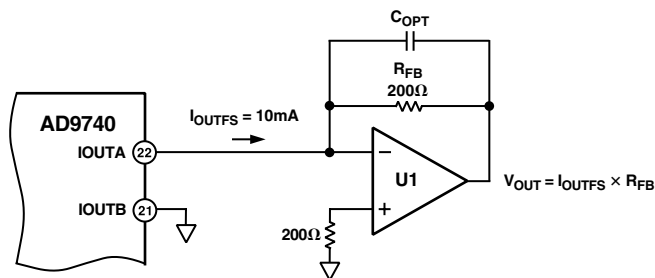

Figure 14. Unipolar Buffered Voltage Output

POWER AND GROUNDING CONSIDERATIONS, POWER SUPPLY REJECTION

Many applications seek high speed and high performance under less than ideal operating conditions. In these application circuits, the implementation and construction of the printed circuit board is as important as the circuit design. Proper RF techniques must be used for device selection, placement, and routing as well as power supply bypassing and grounding to ensure optimum performance. Figures 19 to 22 illustrate the recommended printed circuit board ground, power, and signal plane layouts that are implemented on the AD9740 evaluation board.

One factor that can measurably affect system performance is the ability of the DAC output to reject dc variations or ac noise superimposed on the analog or digital dc power distribution. This is referred to as the power supply rejection ratio. For dc variations of the power supply, the resulting performance of the DAC directly corresponds to a gain error associated with the DAC's full-scale current, I_{OUTFS}. AC noise on the dc supplies is common in applications where the power distribution is generated by a switching power supply. Typically, switching power supply noise will occur over the spectrum from tens of kHz to several MHz. The PSRR vs frequency of the AD9740 AVDD supply over this frequency range is shown in Figure 15.

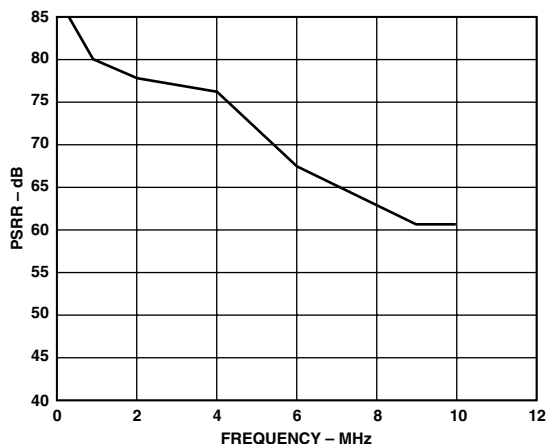

Figure 15. Power Supply Rejection Ratio

Note that the units in Figure 15 are given in units of (amps out/volts in). Noise on the analog power supply has the effect of modulating the internal switches, and therefore the output current. The voltage noise on AVDD, therefore, will be added in a nonlinear manner to the desired IOUT. Due to the relative different size of these switches, PSRR is very code dependent. This can produce a mixing effect that can modulate low-frequency power supply noise to higher frequencies. Worst-case PSRR for either one of the differential DAC outputs will occur when the

AD9740

full-scale current is directed toward that output. As a result, the PSRR measurement in Figure 15 represents a worst-case condition in which the digital inputs remain static and the full-scale output current of 20 mA is directed to the DAC output being measured.

An example serves to illustrate the effect of supply noise on the analog supply. Suppose a switching regulator with a switching frequency of 250 kHz produces 10 mV of noise and, for simplicity sake (i.e., ignore harmonics), all of this noise is concentrated at 250 kHz. To calculate how much of this undesired noise will appear as current noise superimposed on the DAC's full-scale current, I_{OUTFS} , one must determine the PSRR in dB using Figure 15 at 250 kHz. To calculate the PSRR for a given R_{LOAD} , such that the units of PSRR are converted from A/V to V/V, adjust the curve in Figure 15 by the scaling factor $20 \times \log(R_{LOAD})$. For instance, if R_{LOAD} is 50 Ω , the PSRR is reduced by 34 dB (i.e., PSRR of the DAC at 250 kHz which is 85 dB in Figure 15 becomes 51 dB V_{OUT}/V_{IN}).

Proper grounding and decoupling should be a primary objective in any high-speed, high resolution system. The AD9740 features separate analog and digital supply and ground pins to optimize the management of analog and digital ground currents in a system. In general, AVDD, the analog supply, should be decoupled to ACOM, the analog common, as close to the chip as physically possible. Similarly, DVDD, the digital supply, should be decoupled to DCOM as close to the chip as physically possible.

For those applications that require a single 3.3 V supply for both the analog and digital supplies, a clean analog supply may be generated using the circuit shown in Figure 16. The circuit consists of a differential LC filter with separate power supply and return lines. Lower noise can be attained by using low ESR type electrolytic and tantalum capacitors.

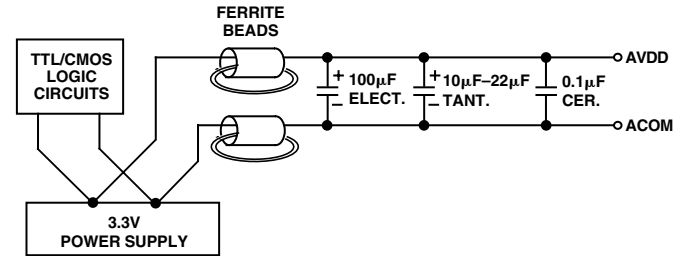

Figure 16. Differential LC Filter for Single 3.3 V Applications

EVALUATION BOARD

General Description

The TxDAC family evaluation board allows for easy set up and testing of any TxDAC product in the 28-lead SOIC package. Careful attention to layout and circuit design combined with a prototyping area allow the user to evaluate the AD9740 easily and effectively in any application where high resolution, high-speed conversion is required.

This board allows the user the flexibility to operate the AD9740 in various configurations. Possible output configurations include transformer coupled, resistor terminated, and single and differential outputs. The digital inputs are designed to be driven from various word generators, with the on-board option to add a resistor network for proper load termination. Provisions are also made to operate the AD9740 with either the internal or external reference or to exercise the power-down feature.

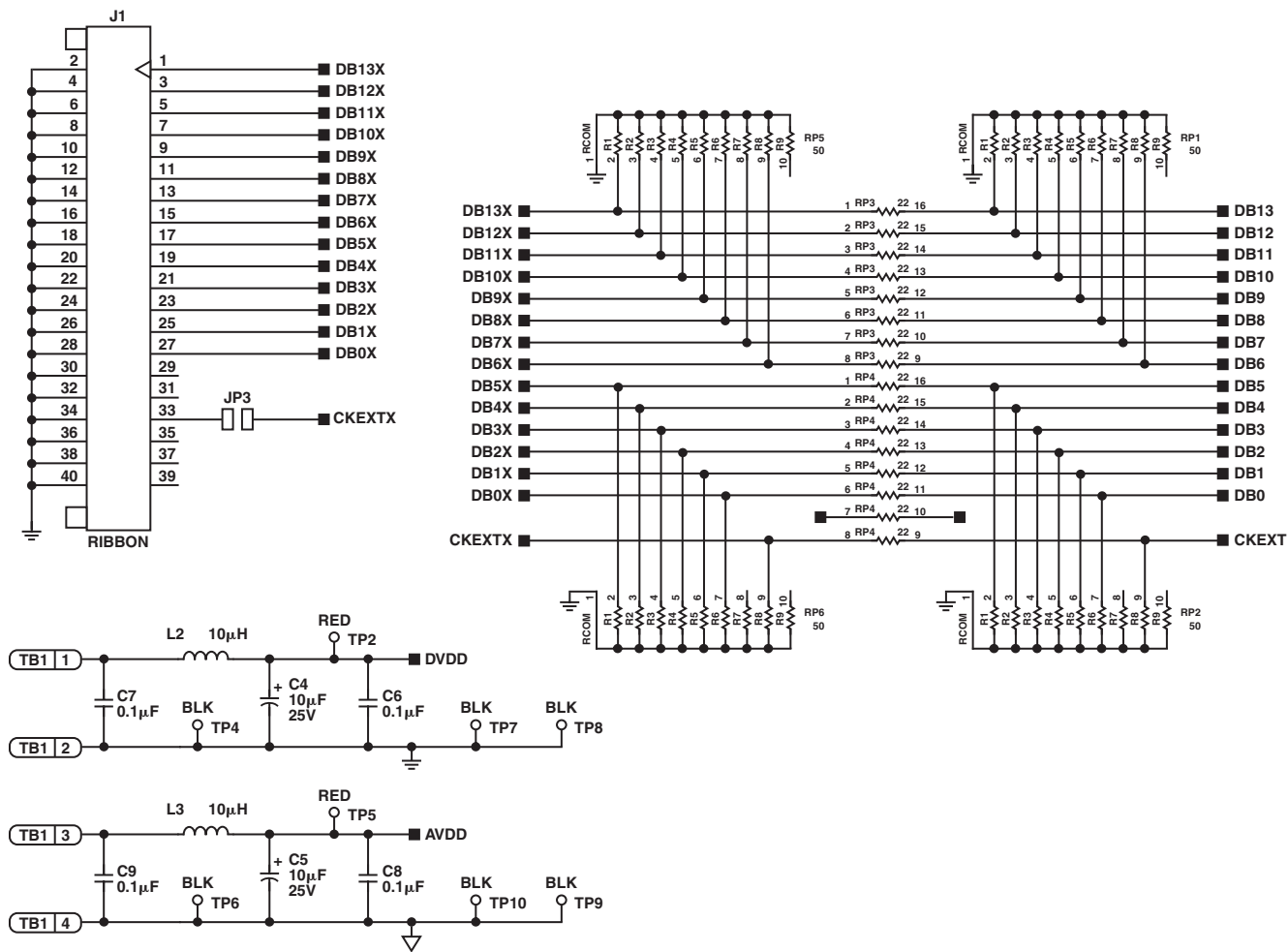

Figure 17. Evaluation Board: Power Supply and Digital Inputs

AD9740

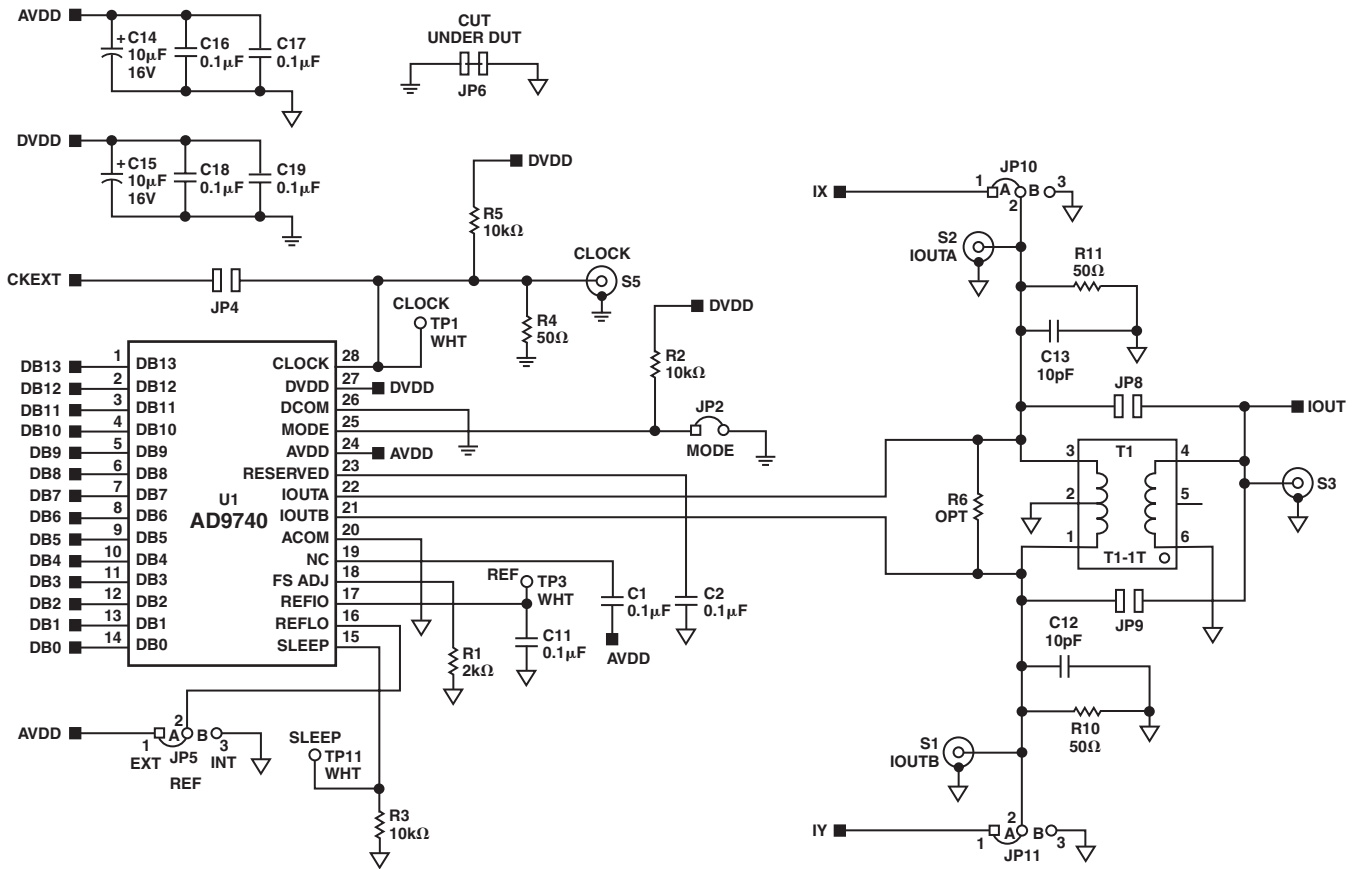

Figure 18. Evaluation Board: Output Signal Conditioning

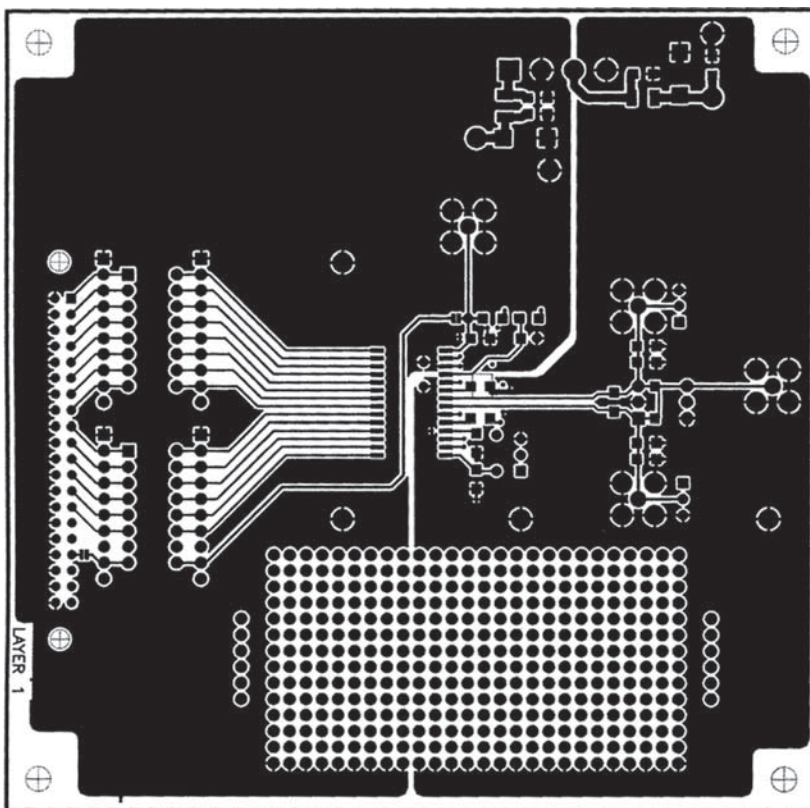

Figure 19. Primary Side

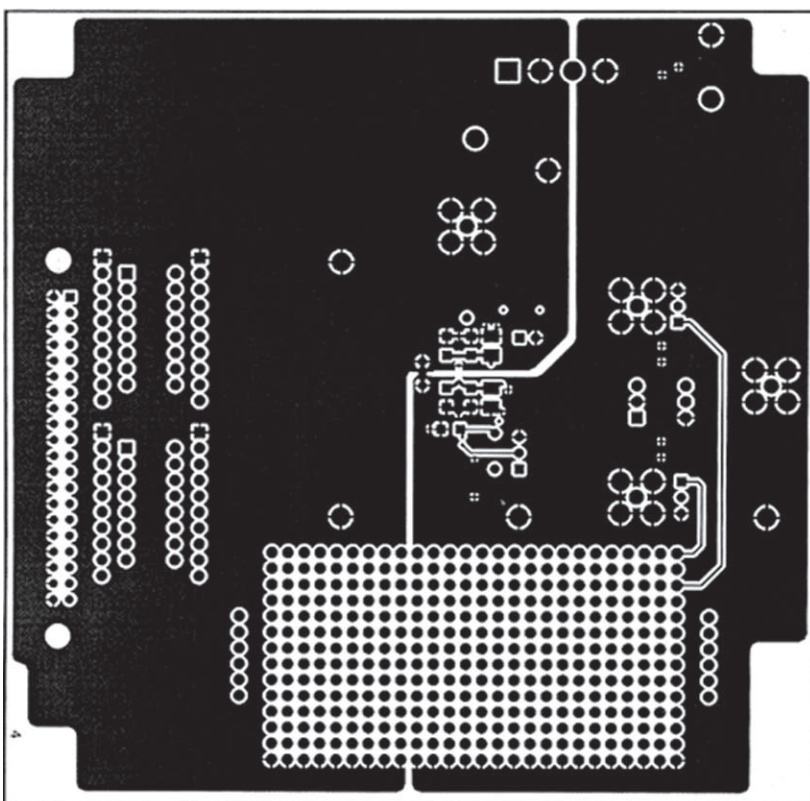

Figure 20. Secondary Side

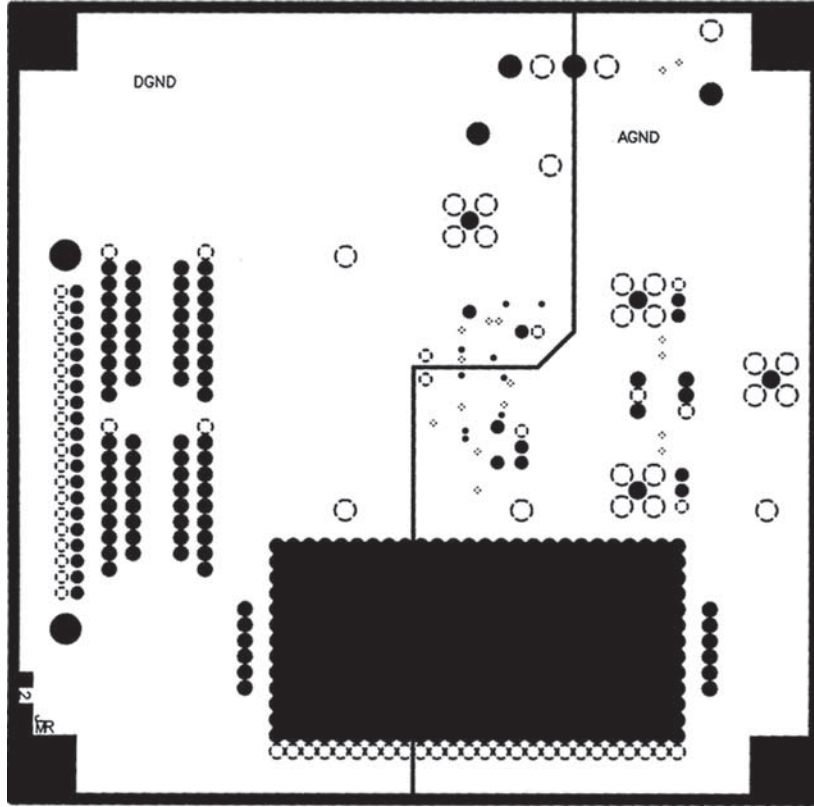

Figure 21. Ground Plane

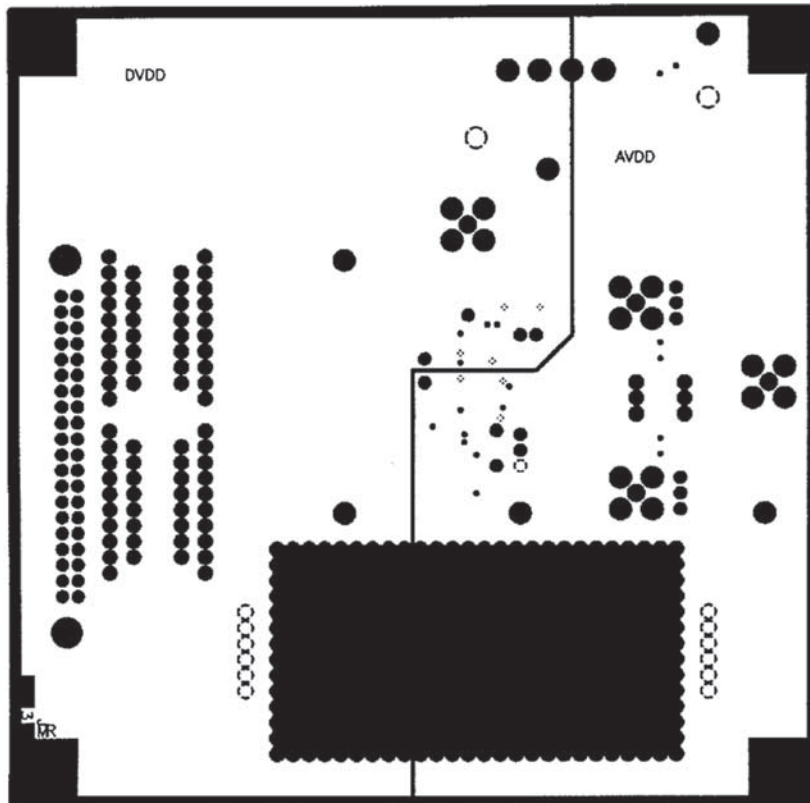

Figure 22. Power Plane

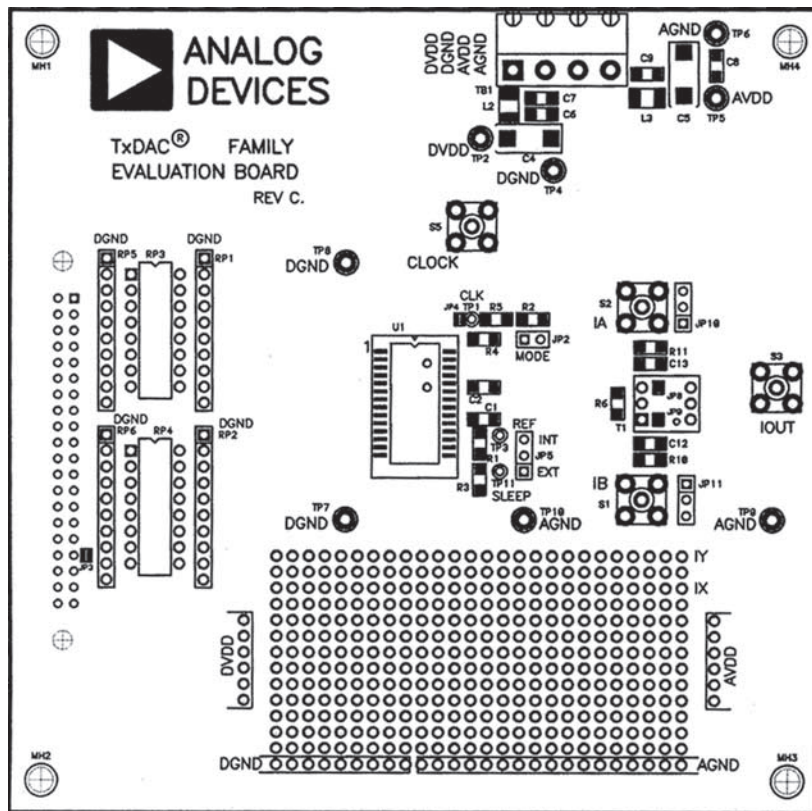

Figure 23. Assembly – Primary Side

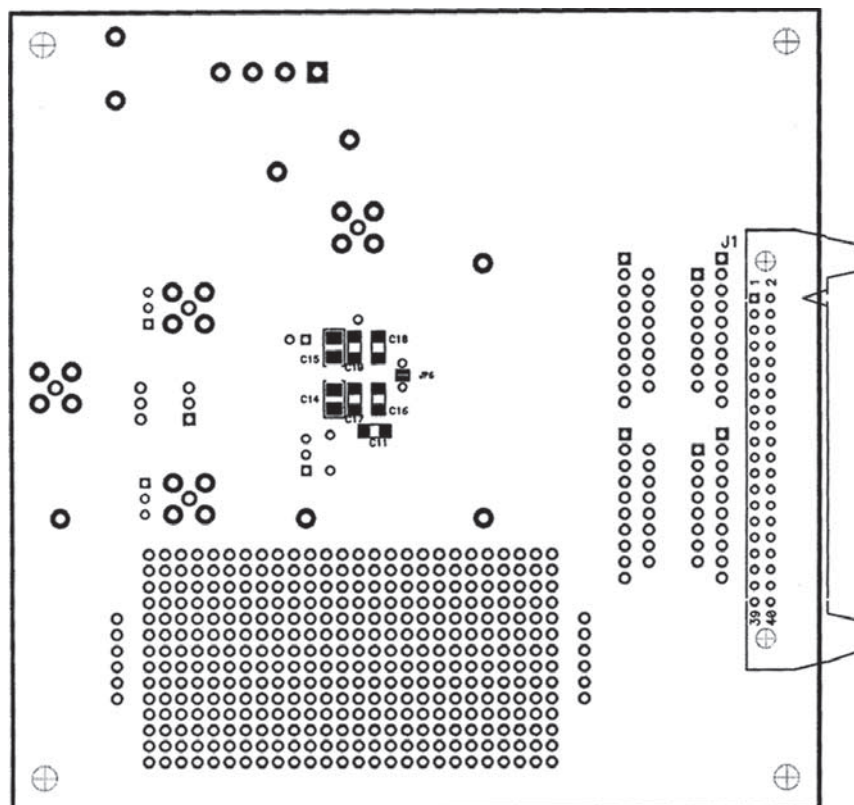
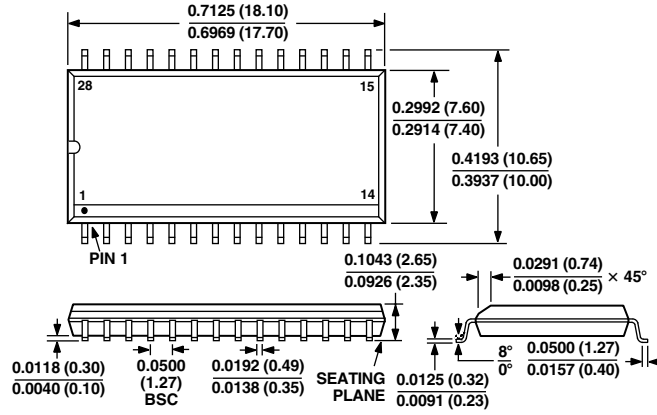

Figure 24. Assembly – Secondary Side

OUTLINE DIMENSIONS

Dimensions shown in inches and (mm)

28-Lead Standard Small Outline Package (SOIC)
(R-28)



28-Lead Thin Shrink SO Package (TSSOP)
(RU-28)

