

**SILICON TRANSISTOR**  
**2SC4173**

**HIGH FREQUENCY AMPLIFIER AND SWITCHING**  
**NPN SILICON EPITAXIAL TRANSISTOR**

**PACKAGE DIMENSIONS**

in millimeters

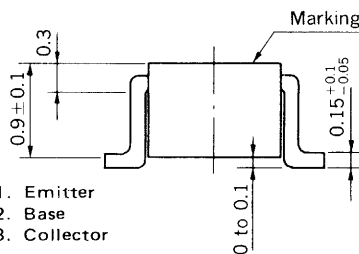
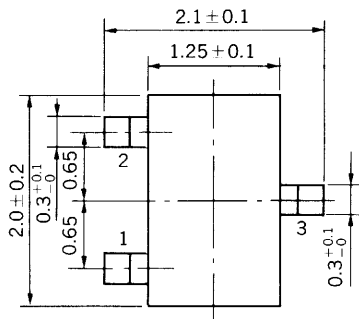

- 1. Emitter
- 2. Base
- 3. Collector

**FEATURES**

- High Gain Bandwidth Product:  $f_T = 200$  MHz MIN.
- Complementary to 2SA1608

**ABSOLUTE MAXIMUM RATINGS**

Maximum Voltages and Current ( $T_a = 25^\circ\text{C}$ )

Collector to Base Voltage	$V_{CB0}$	60	V
Collector to Emitter Voltage	$V_{CEO}$	40	V
Emitter to Base Voltage	$V_{EBO}$	5.0	V
Collector Current (DC)	$I_C$	500	mA

Maximum Power Dissipation

Total Power Dissipation			
at $25^\circ\text{C}$ Ambient Temperature	$P_T$	150	mW

Maximum Temperatures

Junction Temperature	$T_j$	150	$^\circ\text{C}$
Storage Temperature Range	$T_{stg}$	-55 to +150	$^\circ\text{C}$

**ELECTRICAL CHARACTERISTICS ( $T_a = 25^\circ\text{C}$ )**

CHARACTERISTIC	SYMBOL	MIN.	TYP.	MAX.	UNIT	TEST CONDITIONS
Collector Cutoff Current	$I_{CB0}$			100	nA	$V_{CB} = 40\text{ V}, I_E = 0$
Emitter Cutoff Current	$I_{EBO}$			100	nA	$V_{EB} = 4.0\text{ V}, I_C = 0$
DC Current Gain	$h_{FE1}$	75	150	300		$V_{CE} = 1.0\text{ V}, I_C = 150\text{ mA}$
DC Current Gain	$h_{FE2}$	20	75			$V_{CE} = 2.0\text{ V}, I_C = 500\text{ mA}$
Collector Saturation Voltage	$V_{CE(sat)}$		0.25	0.75	V	$I_C = 500\text{ mA}, I_B = 50\text{ mA}$
Base Saturation Voltage	$V_{BE(sat)}$		1.0	1.2	V	$I_C = 500\text{ mA}, I_B = 50\text{ mA}$
Gain Bandwidth Product	$f_T$	200	400		MHz	$V_{CE} = 10\text{ V}, I_E = -20\text{ mA}$
Output Capacitance	$C_{ob}$		3.5	8.0	pF	$V_{CB} = 10\text{ V}, I_E = 0, f = 1.0\text{ MHz}$
Turn-on Time	$t_{on}$		30		ns	$V_{CC} = 30\text{ V}$
Storage Time	$t_{stg}$		150		ns	$I_C = 150\text{ mA}$
Turn-off Time	$t_{off}$		180		ns	$I_{B1} = -I_{B2} = 15\text{ mA}$

\* Pulsed:  $PW \leq 350\ \mu\text{s}$ , Duty Cycle  $\leq 2\%$

**$h_{FE}$  Classification**

Marking	B12	B13	B14
$h_{FE1}$	75 to 150	100 to 200	150 to 300

SWITCHING TIME TEST CIRCUIT

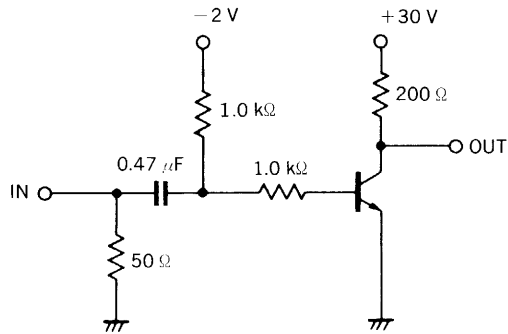

$t_{on}$  SWITCHING

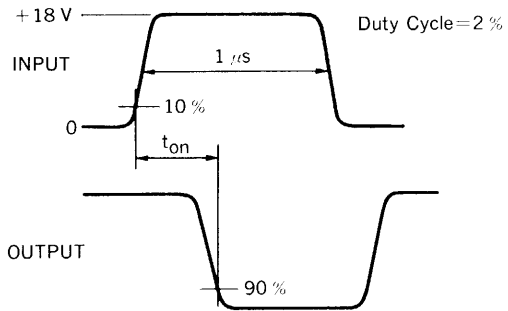

VOLTAGE WAVEFORMS

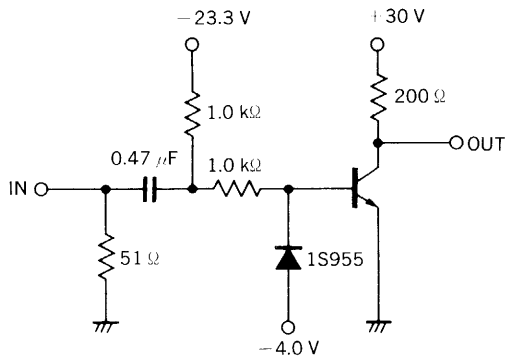

$t_{off}$  SWITCHING

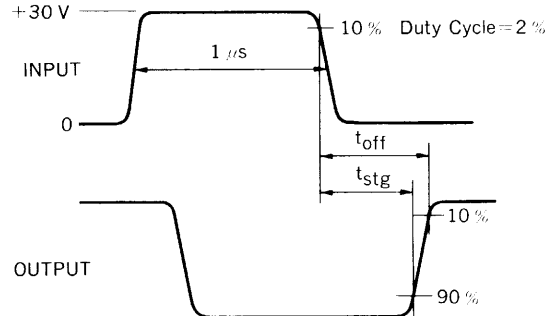

VOLTAGE WAVEFORMS

TYPICAL CHARACTERISTICS ( $T_a = 25^\circ\text{C}$ )

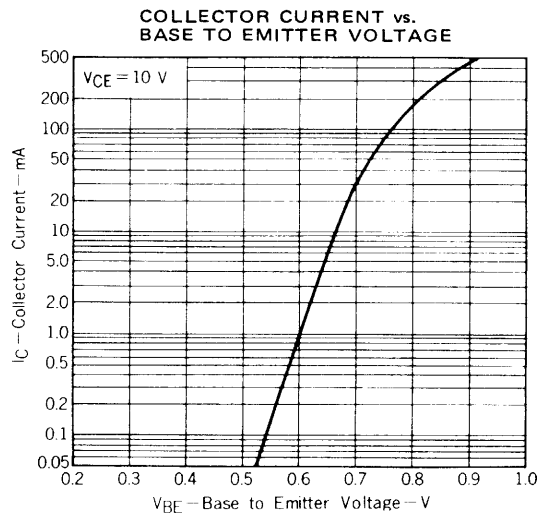
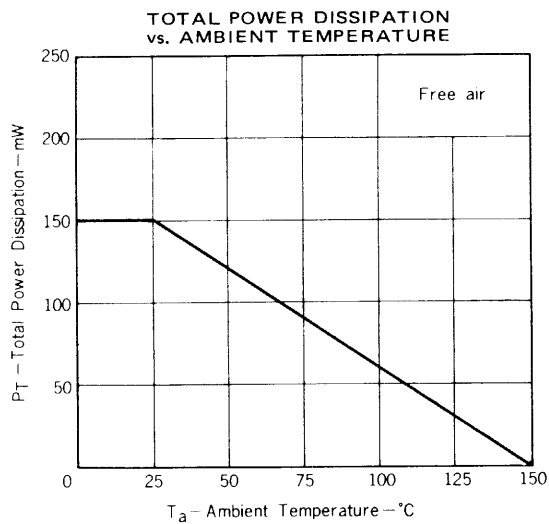

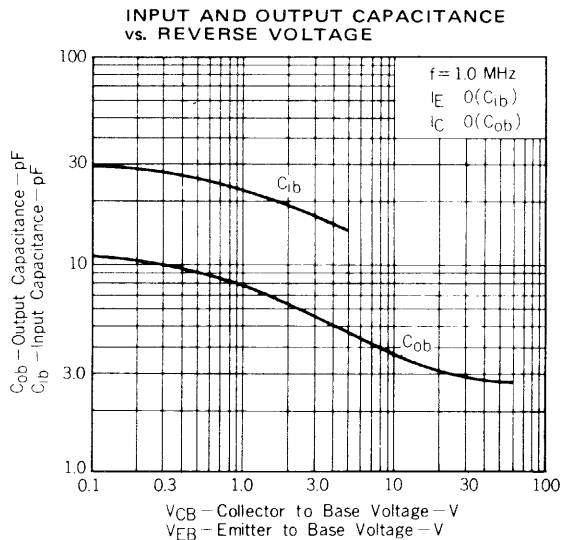
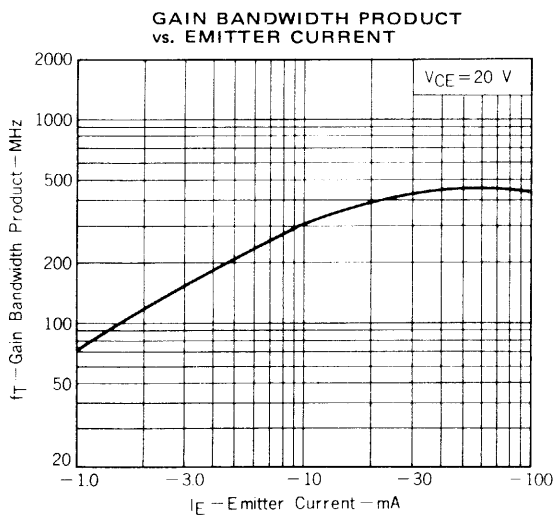
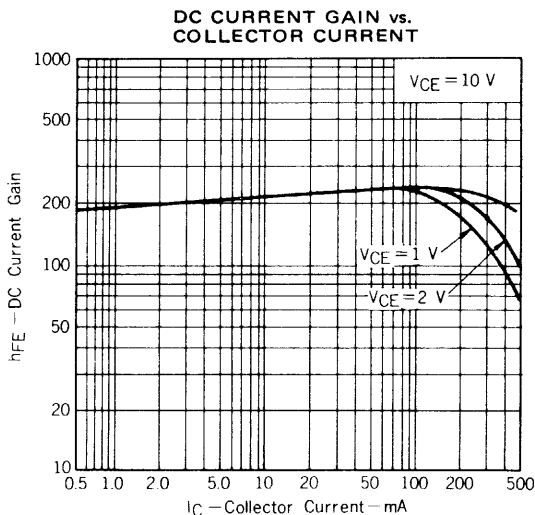
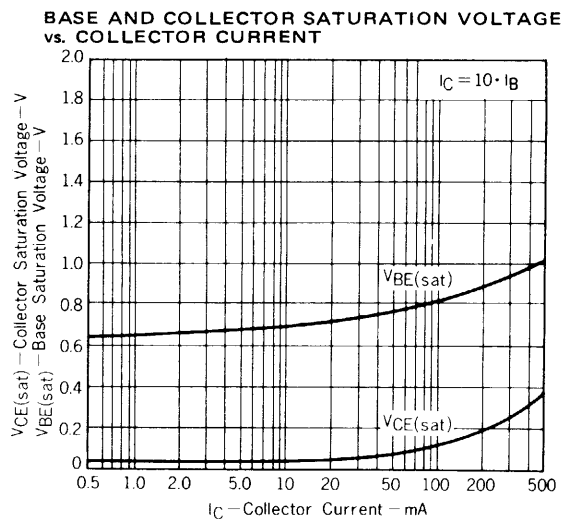
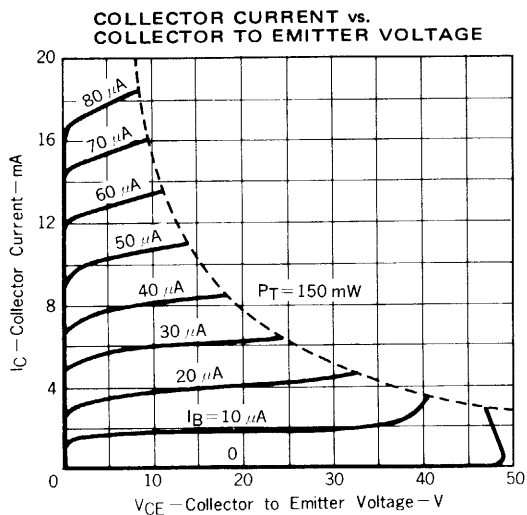

DELAY TIME vs. COLLECTOR CURRENT

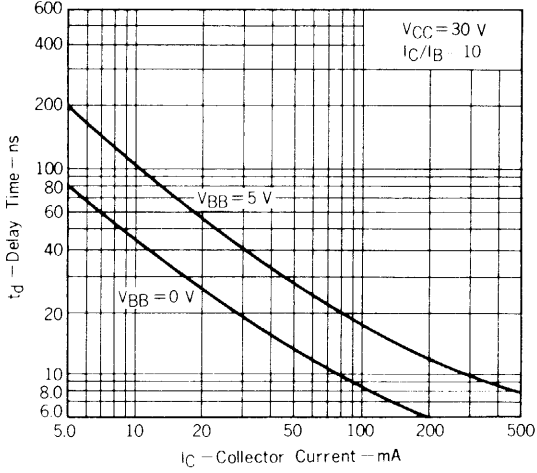

RISE TIME vs. COLLECTOR CURRENT

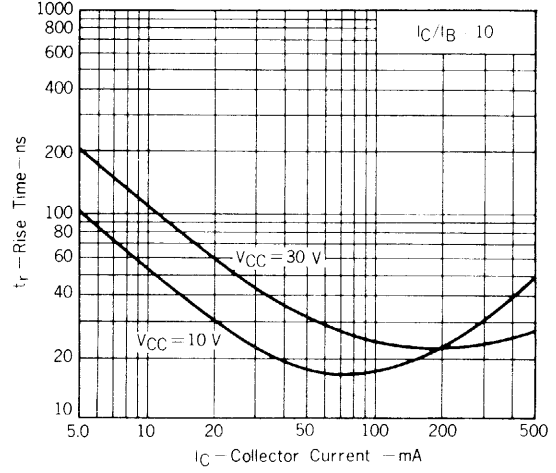

STORAGE TIME vs. COLLECTOR CURRENT

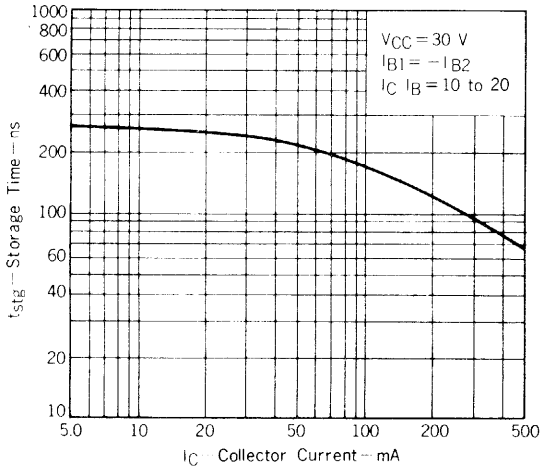

FALL TIME vs. COLLECTOR CURRENT

