

NPN Medium Power Transistor (Switching)

UMT4401 / SST4401 / MMST4401 / 2N4401

●Features

- 1) $BV_{CEO} > 40V$ ($I_C = 1mA$)
- 2) Complements the UMT4403 / SST4403 / MMST4403 / PN4403.

●Package, marking, and packaging specifications

Part No.	UMT4401	SST4401	MMST4401	2N4401
Packaging type	UMT3	SST3	SMT3	TO-92
Marking	R2X	R2X	R2X	-
Code	T106	T116	T146	T93
Basic ordering unit (pieces)	3000	3000	3000	3000

●Absolute maximum ratings ($T_a = 25^\circ C$)

Parameter	Symbol	Limits	Unit	
Collector-base voltage	V_{CB0}	60	V	
Collector-emitter voltage	V_{CE0}	40	V	
Emitter-base voltage	V_{EB0}	6	V	
Collector current	I_C	0.6	A	
Collector power dissipation	UMT4401 SST4401 MMST4401	P_C	0.2	W
	2N4401		0.625	
Junction temperature	T_J	150	$^\circ C$	
Storage temperature	T_{stg}	-55~+150	$^\circ C$	

●External dimensions (Units : mm)

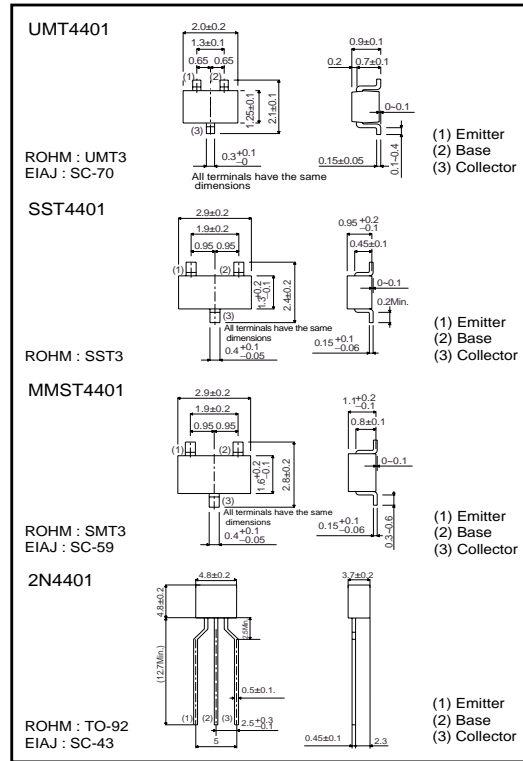

●Electrical characteristics ($T_a = 25^\circ C$)

Parameter	Symbol	Min.	Typ.	Max.	Unit	Conditions
Collector-base breakdown voltage	BV_{CB0}	60	-	-	V	$I_C = 100\mu A$
Collector-emitter breakdown voltage	BV_{CE0}	40	-	-	V	$I_C = 1mA$
Emitter-base breakdown voltage	BV_{EB0}	6	-	-	V	$I_E = 100\mu A$
Collector cutoff current	I_{CBO}	-	-	0.1	μA	$V_{CE} = 35V$
Emitter cutoff current	I_{EBO}	-	-	0.1	μA	$V_{EB} = 5V$
Collector-emitter saturation voltage	$V_{CE(sat)}$	-	-	0.4	V	$I_C/I_B = 150mA/15mA$
		-	-	0.75	V	$I_C/I_B = 500mA/50mA$
Base-emitter saturation voltage	$V_{BE(sat)}$	-	-	0.95	V	$I_C/I_B = 150mA/15mA$
		-	-	1.2	V	$I_C/I_B = 500mA/50mA$
DC current transfer ratio	h_{FE}	20	-	-	-	$V_{CE} = 1V, I_C = 0.1mA$
		40	-	-	-	$V_{CE} = 1V, I_C = 1mA$
		80	-	-	-	$V_{CE} = 1V, I_C = 10mA$
		100	-	300	-	$V_{CE} = 1V, I_C = 150mA$
		40	-	-	-	$V_{CE} = 2V, I_C = 500mA$
Transition frequency	f_T	250	-	-	MHz	$V_{CE} = 10V, I_E = 20mA, f = 100MHz$
Collector output capacitance	C_{ob}	-	-	6.5	pF	$V_{CB} = 10V, f = 100kHz$
Emitter input capacitance	C_{ib}	-	-	30	pF	$V_{EB} = 0.5V, f = 100kHz$
Delay time	t_d	-	-	15	ns	$V_{CC} = 30V, V_{BE(OFF)} = 2V, I_C = 150mA, I_{B1} = 15mA$
Rise time	t_r	-	-	20	ns	$V_{CC} = 30V, V_{BE(OFF)} = 2V, I_C = 150mA, I_{B1} = 15mA$
Storage time	t_{stg}	-	-	225	ns	$V_{CC} = 30V, I_C = 150mA, I_{B1} = I_{B2} = 15mA$
Fall time	t_f	-	-	30	ns	$V_{CC} = 30V, I_C = 150mA, I_{B1} = I_{B2} = 15mA$

Transistors

●Electrical characteristic curves

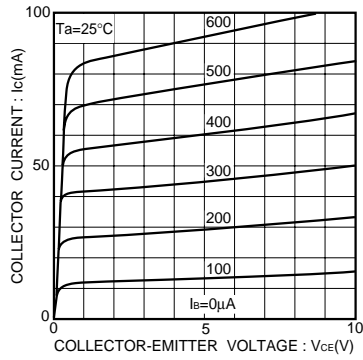

Fig.1 Grounded emitter output characteristics

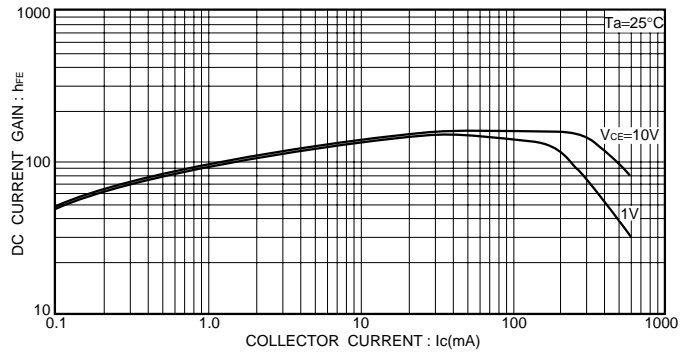

Fig.3 DC current gain vs. collector current(I)

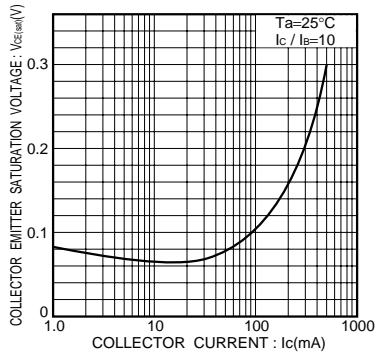

Fig.2 Collector-emitter saturation voltage vs. collector current

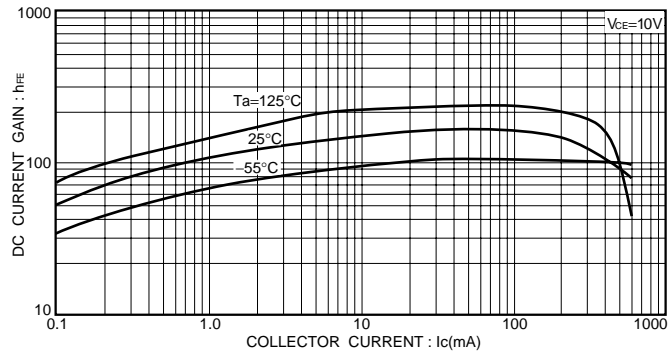

Fig.4 DC current gain vs. collector current(II)

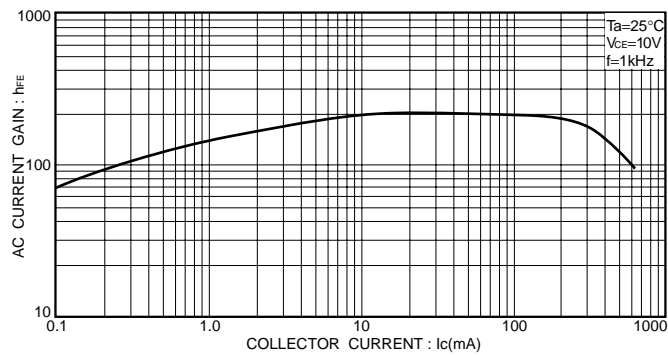

Fig.5 AC current gain vs. collector current

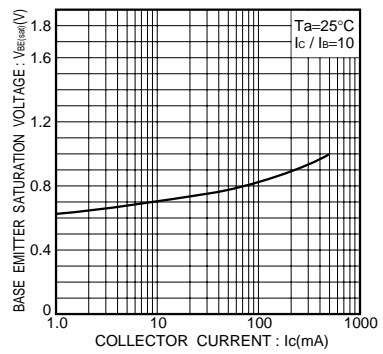

Fig.6 Base-emitter saturation voltage vs. collector current

Transistors

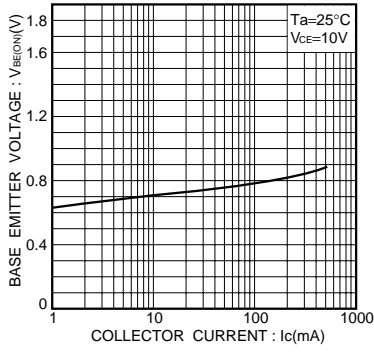

Fig.7 Grounded emitter propagation characteristics

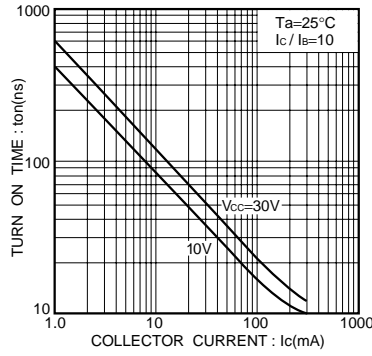

Fig.8 Turn-on time vs. collector current

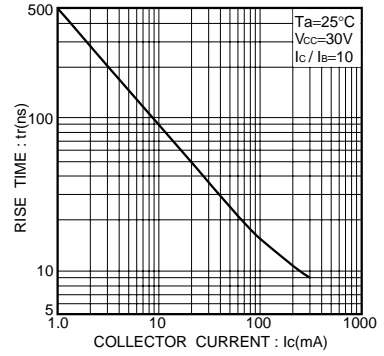

Fig.9 Rise time vs. collector current

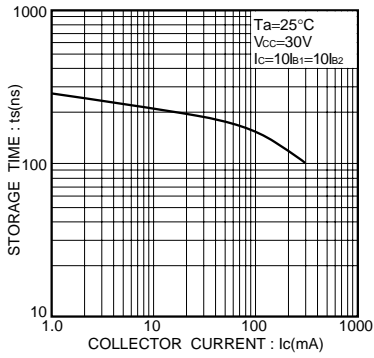

Fig.10 Storage time vs. collector current

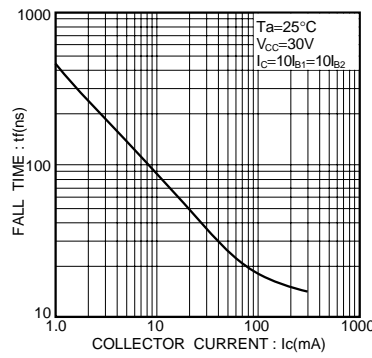

Fig.11 Fall time vs. collector current

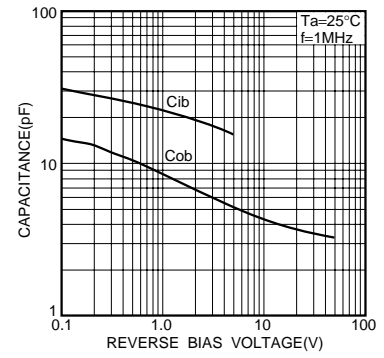

Fig.12 Input/output capacitance vs. voltage

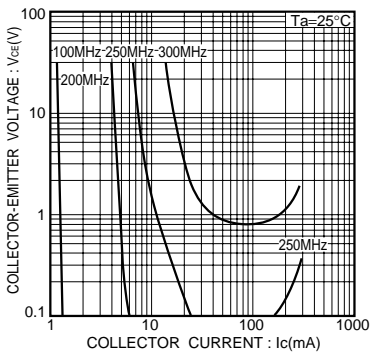

Fig.13 Gain bandwidth product

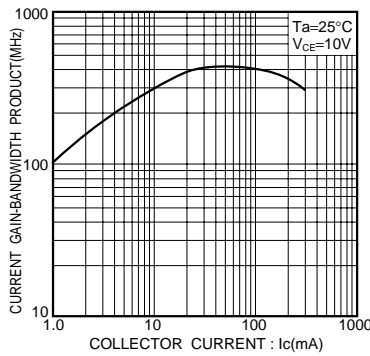

Fig.14 Gain bandwidth product vs. collector current