

SIEMENS

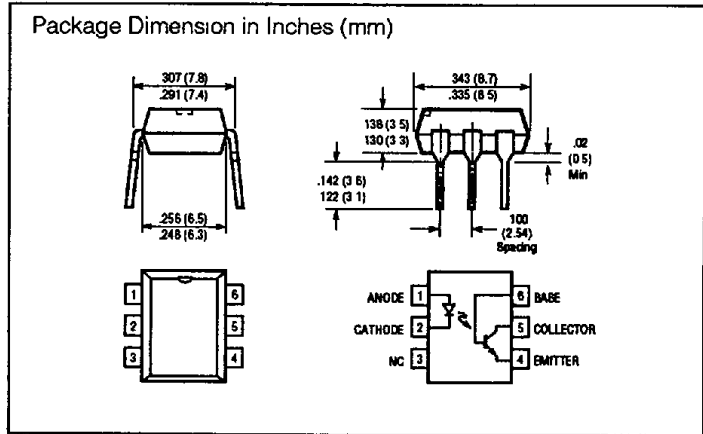

SFH601 SERIES

**PHOTOTRANSISTOR
OPTOCOUPLER**

T-41-83



FEATURES

- Highest Quality Premium Device
- Built to Conform to VDE Requirements
- Long Term Stability
- High Current Transfer Ratios, 4 Groups
 SFH 601-1, 40 to 80%
 SFH 601-2, 63 to 125%
 SFH 601-3, 100 to 200%
 SFH 601-4, 160 to 320%
- 5300 Volt Isolation (1 Minute)
- Storage Temperature -40° to +150°C
- V_{CEsat} 0.25 (<0.4) Volt at $I_F = 10$ mA, $I_C = 2.5$ mA
- UL Approval #E52744
-  VDE Approval #0883
-  VDE Approval #0884 (Optional with Option 1, add -X001 suffix)
- CECC Approved

DESCRIPTION

The SFH601 is an optocoupler that is comprised of a GaAs LED emitter which is optically coupled with a silicon planar phototransistor detector. The component is packaged in a plastic plug-in case 20 AB DIN 41866. The coupler transmits signals between two electrically isolated circuits. The potential difference between the circuits to be coupled is not allowed to exceed the maximum permissible insulating voltage.

Maximum Ratings

Reverse Voltage (V_R)	6 V
Forward Current (I_F)	60 mA
Surge Current (I_{FS}), $t_p = 10 \mu s$	2.5 A
Power Dissipation (P_{Tot})	100 mW
Detector (Silicon Phototransistor)	
Collector-Emitter Voltage (V_{CE0})	70 V
Emitter Base Reverse Voltage (V_{EBO})	7 V
Collector Current (I_C)	50 mA
Collector Current (I_{CS}), $t = 1$ ms	100 mA
Power Dissipation (P_{Tot})	150 mW
Coupler	
Storage Temperature (T_{stor})	-40 to +150°C
Ambient Temperature (T_{amb})	-40 to +100°C
Junction Temperature (T_j)	100°C
Soldering Temperature (T_L), 10 s Max	260°C
Isolation Test Voltage (V_{IS}), 1 Min per VDE 0883 (between emitter and detector referred to standard climate 23/50 DIN 50014)	5300 VDC
Tracking Resistance	Min 8.2 mm
Air Path	Min 7.3 mm
Tracking Resistance	
Group III (KC = >600) in accordance with VDE 0110 j 6 Table 3 and DIN 53480/VDE 0303, Part 1	
As to nominal isolation voltage DIN 57883 or VDE 0883 applies	
Isolation Resistance (R_{I0}) at $V_{IS} = 500$ V	$10^{11} \Omega$
Climatic Conditions	
DIN 40040, humidity Class F	
Flammability	
DIN 57471 or VDE 0471, Part 2, of April 1975 or MIL202E, Method 11 A	

Characteristics (T_{amb} = 25 °C)

Emitter (GaAs LED)

Forward Voltage (V _F), I _F = 60 mA	1.25 (≤ 1.65) V
Breakdown Voltage (V _{BR}), I _R = 100 μA	30 (≥ 6) V
Reverse Current (I _R), V _R = 3 V	0.01 (≤ 10) μA
Capacitance (C ₀) (V _R = 0 V, f = 1 MHz)	40 pF
Thermal Resistance (R _{thJamb})	750 K/W

Detector (Silicon Phototransistor)

Capacitance (V _{CE} = 5 V, f = 1 MHz)	6.8 pF
C _{CE}	8.5 pF
C _{CB}	11 pF
C _{EB}	500 K/W
Thermal Resistance (R _{thJamb})	

Coupler

Collector-Emitter Saturation Voltage (V _{CEsat}) (I _F = 10 mA, I _C = 2.5 mA)	0.25 (< 0.4) V
Coupling Capacitance (C _K)	0.30 pF

The optocouplers are grouped according to their current transfer ratio I_C/I_F at V_{CE} = 5 V, marked by dash numbers

	-1	-2	-3	-4	
I _C /I _F (I _F = 10 mA)	40-80	63-125	100-200	160-320	%
I _C /I _F (I _F = 1 mA)	30 (>13)	45 (>22)	70 (>34)	90 (>56)	%
Collector-Emitter Leakage Current (V _{CE} = 10 V) (I _{CEO})	2 (≤50)	2 (≤50)	5 (≤100)	5 (≤100)	nA

Linear Operation (without saturation)

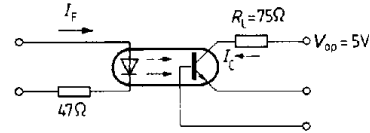

I_F = 10 mA, V_{Op} = 5 V, T_{amb} = 25 °C

Load Resistance	R _L	75	Ω
Turn-On Time	t _{ON}	3.0 (≤5.6)	μs
Rise Time	t _r	2.0 (≤4.0)	μs
Turn-Off Time	t _{OFF}	2.3 (≤4.1)	μs
Fall Time	t _f	2.0 (≤3.5)	μs
Cut-Off Frequency	F _{CO}	250	KHz

Switching Operation (with saturation)

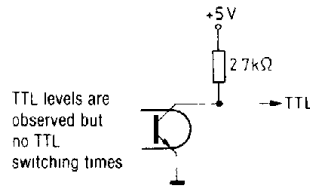
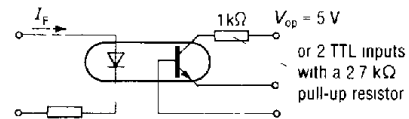

Group	-1 (I _F = 20 mA)	-2 and -3 (I _F = 10 mA)	-4 (I _F = 5 mA)	
Turn-On Time t _{ON}	3.0 (≤5.5)	4.2 (≤8.0)	6.0 (≤10.5)	μs
Rise Time t _r	2.0 (≤4.0)	3.0 (≤6.0)	4.6 (≤8.0)	μs
Turn-Off Time t _{OFF}	18 (≤34)	23 (≤39)	25 (≤43)	μs
Fall Time t _f	11 (≤20)	14 (≤24)	15 (≤26)	μs
V _{CEsat}	0.25 (≤0.4)			V

Optocouplers (Optoisolators)

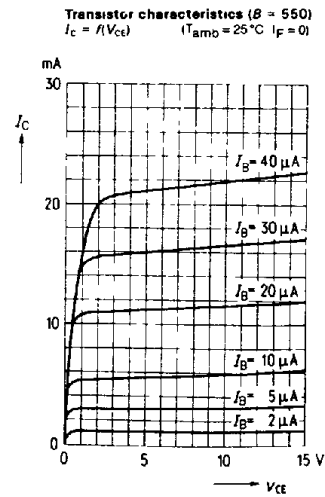
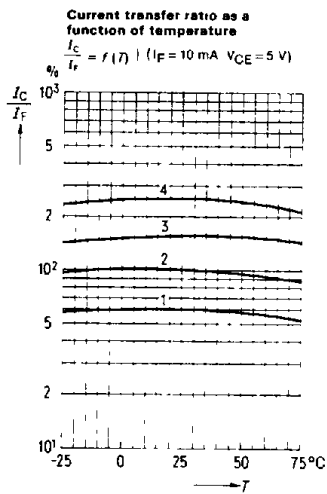
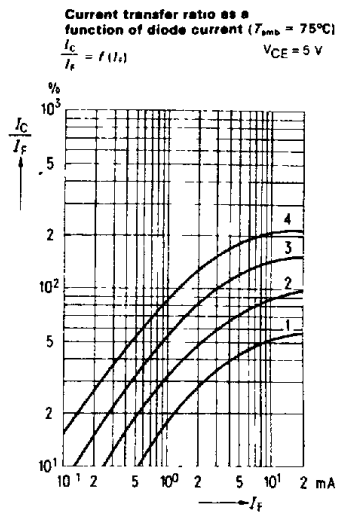
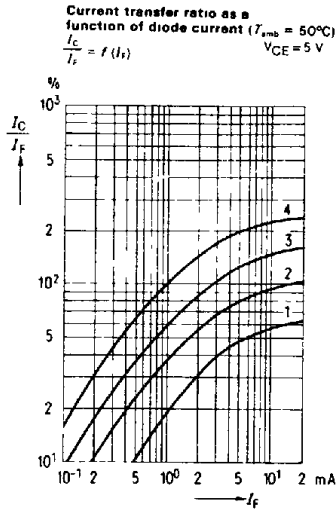
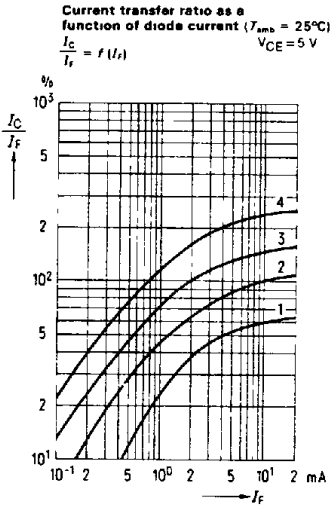
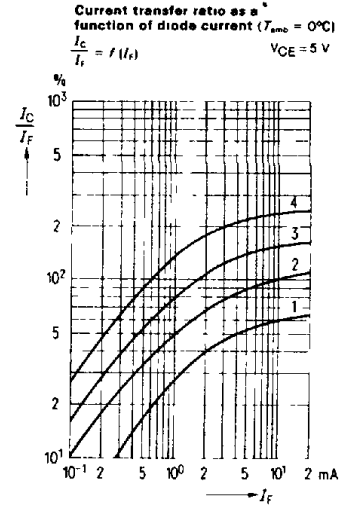
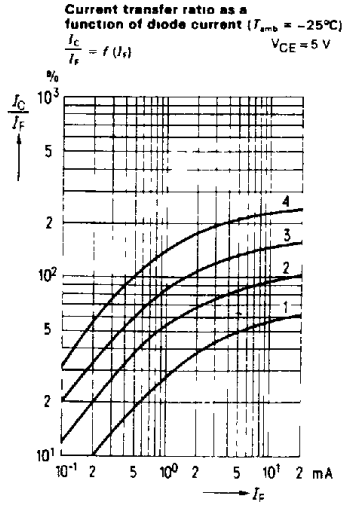
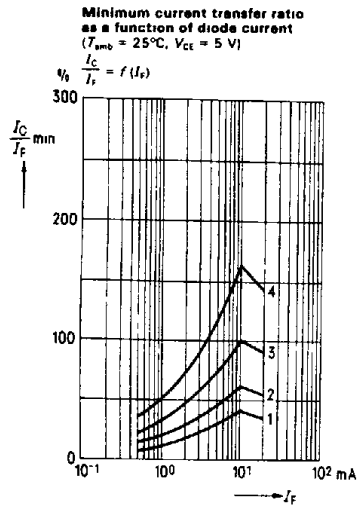

Output characteristics $I_C = f(V_{CE})$
($T_{amb} = 25^\circ\text{C}$)

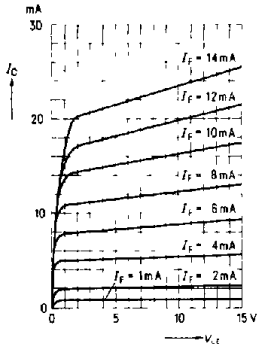

Forward voltage $V_F = f(I_F)$

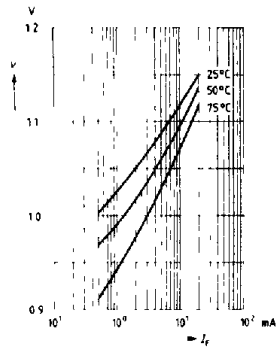

Collector-emitter off-state current
 $I_{CED} = f(V, T)$ ($T_{amb} = 25^\circ\text{C}$, $I_F = 0$)

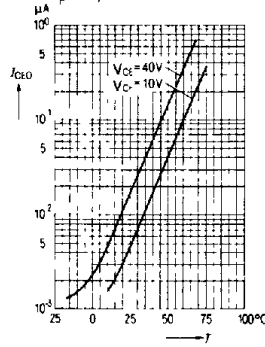

Saturation voltage as a function of collector current and modulation depth for SFH 601-1
 $V_{CE sat} = f(I_C)$ ($T_{amb} = 25^\circ\text{C}$)

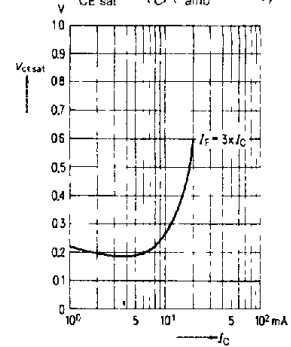

Saturation voltage as a function of collector current and modulation depth for SFH 601-2
 $V_{CE sat} = f(I_C)$ ($T_{amb} = 25^\circ\text{C}$)

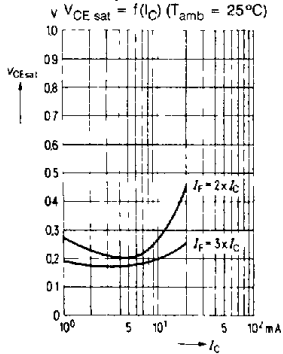

Saturation voltage as a function of collector current and modulation depth for SFH 601-3
 $V_{CE sat} = f(I_C)$ ($T_{amb} = 25^\circ\text{C}$)

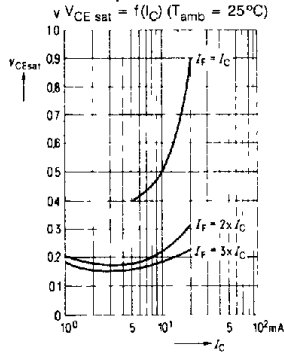

Saturation voltage as a function of collector current and modulation depth for SFH 601-4
 $V_{CE sat} = f(I_C)$ ($T_{amb} = 25^\circ\text{C}$)

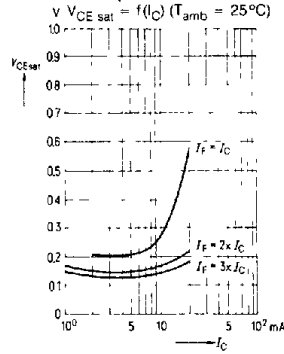

Diode capacitance $C = f(V_R)$
($T_{amb} = 25^\circ\text{C}$, $f = 1 \text{ MHz}$)

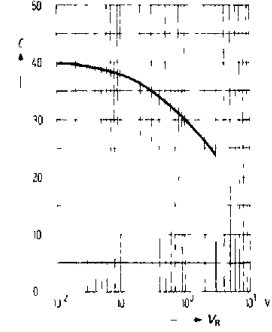

Permissible pulse load
 $V = \text{parameter}$ ($T_{amb} = 25^\circ\text{C}$, $I_F = f(t)$)

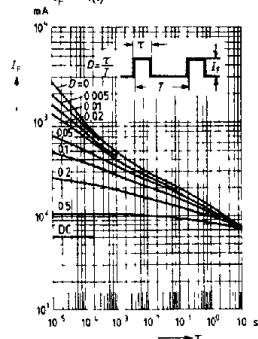

Permissible loss transistor
 $P_{tot} = f(T_{amb})$

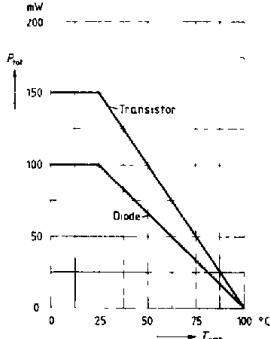

Permissible loss diode
 $P_{tot} = f(T_{amb})$

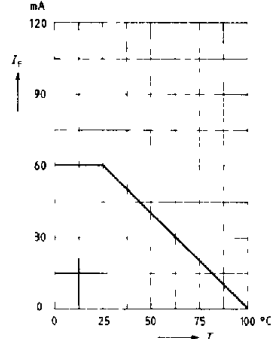

Transistor capacitances
 $C = f(V_{CE})$ ($T_{amb} = 25^\circ\text{C}$, $f = 1 \text{ MHz}$)

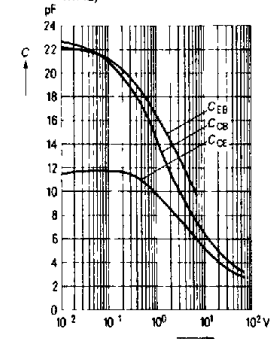

Variation of current transfer ratio as a function of load time

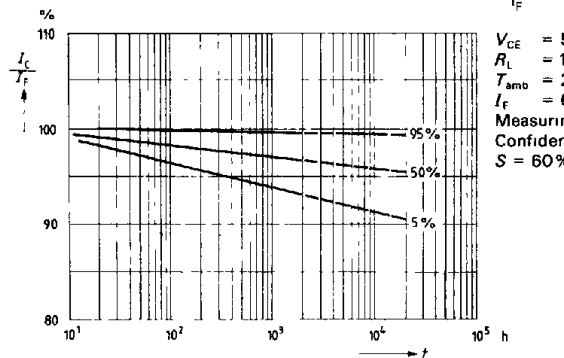

Optocouplers (Optoisolators)