

MCM62963A

Product Preview
4K x 10 Bit Synchronous Static RAM
with Output Registers



The MCM62963A is a 40,960 bit synchronous static random access memory organized as 4096 words of 10 bits, fabricated using Motorola's second-generation high-performance silicon-gate CMOS (HCMOS III) technology. The device integrates input registers, high speed SRAM, and high-drive capability output registers onto a single monolithic circuit. This allows reduced parts count implementation of cache data RAM, writable control store applications, and other applications that utilize long words.

Synchronous design allows precise cycle control with the use of an external clock (K), while CMOS circuitry reduces the overall power consumption of the integrated functions for greater reliability.

The address (A0-A11), data (D0-D9), write (\bar{W}), and chip enable (\bar{E}) inputs are all clock (K) controlled, positive-edge-triggered, noninverting registers.

The chip enable (\bar{E}) input is a synchronous input clock that places the device in a low power mode when high at the rising edge of the clock (K).

The MCM62963A provides output register operation. At the rising edge of clock (K), the RAM data from the previous clock (K) high cycle is presented.

Write operations are internally self-timed and initiated by the rising edge of the clock (K) input. This feature eliminates complex off-chip write pulse generation and provides increased flexibility for incoming signals.

- Single 5 V \pm 10% Power Supply
- Fast Cycle Times: 30 ns Max
- Fast Clock (K) Access Times: 13 ns Max
- Address, Data Input, \bar{E} , and \bar{W} Registers On-Chip
- Output Registers for Fully Pipelined Applications
- High Output Drive Capability
- Internally Self-Timed Write Pulse Generation
- Separate Data Input and Data Output Pins

PIN ASSIGNMENT

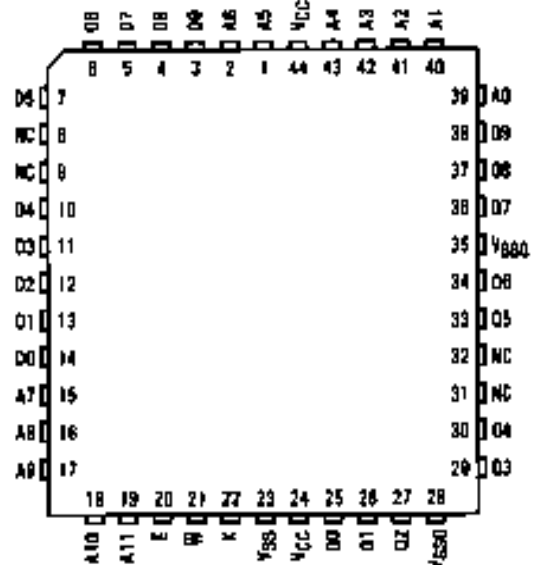

BLOCK DIAGRAM

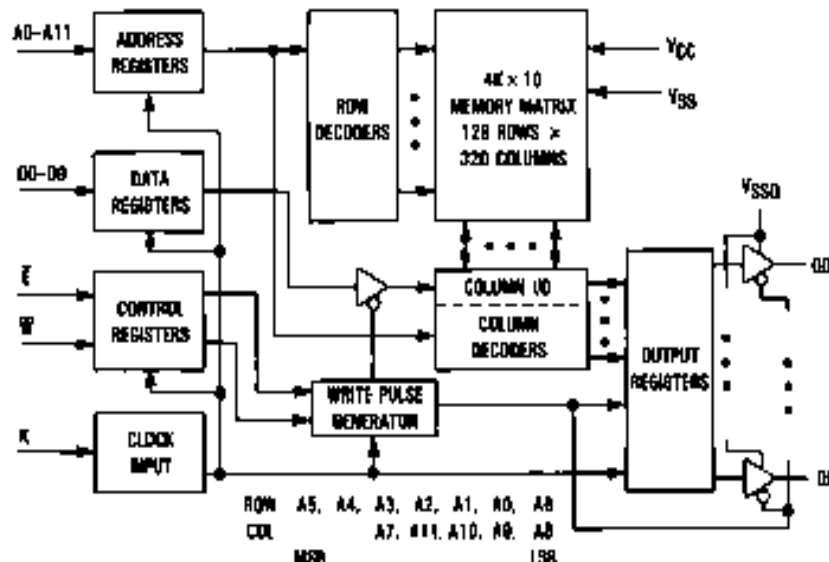

PIN NAMES	
A0-A11	Address Inputs
\bar{W}	Write Enable
\bar{E}	Chip Enable
D0-D9	Data Inputs
D0-D9	Data Outputs
K	Clock Input
VCC	+5 V Power Supply
VSS	Ground
VSSD	Output Buffer Ground
NC	No Connection

For proper operation of the device VSS and both VSSD leads must be connected to ground.

TRUTH TABLE

\bar{E}	\bar{W}	Operation	Q0-Q9	Current
L	L	Write	High Z	I_{CC}
L	H	Read	D_{out}	I_{CC}
H	X	Not Selected	High Z	I_{SB}

NOTE: The values of \bar{E} and \bar{W} are valid inputs for the setup and hold times relative to the K rising edge.

ABSOLUTE MAXIMUM RATINGS (Voltages referenced to $V_{SS}=V_{SSQ}=0$ V)

Rating	Symbol	Value	Unit
Power Supply Voltage	V_{CC}	-0.5 to +7.0	V
Voltage Relative to V_{SS}/V_{SSQ} for Any Pin Except V_{CC}	V_{in}, V_{out}	-0.5 to $V_{CC}+0.5$	V
Output Current (per I/O)	I_{out}	± 20	mA
Power Dissipation ($T_A=25^\circ\text{C}$)	P_D	1.0	W
Temperature Under Bias	T_{bias}	-10 to +85	$^\circ\text{C}$
Operating Temperature	T_A	0 to +70	$^\circ\text{C}$
Storage Temperature	T_{stg}	-55 to +125	$^\circ\text{C}$

NOTE: Permanent device damage may occur if ABSOLUTE MAXIMUM RATINGS are exceeded. Functional operation should be restricted to RECOMMENDED OPERATING CONDITIONS. Exposure to higher than recommended voltages for extended periods of time could affect device reliability.

This device contains circuitry to protect the inputs against damage due to high static voltages or electric fields; however, it is advised that normal precautions be taken to avoid application of any voltage higher than maximum rated voltages to this high-impedance circuit.

This is a synchronous device. All synchronous inputs must meet the specified setup and hold times with stable logic levels for ALL rising edges of clock (K) while the device is selected.

This device contains circuitry that will ensure the output devices are in High Z at power up. Care should be taken by the user to ensure that all clocks are at V_{IL} or V_{IH} during power up to prevent spurious read cycles from occurring.

DC OPERATING CONDITIONS AND CHARACTERISTICS

($V_{CC}=5.0$ V $\pm 10\%$, $T_A=0$ to 70°C , Unless Otherwise Noted)

RECOMMENDED OPERATING CONDITIONS (Voltages referenced to $V_{SS}=V_{SSQ}=0$ V)

Parameter	Symbol	Min	Typ	Max	Unit
Supply Voltage (Operating Voltage Range)	V_{CC}	4.5	5.0	5.5	V
Input High Voltage	V_{IH}	2.2	—	$V_{CC}+0.3$	V
Input Low Voltage	V_{IL}	-0.5*	—	0.8	V

* V_{IL} (min) = -3.0 V ac (pulse width ≤ 20 ns)

DC CHARACTERISTICS

Parameter	Symbol	Min	Max	Unit
Input Leakage Current (All Inputs, $V_{in}=0$ to V_{CC})	$I_{kg(I)}$	—	± 1.0	μA
Output Leakage Current ($\bar{E}=V_{IH}$, $V_{out}=0$ to V_{CC} , Outputs must be high-Z)	$I_{kg(O)}$	—	± 1.0	μA
AC Supply Current ($\bar{E}=V_{IL}$, All Inputs = V_{IL} or V_{IH} , $I_{out}=0$ mA, Cycle Time $\geq t_{KHKH}$ min)	I_{CCA}	—	140	mA
Standby Current ($\bar{E}=V_{IH}$, $V_{IH} \geq 3.0$ V, $V_{IL} \leq 0.4$ V, $I_{out}=0$ mA, Cycle Time $\geq t_{KHKH}$ min)	I_{SB}	—	30	mA
Output Low Voltage ($I_{OL} = 12.7$ mA)	V_{OL}	—	0.4	V
Output High Voltage ($I_{OH} = -1.8$ mA)	V_{OH}	2.8	—	V

CAPACITANCE (f = 1.0 MHz, dV = 3.0 V, $T_A=25^\circ\text{C}$, Periodically Sampled Rather Than 100% Tested)

Characteristic	Symbol	Typ	Max	Unit
Input Capacitance	C_{in}	3	4	pF
Output Capacitance	C_{out}	5	7	pF

AC OPERATING CONDITIONS AND CHARACTERISTICS

(V_{CC}=5.0 V ± 10%, T_A=0 to +70°C, Unless Otherwise Noted)

Input Timing Measurement Reference Level 1.5 V
 Input Pulse Levels 0 to 3.0 V
 Input Rise/Fall Time 5 ns

Output Timing Measurement Reference Level 1.5 V
 Output Load See Figure 1A Unless Otherwise Noted

READ CYCLE (See Note 1)

Parameter	Symbol	MCM62963A-30		Unit	Notes	
		Min	Max			
Read Cycle Time	t _{KHKH}	30	—	ns	2	
Clock Access Time	t _{KHQV}	—	13	ns	3	
Output Active from Clock High	t _{KHQX}	3	—	ns	4	
Clock High to Q High Z ($\bar{E}=V_{IH}$)	t _{KHQZ}	—	13	ns	4	
Clock Low Pulse Width	t _{CLKL}	5	—	ns		
Clock High Pulse Width	t _{CLKH}	5	—	ns		
Setup Times for:	\bar{E} A \bar{W}	t _{EVKH} t _{AVKH} t _{WHKH}	5	—	ns	5
Hold Times for:	\bar{E} A \bar{W}	t _{KHEX} t _{KHAX} t _{KHWX}	3	—	ns	5

NOTES:

1. A read is defined by \bar{W} high and \bar{E} low for the setup and hold times.
2. All read cycle timing is referenced from K.
3. Valid data from K high will be the data stored at the address of the last valid read cycle.
4. Transition is measured ±500 mV from steady-state voltage with load of Figure 1B. This parameter is sampled not 100% tested. At any given voltage and temperature, t_{KHQZ} max is less than t_{KHQX} min for a given device.
5. This is a synchronous device. All synchronous inputs must meet the specified setup and hold times with stable logic levels for ALL rising edges of clock (K) while the device is selected.

AC TEST LOADS

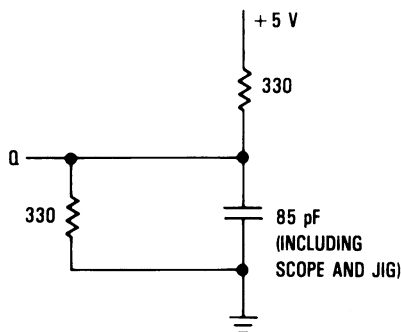

Figure 1A

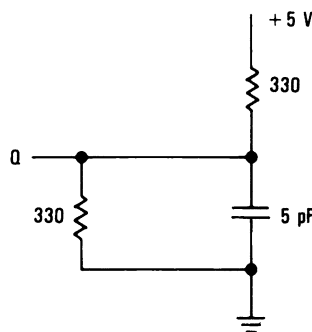
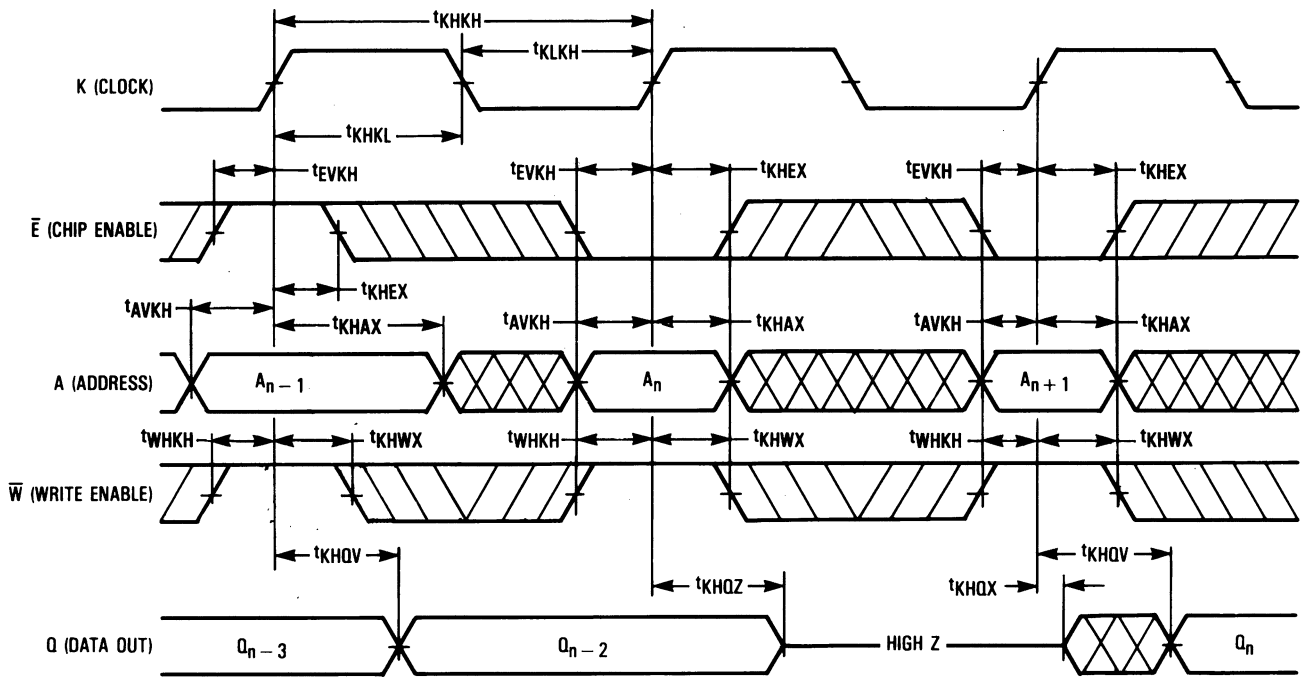
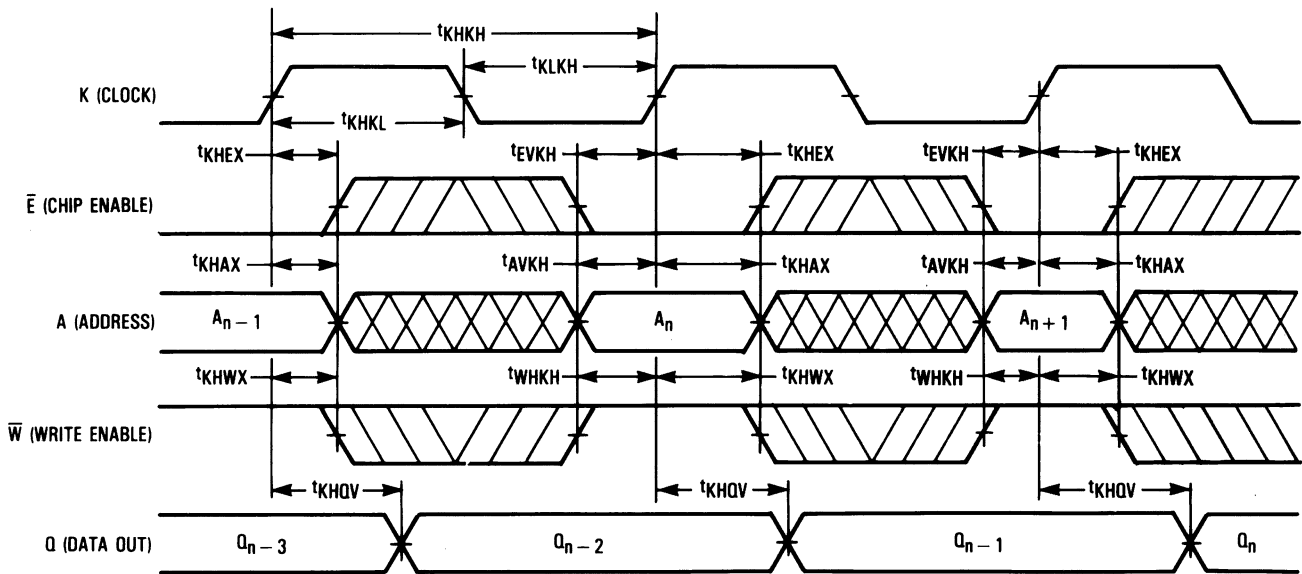

Figure 1B

READ CYCLE 1 (See Note 1)



READ CYCLE 2 (See Note 1)



NOTE:

1. The outputs Q_{n-3} and Q_{n-2} are derived from two previous read cycles where $\bar{W} = V_{IH}$ and $\bar{E} = V_{IL}$ for those cycles.

WRITE CYCLE \overline{W} Controlled. See Note 1†

Parameter	Symbol	MCM62963A-30		Unit	Notes
		Min	Max		
Write Cycle Time	t_{KHKH}	30	—	ns	2
Clock High to Q High Z ($\overline{W} = V_{TL}$)	t_{KHQZ}	—	13	ns	3
Setup Times for:	\overline{E}	t_{EVKH}	—	ns	4
	A	t_{AVKH}			
	\overline{W}	t_{WVKH}			
	D	t_{DVKH}			
Hold Times for:	\overline{E}	t_{KHEX}	—	ns	4
	A	t_{KMAX}			
	\overline{W}	t_{KHWX}			
	D	t_{KHDX}			

NOTES:

1. A write is performed when \overline{W} and \overline{E} are both low for the specified setup and hold times.
2. All write cycle timing is referenced from K.
3. Transition is measured ± 500 mV from steady-state voltage with load of Figure 1B. This parameter is sampled not 100% tested. At any given voltage and temperature, t_{KHQZ} max is less than t_{KHQX} min for a given device.
4. This is a synchronous device. All synchronous inputs must meet the specified setup and hold times with stable logic levels for ALL rising edges of clock (K) while the device is selected.

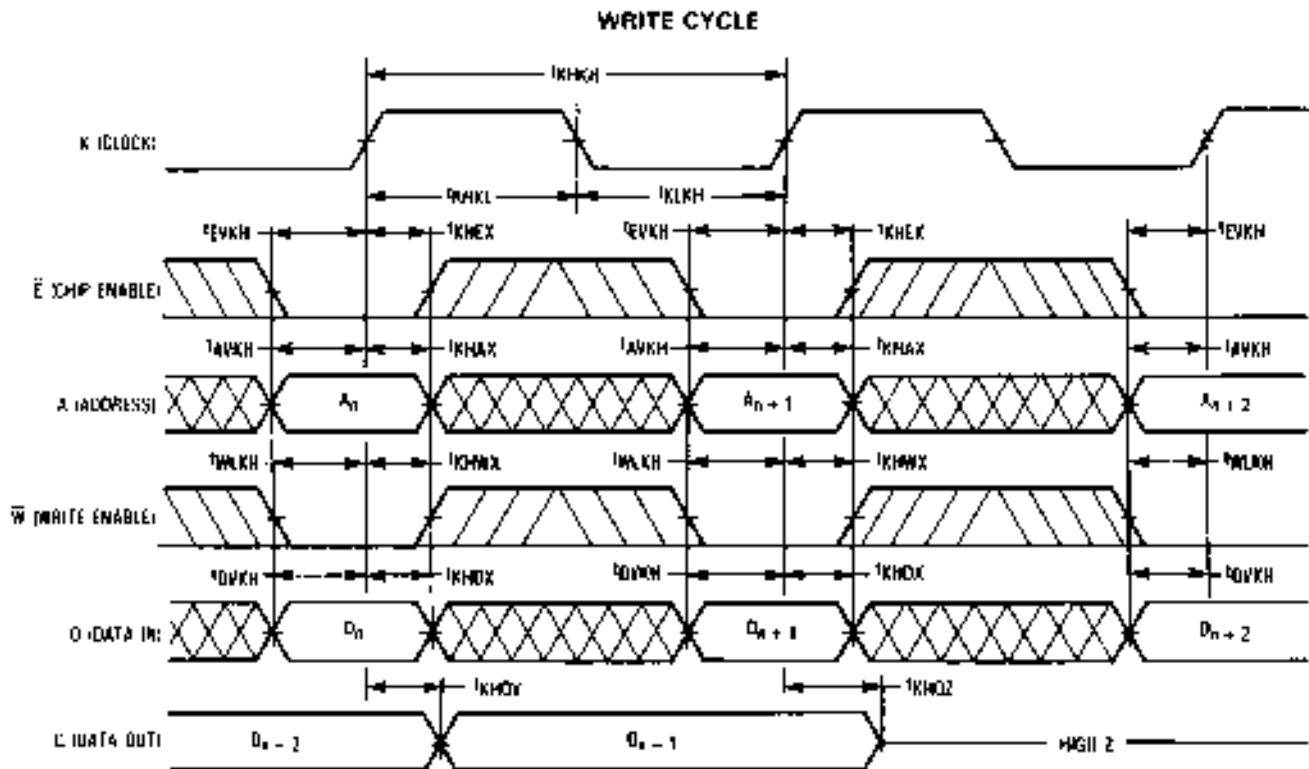

ORDERING INFORMATION
(Order by Full Part Number)

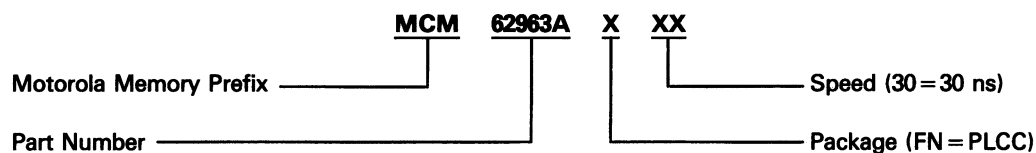

Full Part Number—MCM62963AFN30