

FEATURES

- Micropower 1.5 μ W (1 Sample/Second)
- Wide Supply Range 2.8V to 16V
- High Accuracy
 - Guaranteed SET POINT Error ± 0.5 mV Max.
 - Guaranteed Deadband $\pm 0.1\%$ of Value Max.
- Wide Input Voltage Range V^+ to Ground
- TTL Outputs with 5V Supply
- Two Independent Ground-Referenced Control Inputs
- Small Size 8-Pin MiniDIP

APPLICATIONS

- Temperature Control (Thermostats)
- Motor Speed Control
- Battery Charger
- Any ON-OFF Control Loop

DESCRIPTION

The LTC1041 is a monolithic CMOS BANG-BANG controller manufactured using Linear Technology's enhanced LTCMOSTM silicon gate process. BANG-BANG loops are characterized by turning the control element fully ON or fully OFF to regulate the average value of the parameter to be controlled. The SET POINT input determines the average control value and the DELTA input sets the deadband. The deadband is always $2 \times$ DELTA and is centered around the SET POINT. Independent control of the SET POINT and deadband, with no interaction, is made possible by the unique sampling input structure of the LTC1041.

An external RC connected to the OSC pin sets the sampling rate. At the start of each sample, internal power to the analog section is switched on for $\approx 80\mu$ s. During this time the analog inputs are sampled and compared. After the comparison is complete, power is switched off. This achieves extremely low average power consumption at low sampling rates. CMOS logic holds the output continuously while consuming virtually no power.

To keep system power at an absolute minimum, a switched power output (V_{PP}) is provided. External loads, such as bridge networks and resistive dividers, can be driven by this switched output.

The output logic sense (i.e., ON = V^+) can be reversed (i.e., ON = GND) by interchanging the V_{IN} and SET POINT inputs. This has no other effect on the operation of the LTC1041.

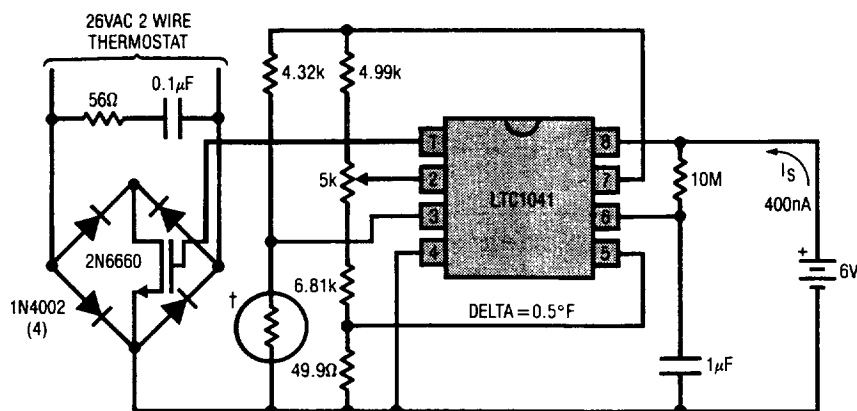
6
Ultra Low Power 50°F to 100°F (2.4 μ W) Thermostat

ALL RESISTORS 1%.
 †YELLOW SPRINGS INSTRUMENT CO., INC. P/N 44007
 DRIVING THERMISTOR WITH V_{PP} ELIMINATES 3.8°F
 ERROR DUE TO SELF-HEATING.

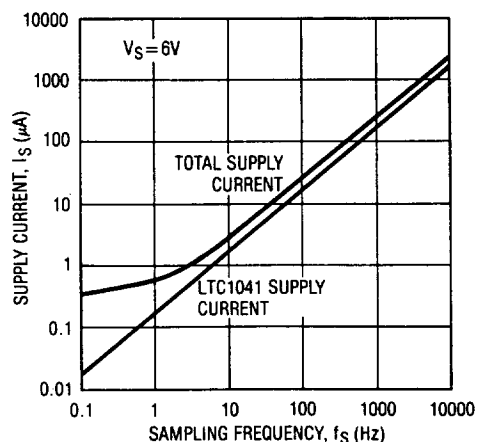
Supply Current vs Sampling Frequency

LTCMOSTM is a trademark of Linear Technology Corporation.

ABSOLUTE MAXIMUM RATINGS

Total Supply Voltage (V^+ to V^-)	18V
Input Voltage (V^+ + 0.3V) to (V^- - 0.3V)	
Operating Temperature Range	
LTC1041C	-40°C to 85°C
LTC1041M	-55°C to 125°C
Storage Temperature Range	-55°C to 150°C
Lead Temperature (Soldering, 10 sec.)	300°C
Output Short Circuit Duration	Continuous

PACKAGE/ORDER INFORMATION

	TEMPERATURE RANGE	ORDER PART NUMBER
	-55°C to 125°C -40°C to 85°C	LTC1041MJ8 LTC1041CN8

ELECTRICAL CHARACTERISTICS

Test Conditions: $V^+ = 5V$, $T_{MIN} \leq T_A \leq T_{MAX}$ unless otherwise specified.

SYMBOL	PARAMETER	CONDITIONS	LTC1041M/LTC1041C			UNITS	
			MIN	TYP	MAX		
●	SET POINT Error (Note 2)	$V^+ = 2.8V$ to $6V$ (Note 1)		± 0.3 +	± 0.5 +	mV	
				± 0.05	± 0.1	% of DELTA	
●		$V^+ = 6V$ to $15V$ (Note 1)		± 1 +	± 3 +	mV	
				± 0.05	± 0.1	% of DELTA	
●	Deadband Error (Note 3)	$V^+ = 2.8V$ to $6V$ (Note 1)		± 0.6 +	± 1 +	mV	
				± 0.1	± 0.2	% of DELTA	
●		$V^+ = 6V$ to $15V$ (Note 1)		± 2 +	± 6 +	mV	
				± 0.1	± 0.2	% of DELTA	
I_{OS}	Input Current	$V^+ = 5V$, $T_A = 25^\circ C$, OSC = GND (V_{IN} , SET POINT and DELTA Inputs)		± 0.3		nA	
R_{IN}	Equivalent Input Resistance	$f_S = 1kHz$ (Note 4)	●	10	15	M Ω	
	Input Voltage Range		●	GND	V^+	V	
PSR	Power Supply Range		●	2.8	16	V	
$I_{S(ON)}$	Power Supply ON Current (Note 5)	$V^+ = 5V$, V_{PP} ON	●		1.2	3	mA
$I_{S(OFF)}$	Power Supply OFF Current (Note 5)	$V^+ = 5V$, V_{PP} OFF	●		0.001	0.5	μA
			●		0.001	5	μA
t_D	Response Time (Note 6)	$V^+ = 5V$		60	80	100	μs
V_{OH} V_{OL}	ON/OFF Output (Note 7)	$V^+ = 4.75V$, $I_{OUT} = -360\mu A$ $V^+ = 4.75V$, $I_{OUT} = 1.6mA$	●	2.4	4.4		V
	Logical '1' Output Voltage				0.25	0.4	
R_{EXT}	External Timing Resistor	Resistor Connected between V^+ and OSC Pin	●	100		10,000	k Ω
f_S	Sampling Frequency	$V^+ = 5V$, $T_A = 25^\circ C$, $R_{EXT} = 1M$ $C_{EXT} = 0.1\mu F$			5		Hz

The ● denotes the specifications which apply over the full operating temperature range. The shaded electrical specifications indicate those parameters which have been improved or guaranteed test limits provided for the first time.

Note 1: Applies over input voltage range limit and includes gain uncertainty.

Note 2: SET POINT error $\equiv \left(\frac{V_U + V_L}{2} \right) - \text{SET POINT}$

where V_U = upper band limit and V_L = lower band limit.

Note 3: Deadband error $\equiv (V_U - V_L) - 2 \times \text{DELTA}$ where V_U = upper band limit and V_L = lower band limit.

Note 4: R_{IN} is guaranteed by design and is not tested.
 $R_{IN} = 1 / (f_S \times 66pF)$.

Note 5: Average supply current $= t_D \times I_{S(ON)} \times f_S + (1 - t_D \times f_S) I_{S(OFF)}$.

Note 6: Response time is set by an internal oscillator and is independent of overdrive voltage. $t_D = V_{PP}$ pulse width.

Note 7: Output also capable of meeting EIA/JEDEC standard B series CMOS drive specifications.

TYPICAL PERFORMANCE CHARACTERISTICS

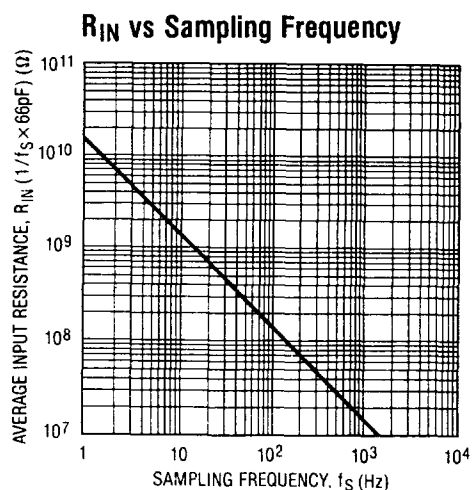
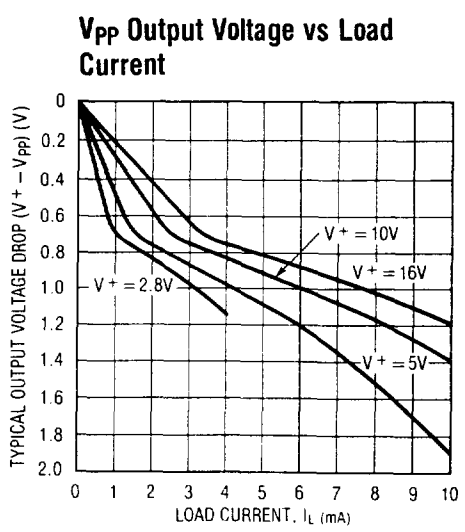
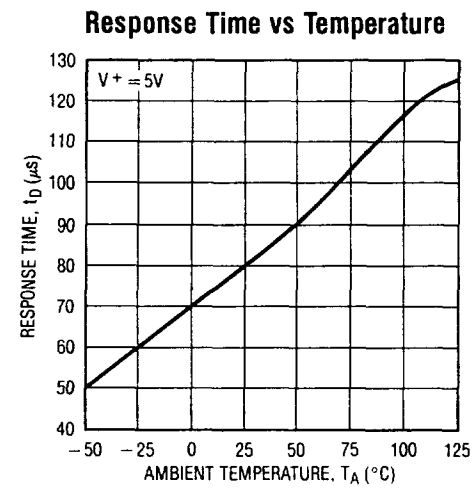
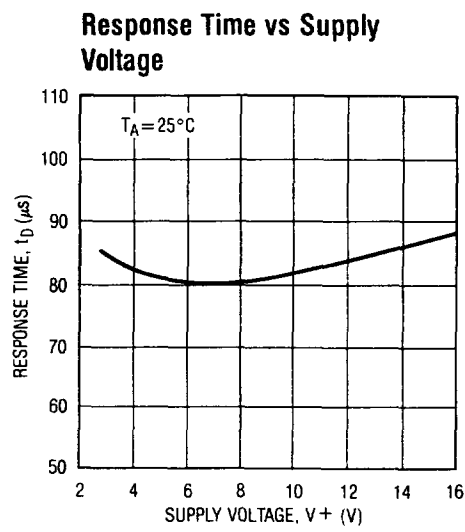
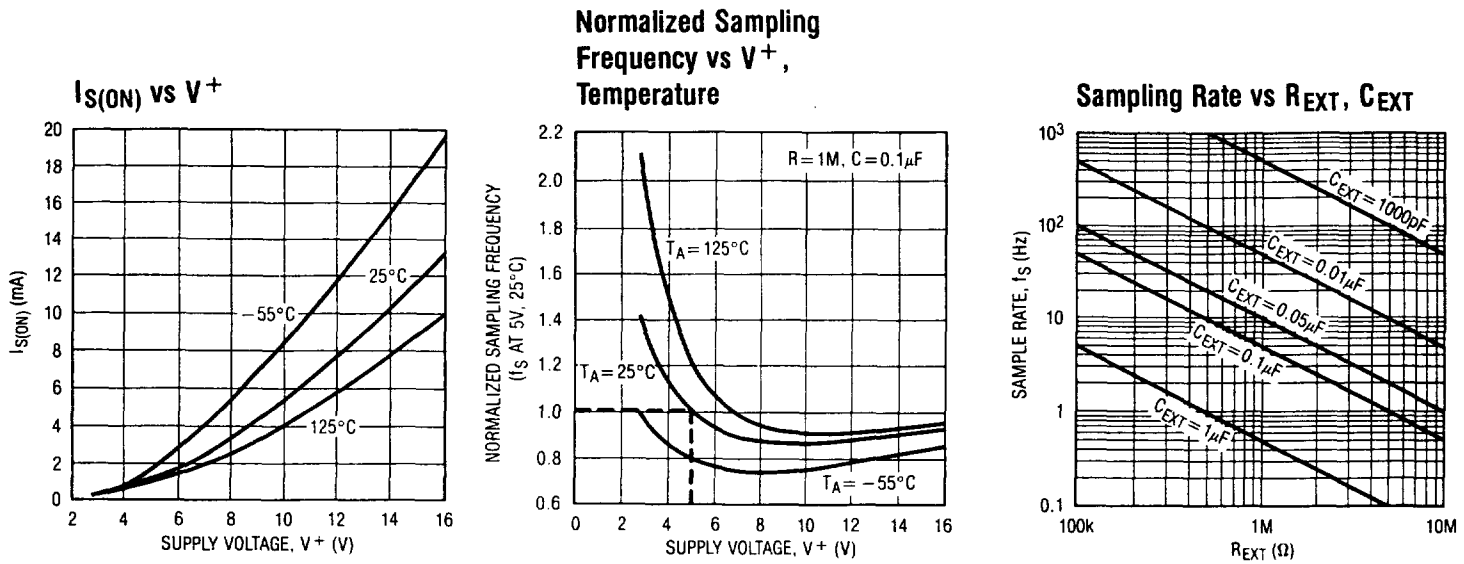

6

APPLICATIONS INFORMATION

The LTC1041 uses sampled data techniques to achieve its unique characteristics. It consists of two comparators, each of which has two differential inputs (Figure 1). When the sum of the voltages on a comparator's inputs is positive, the output is high and when the sum is negative, the output is low. The inputs are interconnected such that the RS flip-flop is reset ($ON/\overline{OFF} = GND$) when $V_{IN} > (SET\ POINT + \Delta)$ and is set ($ON/\overline{OFF} = V^+$) when $V_{IN} < (SET\ POINT - \Delta)$. This makes a very precise hysteresis loop of $2 \times \Delta$ centered around the SET POINT. See Figure 1(b).

For $R_S < 10k\Omega$

The dual differential input structure is made with CMOS switches and a precision capacitor array. Input impedance characteristics of the LTC1041 can be determined from the equivalent circuit shown in Figure 2. The input capacitance will charge with a time constant of $R_S \times C_{IN}$. The ability to fully charge C_{IN} from the signal source during the controller's active time is critical in determining errors caused by the input charging current. For source resistances less than $10k\Omega$, C_{IN} fully charges and no error is caused by the charging current.

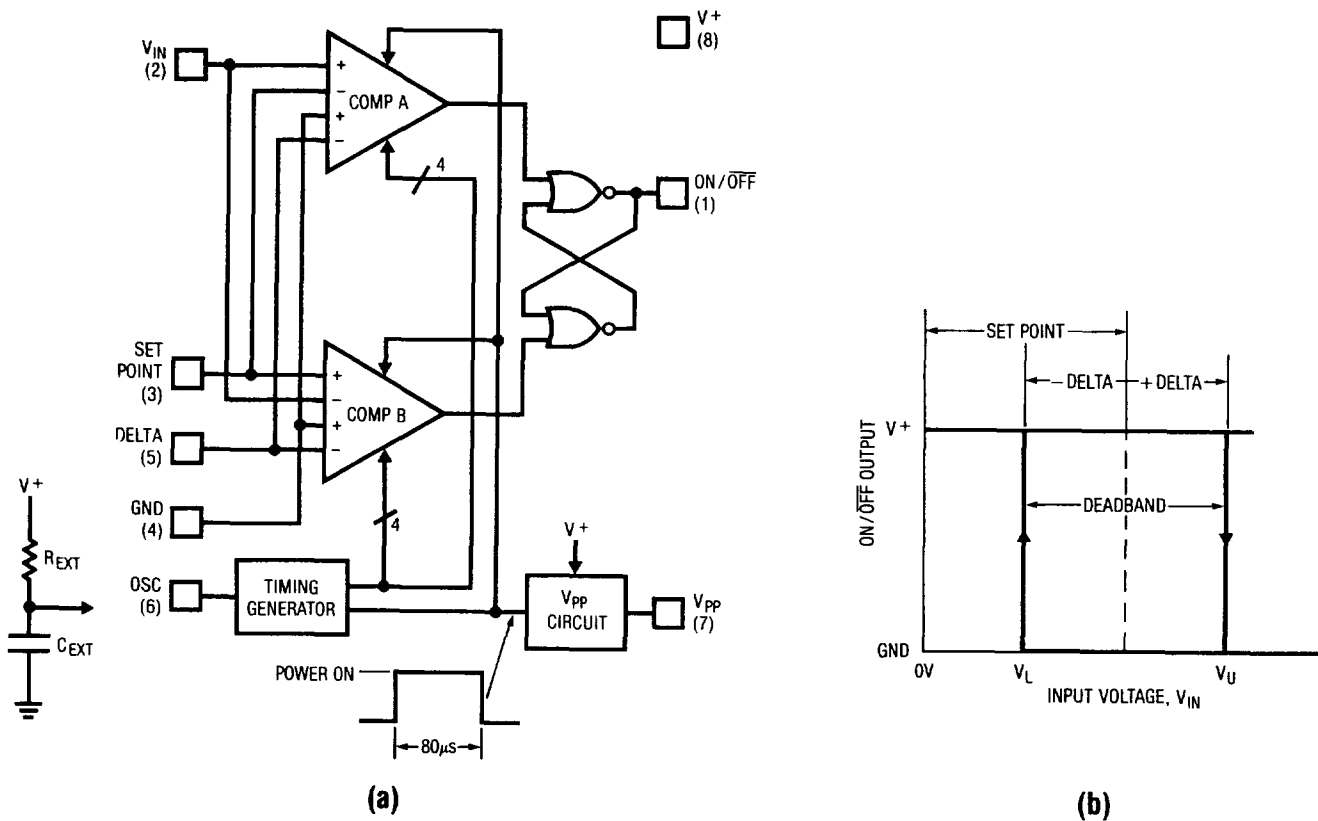

Figure 1. LTC1041 Block Diagram

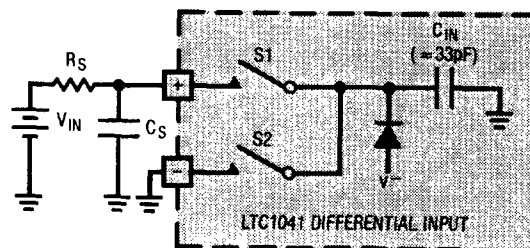

Figure 2. Equivalent Input Circuit

APPLICATIONS INFORMATION

For $R_S > 10k\Omega$

For source resistances greater than $10k\Omega$, C_{IN} cannot fully charge, causing voltage errors. To minimize these errors, an input bypass capacitor, C_S , should be used. Charge is shared between C_{IN} and C_S , causing a small voltage error. The magnitude of this error is $\Delta V = V_{IN} \times C_{IN} / (C_{IN} + C_S)$. This error can be made arbitrarily small by increasing C_S .

The averaging effect of the bypass capacitor, C_S , causes another error term. Each time the input switches cycle between the plus and minus inputs, C_{IN} is charged and discharged. The average input current due to this is $I_{AVG} = V_{IN} \times C_{IN} \times f_S$, where f_S is the sampling frequency. Because the input current is directly proportional to the differential input voltage, the LTC1041 can be said to have an average input resistance of $R_{IN} = V_{IN} / I_{AVG} = 1 / (f_S \times C_{IN})$.

Since two comparator inputs are connected in parallel, R_{IN} is one half of this value (see typical curve of R_{IN} versus f_S). This finite input resistance causes an error due to the voltage divider between R_S and R_{IN} .

The input voltage error caused by both of these effects is $V_{ERROR} = V_{IN} [2C_{IN} / (2C_{IN} + C_S) + R_S / (R_S + R_{IN})]$.

Example: assume $f_S = 10\text{Hz}$, $R_S = 1\text{M}$, $C_S = 1\mu\text{F}$, $V_{IN} = 1\text{V}$, $V_{ERROR} = 1\text{V}(66\mu\text{V} + 660\mu\text{V}) = 726\mu\text{V}$. Notice that most of the error is caused by R_{IN} . If the sampling frequency is reduced to 1Hz , the voltage error from the input impedance effects is reduced to $136\mu\text{V}$.

Input Voltage Range

The input switches of the LTC1041 are capable of switching either to the V^+ supply or ground. Consequently, the input voltage range includes both supply rails. This is a further benefit of the sampling input structure.

Error Specifications

The only measurable errors on the LTC1041 are the deviations from "ideal" of the upper and lower switching levels [Figure 1(b)]. From a control standpoint, the error

in the SET POINT and deadband is critical. These errors may be defined in terms of V_U and V_L .

$$\text{SET POINT error} \equiv \left(\frac{V_U + V_L}{2} \right) - \text{SET POINT}$$

$$\text{deadband error} \equiv (V_U - V_L) - 2 \times \text{DELTA}$$

The specified error limits (see electrical characteristics) include error due to offset, power supply variation, gain, time and temperature.

Pulsed Power (V_{PP}) Output

It is often desirable to use the LTC1041 with resistive networks such as bridges and voltage dividers. The power consumed by these resistive networks can far exceed that of the LTC1041 itself.

At low sample rates the LTC1041 spends most of its time off. A switched power output, V_{PP} , is provided to drive the input network, reducing its average power as well. V_{PP} is switched to V^+ during the controller's active time ($\approx 80\mu\text{s}$) and to a high impedance (open circuit) when internal power is switched off.

Figure 3 shows the V_{PP} output circuit. The V_{PP} output voltage is not precisely controlled when driving a load (see typical curve of V_{PP} output voltage versus load current). In spite of this, high precision can be achieved in two ways: (1) driving ratiometric networks and (2) driving fast settling references.

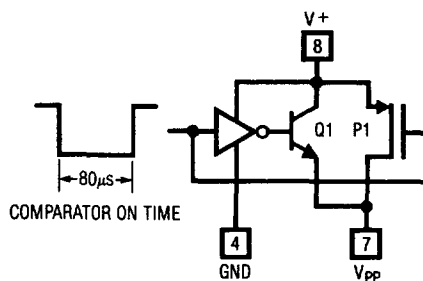

Figure 3. V_{PP} Output Switch

APPLICATIONS INFORMATION

In ratiometric networks (Figure 4) all the inputs are proportional to V_{PP} . Consequently, the absolute value of V_{PP} does not affect accuracy.

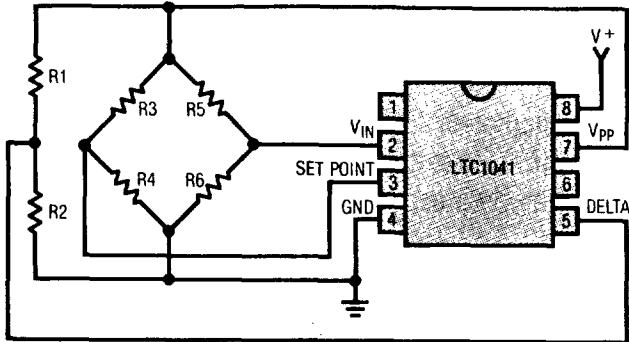

Figure 4. Ratiometric Network Driven by V_{PP}

If the best possible performance is needed, the inputs to the LTC1041 must completely settle within $4\mu s$ of the start of the comparison cycle (V_{PP} high impedance to V^+ transition). Also, it is critical that the input voltages do not change during the $80\mu s$ active time. When driving resistive input networks with V_{PP} , capacitive loading should be minimized to meet the $4\mu s$ settling time requirement. Further, care should be exercised in layout when driving networks with source impedances, as seen by the LTC1041, of greater than $10k\Omega$ (see For $R_s > 10k\Omega$).

In applications where an absolute reference is required, the V_{PP} output can be used to drive a fast settling reference. The LTC1009 2.5V reference settles in $\approx 2\mu s$ and is ideal for this application (Figure 5). The current through $R1$ must be large enough to supply the LT1009 minimum bias current ($\approx 1mA$) and the load current, I_L .

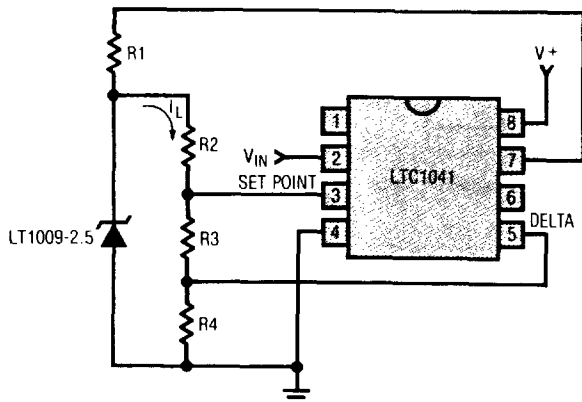

Figure 5. Driving Reference with V_{PP} Output

Internal Oscillator

An internal oscillator allows the LTC1041 to strobe itself. The frequency of the oscillation, and hence the sampling rate, is set with an external RC network (see typical curve, OSC frequency versus R_{EXT} , C_{EXT}). R_{EXT} and C_{EXT} are connected as shown in Figure 1. To assure oscillation, R_{EXT} must be between $100k\Omega$ and $10M\Omega$. There is no limit to the size of C_{EXT} .

At low sampling rates, R_{EXT} is very important in determining the power consumption. R_{EXT} consumes power continuously. The average voltage at the OSC pin is approximately $V^+ / 2$, giving a power dissipation of $P_{REXT} = (V^+ / 2)^2 / R_{EXT}$.

Example: assume $R_{EXT} = 1M\Omega$, $V^+ = 5V$, $P_{REXT} = (2.5)^2 / 10^6 = 6.25\mu W$. This is approximately four times the power consumed by the LTC1041 at $V^+ = 5V$ and $f_s = 1$ sample/second. Where power is a premium, R_{EXT} should be made as large as possible. Note that the power dissipated by R_{EXT} is *not* a function of f_s or C_{EXT} .

If high sampling rates are needed and power consumption is of secondary importance, a convenient way to get the maximum possible sampling rate is to make $R_{EXT} = 100k\Omega$ and $C_{EXT} = 0$. The sampling rate, set by the controller's active time, will nominally be $\approx 10kHz$.

To synchronize the sampling of the LTC1041 to an external frequency source, the OSC pin can be driven by a CMOS gate. A CMOS gate is necessary because the input trip points of the oscillator are close to the supply rails and TTL does not have enough output swing. Externally driven, there will be a delay from the rising edge of the OSC input and the start of the sampling cycle of approximately $5\mu s$.

PACKAGE DESCRIPTION Dimensions in inches (millimeters) unless otherwise noted.

**J Package
8 Lead Hermetic DIP**

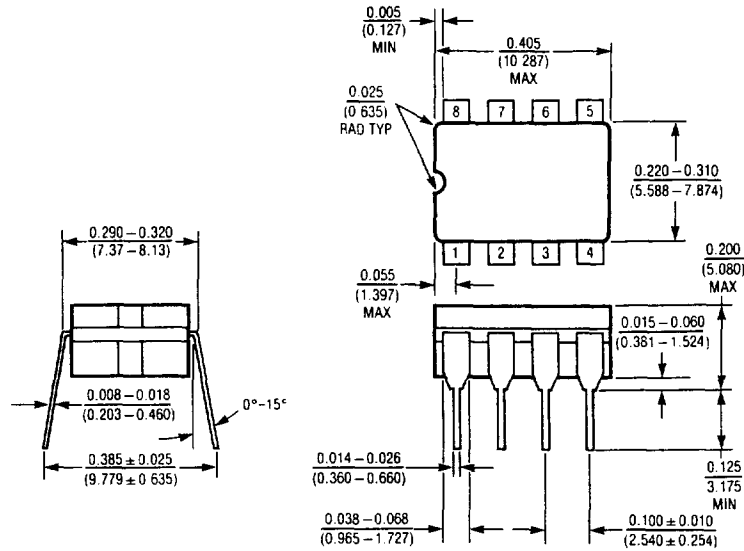

J8188

T_{jmax} 150°C	Θ_{JA} 100°C/W
---------------------	--------------------------

**N Package
8 Lead Plastic**

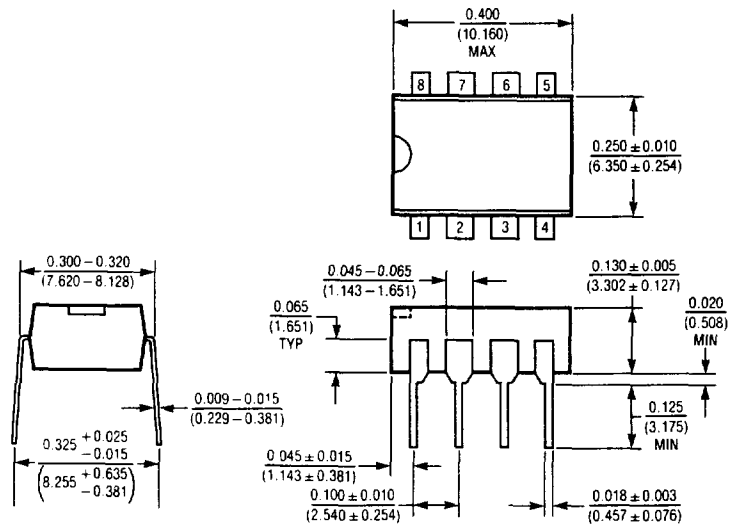

N8188

T_{jmax} 110°C	Θ_{JA} 150°C/W
---------------------	--------------------------