

**DG426/A, DG429/A, DG433/A,
 DG434/A, DG440/A, DG441/A,
 DG451/A, DG452/A,
 DG453/A, DG454/A**
**2-Channel Drivers with
 SPST and DPST
 FET Switches**

FEATURES

- Each channel complete—interfaces with most integrated logic
- **Low OFF power dissipation, — 1mW**
- Switches analog signals up to 16 volts peak-to-peak
- Low $r_{DS(ON)}$, 15 ohms max on DG440/A and DG441/A
- Switching times improved 100%—"A" versions

GENERAL DESCRIPTION

These switching circuits contain two channels in one package, each channel consisting of a driver circuit controlling a SPST or DPST junction FET switch. The driver interfaces DTL, TTL or RTL logic signals for multiplexing, commutating, and D/A converter applications, which permits logic design directly with the switch function. Logic "1" at the input turns the FET switch ON, and logic "0" turns it OFF.

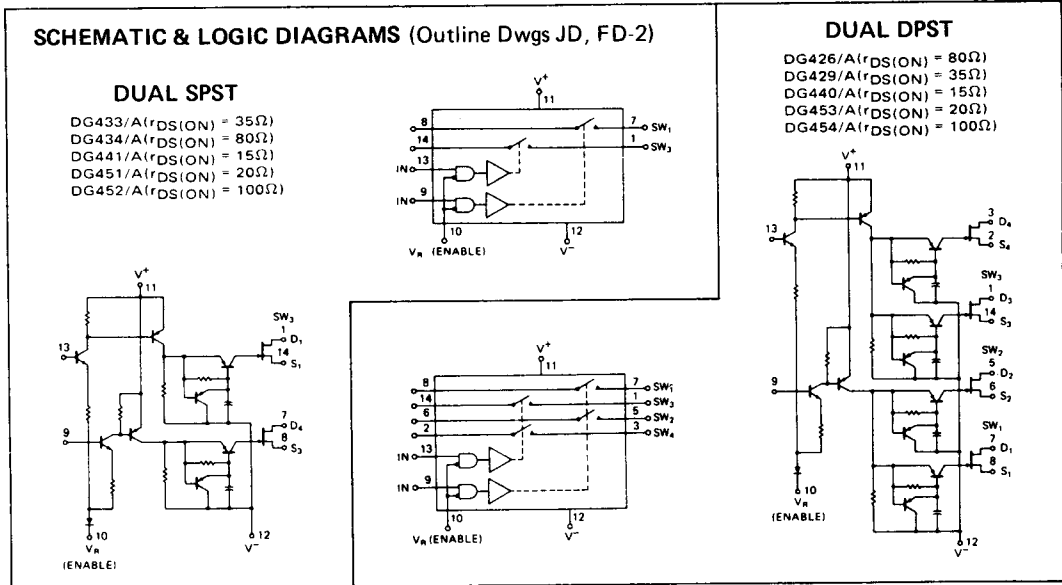

ORDERING INFORMATION

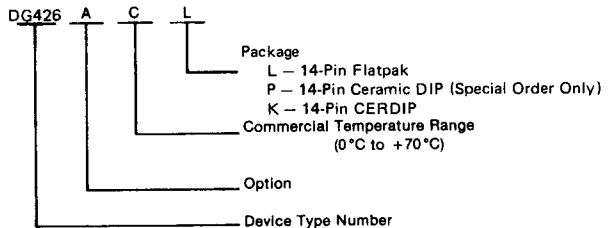

ABSOLUTE MAXIMUM RATINGS

Analog Signal Voltage ($V_A - V^-$ or $V^+ - V_A$)	28V
Total Supply Voltage ($V^+ - V^-$)	32V
Pos. Supply Voltage to Ref. Voltage ($V^+ - V_R$)	18V
Ref. Voltage to Neg. Supply Voltage ($V_R - V^-$)	21V
Power Dissipation (Note)	750 mW
Current (any terminal)	30 mA

Storage Temperature	-65 to +150
Operating Temperature	-65 to +150
Lead Temperature (soldering, 10 sec.)	300

NOTE: Dissipation rating assumes device is mounted with all leads welded or soldered to printed circuit board in ambient temperature below 70°C.

Stresses above those listed under Absolute Maximum Ratings may cause permanent damage to the device. These are stress ratings only and functional operation of the device at these or any other conditions above those indicated in the operational sections of the specifications is not implied. Exposure to absolute maximum rating conditions for extended periods may affect device reliability.

3 ELECTRICAL CHARACTERISTICS PER CHANNEL

Applied voltages for all tests: DG426, DG429, DG433, DG434, DG440, DG441, ($V^+ = +12V, V^- = -18V, V_R = 0$) and DG445, DG452, DG453, DG454 ($V^+ = +15V, V^- = -15V, V_R = 0$). Input test condition which guarantees FET switch ON and OFF specified is used for output and power supply specifications.

	SYMBOL (NOTE)	CHARACTERISTIC	TYPE	ABSOLUTE MAX. LIMIT			UNITS	TEST CONDITIONS
				0°	25°	70°		
INPUT	$V_{IN(ON)}$	Input Voltage-On	All Circuits	2.9 min	2.5 min	2.0 min	Volts	$V_2 = -12V$
	$V_{IN(OFF)}$	Input Voltage-Off		1.4	1.0	0.8	Volts	$V_2 = -12V$
	$I_{IN(ON)}$	Input Current		150	100	100	μA	$V_{IN} = 2.5V$
	$I_{IN(OFF)}$	Input Leakage Current		4	4	10	μA	$V_{IN} = 0.8V$
SWITCH	$r_{DS(ON)}$	Drain-Source On Resistance	DG426/A DG434/A	80	80	130	Ω	$V_D = 8V, I_S = 10 mA$
			DG429/A DG433/A	35	35	50	Ω	
			DG440/A DG441/A	15	15	25	Ω	
			DG451/A DG453/A	20	20	30	Ω	$V_D = 5.5V, I_S = 10 mA$
			DG452/A DG454/A	100	100	140	Ω	
	$I_{D(ON)} + I_{S(ON)}$	Drive Leakage Current	DG426/A		5	160	nA	$V_D = V_S = -8V$
	$I_{S(OFF)}$	Source Leakage Current	DG429/A DG433/A		5	160	nA	$V_S = 8V, V_D = -8V$
	$I_{D(OFF)}$	Drain Leakage Current	DG434/A		5	160	nA	$V_D = 8V, V_S = -8V$
	$I_{D(ON)} + I_{S(ON)}$	Drive Leakage Current	DG440/A DG441/A		5	160	nA	$V_D = V_S = -8V$
	$I_{S(OFF)}$	Source Leakage Current		15	500	nA	$V_S = 8V, V_D = -8V$	
$I_{D(OFF)}$	Drain Leakage Current		15	500	nA	$V_D = 8V, V_S = -8V$		
$I_{D(ON)} + I_{S(ON)}$	Drive Leakage Current	DG451/A DG453/A		5	100	nA	$V_D = V_S = -5.5V$	
$I_{S(OFF)}$	Source Leakage Current		15	300	nA	$V_S = 5.5V, V_D = -5.5V$		
$I_{D(OFF)}$	Drain Leakage Current		15	300	nA	$V_D = 5.5V, V_S = -5.5V$		
$I_{D(ON)} + I_{S(ON)}$	Drive Leakage Current	DG452/A DG454/A		5	100	nA	$V_D = V_S = -5.5V$	
$I_{S(OFF)}$	Source Leakage Current		5	100	nA	$V_S = 5.5V, V_D = -5.5V$		
$I_{D(OFF)}$	Drain Leakage Current		5	100	nA	$V_D = 5.5V, V_S = -5.5V$		
POWER SUPPLY	$I_{1(ON)}$	Positive Power Supply Drain Current	All Circuits		3.5		mA	One Driver ON, $V_{IN} = 2.5V$
	$I_{2(ON)}$	Negative Power Supply Drain Current			-2.0		mA	
	$I_{R(ON)}$	Reference Power Supply Drain Current			-1.5		mA	
	$I_{1(OFF)}$	Positive Power Supply Leakage Current			25		μA	Both Drivers OFF, $V_{IN} = 0.8V$
	$I_{2(OFF)}$	Negative Power Supply Leakage Current			-25		μA	
$I_{R(OFF)}$	Reference Power Supply Leakage Current		-25		μA			

NOTE: (OFF) and (ON) subscript notation refers to the conduction state of the FET switch for the given test.

ELECTRICAL CHARACTERISTICS PER CHANNEL (cont.)

SYMBOL (NOTE)	CHARACTERISTIC	TYPE	ABSOLUTE MAX. LIMIT			UNITS	TEST CONDITIONS
			0°	25°	70°		
t _{ON}	Turn-On Time	DG426, DG429 DG433, DG434 DG452, DG454		1.0		μs	See Below
		DG426A, DG429A DG433A, DG434A DG452A, DG454A		0.5	0.7	μs	
t _{OFF}	Turn-Off Time	DG426, DG429 DG433, DG434 DG452, DG454		2.0		μs	See Below
		DG426A, DG429A DG433A, DG434A DG452A, DG454A		1.0	1.3	μs	
t _{ON}	Turn-On Time	DG440, DG441 DG451, DG453		1.5		μs	See Below
		DG440A, DG441A DG451A, DG453A		.75	1.3	μs	
t _{OFF}	Turn-Off Time	DG440, DG441 DG451, DG453		2.5		μs	See Below
		DG440A, DG441A DG451A, DG453A		1.25	1.8	μs	
P _{ON}	ON Drive Power	All Circuits		175		mW	Both Inputs V _{IN} = 2.5V
P _{OFF}	OFF Driver Power			1		mW	Both Inputs V _{IN} = 1.0V

NOTE: (OFF) and (ON) subscript notation refers to the conduction state of the FET switch for the given test.

SWITCHING TIMES (at 25°C)

DG426/A, 429/A, 433/A, 434/A, 440/A, 441/A

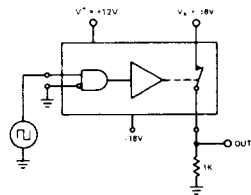
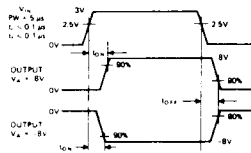

OFF MODEL

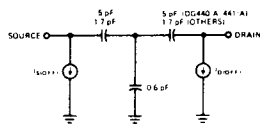

ON MODEL

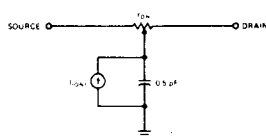

DG451/A, 452/A, 453/A, 454/A

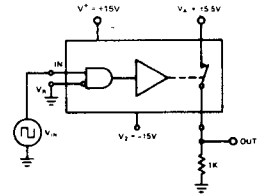
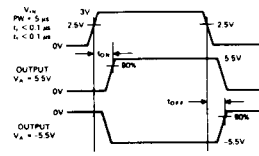

OFF MODEL

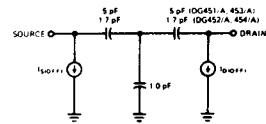

ON MODEL

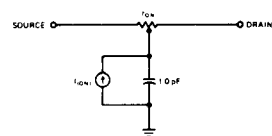

TYPICAL CHARACTERISTICS (per channel)

DG426/A, 429/A, 433/A, 434/A, 440/A, 441/A

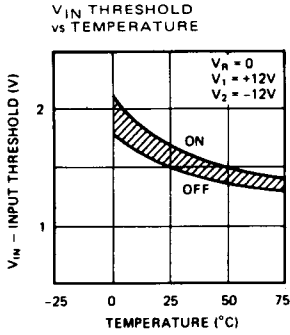

DG451/A, 452/A, 453/A, 454/A

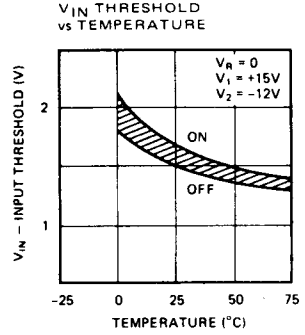

3

$r_{DS(ON)}$ vs TEMPERATURE
(Normalized to 25 $^{\circ}$ C Value)

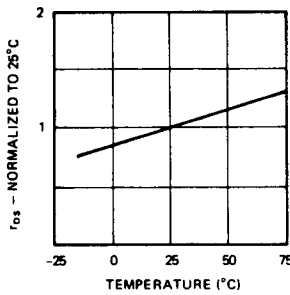

$I_D(OFF)$ vs TEMPERATURE

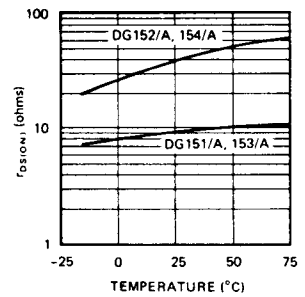

ALL CIRCUITS

ON SUPPLY CURRENT vs TEMPERATURE

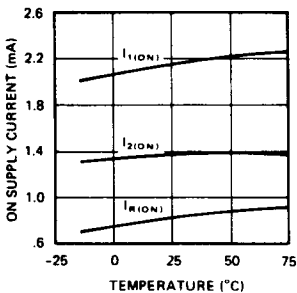

$r_{DS(ON)}$ vs TEMPERATURE

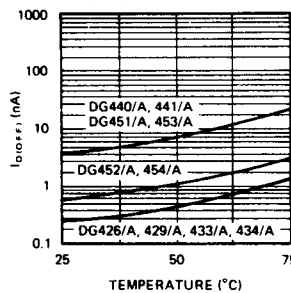

OFF SUPPLY CURRENT vs TEMPERATURE

