

# 2SC4130

Silicon NPN Epitaxial Planar Transistor (High Voltage and High Speed Switching Transistor)

Application : Switching Regulator and General Purpose

**Absolute maximum ratings** (Ta=25°C)

Symbol	2SC4130	Unit
V <sub>CB0</sub>	500	V
V <sub>CEO</sub>	400	V
V <sub>EB0</sub>	10	V
I <sub>C</sub>	7(Pulse14)	A
I <sub>B</sub>	2	A
P <sub>C</sub>	30(Tc=25°C)	W
T <sub>J</sub>	150	°C
T <sub>stg</sub>	-55 to +150	°C

**Electrical Characteristics** (Ta=25°C)

Symbol	Conditions	2SC4130	Unit
I <sub>CBO</sub>	V <sub>CB</sub> =500V	100max	μA
I <sub>EBO</sub>	V <sub>EB</sub> =10V	100max	μA
V <sub>(BR)CEO</sub>	I <sub>C</sub> =25mA	400min	V
h <sub>FE</sub>	V <sub>CE</sub> =4V, I <sub>C</sub> =3A	10to30	
V <sub>CE(sat)</sub>	I <sub>C</sub> =3A, I <sub>B</sub> =0.6A	0.5max	V
V <sub>BE(sat)</sub>	I <sub>C</sub> =3A, I <sub>B</sub> =0.6A	1.3max	V
f <sub>r</sub>	V <sub>CE</sub> =12V, I <sub>E</sub> =-0.5A	15typ	MHz
COB	V <sub>CB</sub> =10V, f=1MHz	50typ	pF

**External Dimensions FM20(TO220F)**

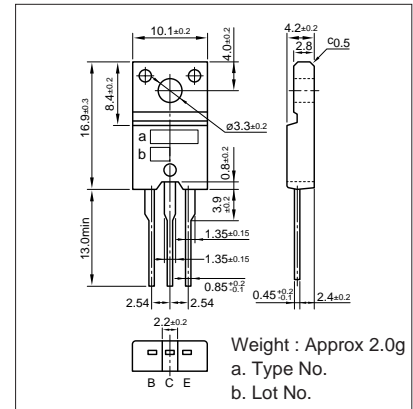

**Typical Switching Characteristics (Common Emitter)**

V <sub>CC</sub> (V)	R <sub>L</sub> (Ω)	I <sub>C</sub> (A)	V <sub>BB1</sub> (V)	V <sub>BB2</sub> (V)	I <sub>B1</sub> (A)	I <sub>B2</sub> (A)	t <sub>on</sub> (μs)	t <sub>stg</sub> (μs)	t <sub>r</sub> (μs)
200	67	3	10	-5	0.3	-0.6	1max	2.2max	0.5max

**I<sub>C</sub>-V<sub>CE</sub> Characteristics (Typical)**

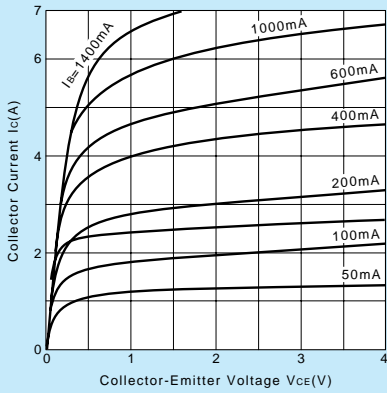

**V<sub>CE(sat)</sub>, V<sub>BE(sat)</sub>-I<sub>C</sub> Temperature Characteristics (Typical)**

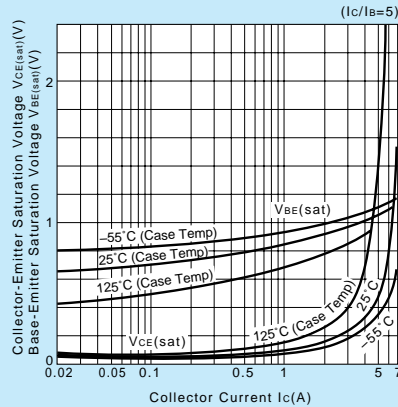

**I<sub>C</sub>-V<sub>BE</sub> Temperature Characteristics (Typical)**

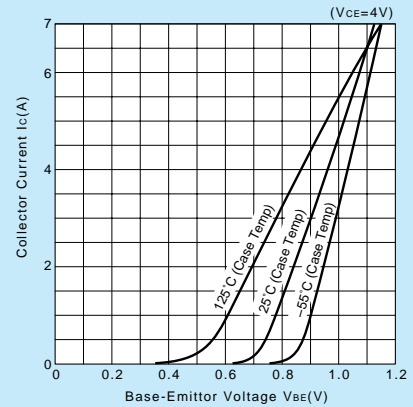

**h<sub>FE</sub>-I<sub>C</sub> Characteristics (Typical)**

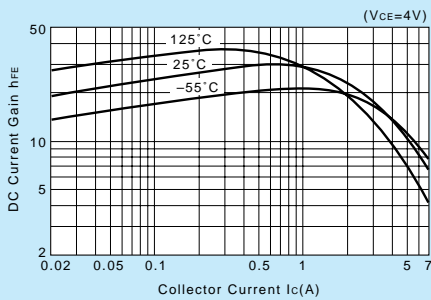

**t<sub>on</sub>•t<sub>stg</sub>•t<sub>r</sub>-I<sub>C</sub> Characteristics (Typical)**

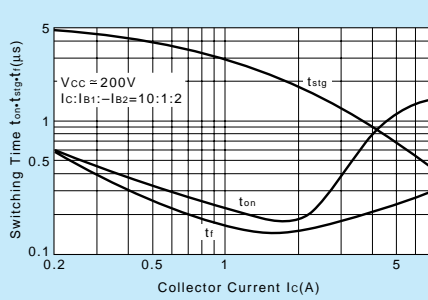

**θ<sub>J-a</sub>-t Characteristics**

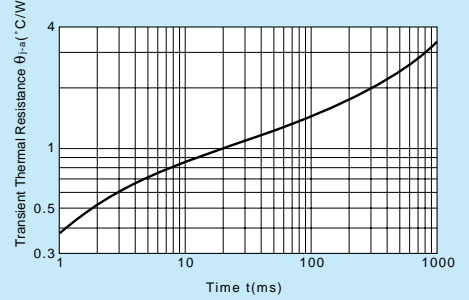

**Safe Operating Area (Single Pulse)**

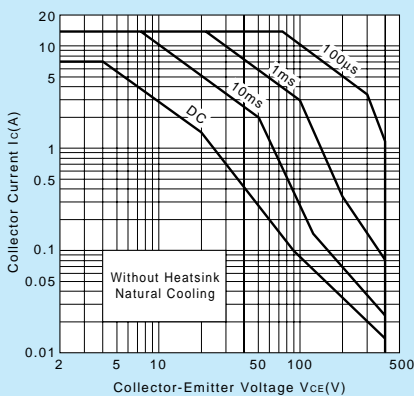

**Reverse Bias Safe Operating Area**

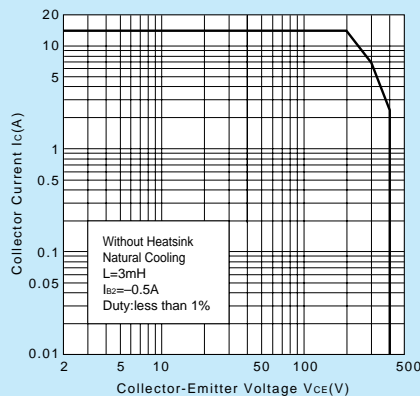

**P<sub>C</sub>-T<sub>a</sub> Derating**

