

TOSHIBA BIPOLAR LINEAR INTEGRATED CIRCUIT SILICON MONOLITHIC

TA8189N

QUAD PREAMPLIFIER FOR DOUBLE CASSETTE TAPE RECORDER

The TA8189N is a Quad pre amplifier designed for use in record /play back amplifier. It is suitable for double cassette tape recorder.

FEATURES

- Play back Amp
 - Built in input select switch.
 - Built in equalizer control switch.
 - Mixing output, for music selection.
- Recording Amp
 - Built in ALC detector circuit.
- Operating supply voltage range : $V_{CC}(\text{opr}) = 4.0 \sim 13.5\text{V}$ ($T_a = 25^\circ\text{C}$)

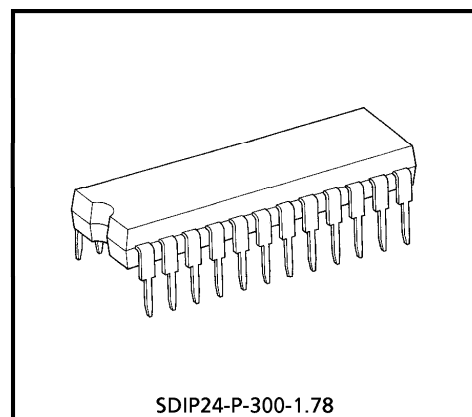

SDIP24-P-300-1.78

Weight : 1.2g (Typ.)

961001EBA2

- TOSHIBA is continually working to improve the quality and the reliability of its products. Nevertheless, semiconductor devices in general can malfunction or fail due to their inherent electrical sensitivity and vulnerability to physical stress. It is the responsibility of the buyer, when utilizing TOSHIBA products, to observe standards of safety, and to avoid situations in which a malfunction or failure of a TOSHIBA product could cause loss of human life, bodily injury or damage to property. In developing your designs, please ensure that TOSHIBA products are used within specified operating ranges as set forth in the most recent products specifications. Also, please keep in mind the precautions and conditions set forth in the TOSHIBA Semiconductor Reliability Handbook.
- The products described in this document are subject to foreign exchange and foreign trade control laws.
- The information contained herein is presented only as a guide for the applications of our products. No responsibility is assumed by TOSHIBA CORPORATION for any infringements of intellectual property or other rights of the third parties which may result from its use. No license is granted by implication or otherwise under any intellectual property or other rights of TOSHIBA CORPORATION or others.
- The information contained herein is subject to change without notice.

BLOCK DIAGRAM

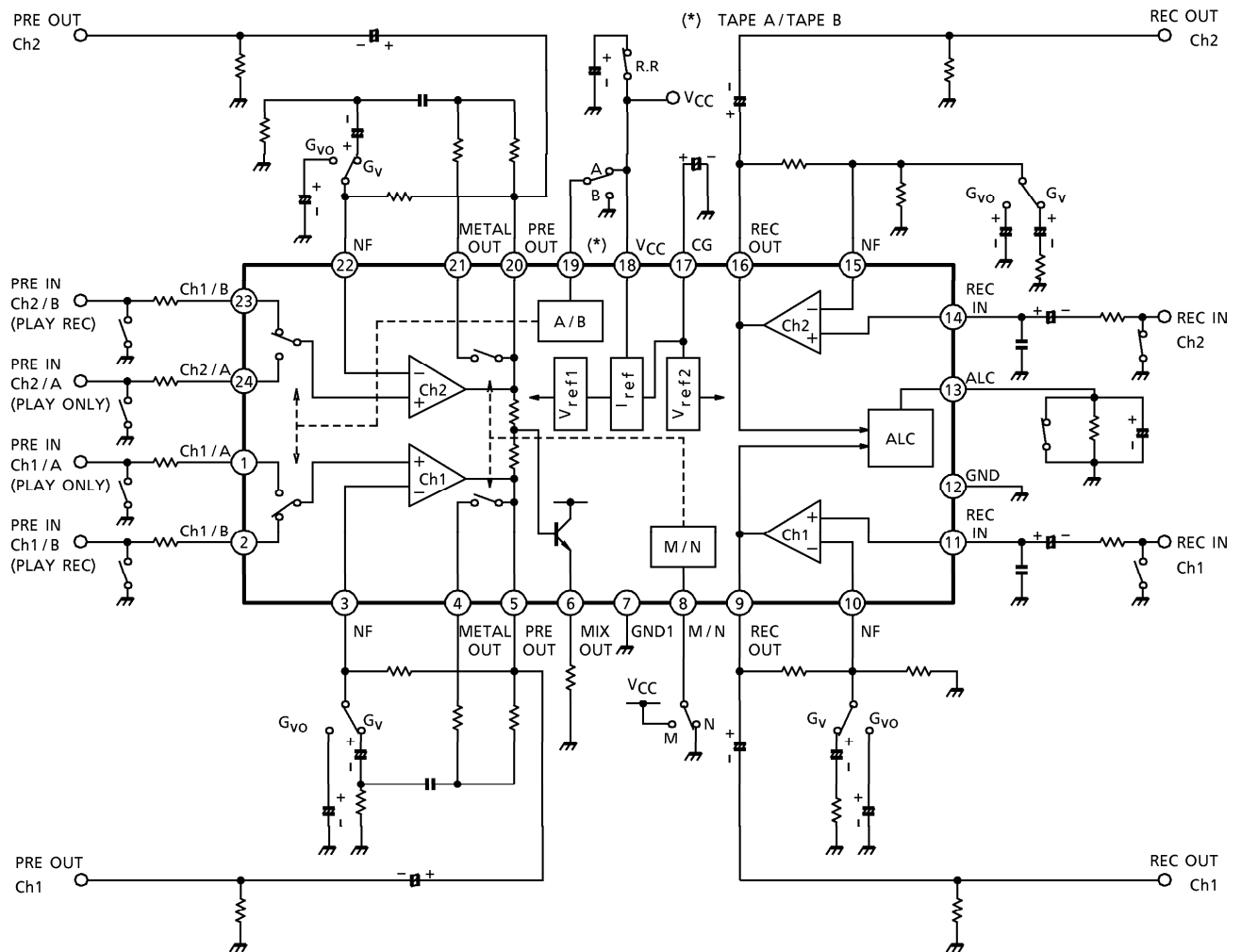

TERMINAL EXPLANATION

TERMINAL No.	SYMBOL	FUNCTION	EQUIVALENT CIRCUIT
1	TAPE A IN (Ch1)	Tape play back input (PLAY)	
24	TAPE A IN (Ch1)		
2	TAPE B IN (Ch2)	Tape play back input (PLAY / REC)	
23	TAPE B IN (Ch2)		
3	PB NF (Ch1)	Tape play back NF	
22	PB NF (Ch2)		
4 / 21	METAL OUT	Metal EQ Switch	
5	PRE OUT (Ch1)	Play back Amp output	
20	PRE OUT (Ch2)		
6	MIX OUT	Mixing output	
7	GND	GND	—
8	METAL / NORMAL SW	Change over switch for metal mode and normal mode.	

TERMINAL No.	SYMBOL	FUNCTION	EQUIVALENT CIRCUIT
9	REC OUT (Ch1)	Recording Amp output	
16	REC OUT (Ch2)		
10	REC NF (Ch1)	Recording Amp NF	
15	REC NF (Ch2)		
11	REC IN (Ch1)	Recording Amp input	
14	REC IN (Ch2)		
12	GND	GND	—
13	ALC T.C	Automatic level Control (ALC) time constant terminal	
17	CG Det.	NF charge up circuit switching terminal	

TERMINAL No.	SYMBOL	FUNCTION	EQUIVALENT CIRCUIT
19	TAPE A / TAPE B SW	Play back AMP input selector	

APPLICATION INFORMATION AND APPLICATION METHOD

1. Input level of play amp.

In case that input voltage ($V_{in} > 0.0245V_{rms}$ (-30dBm)) is applied to A-Head and B-Head at same time on a set, use A-Head for reproducing only and, B-Head for recording or reproducing.

In case that the over-voltage is applied to A-Head and B-Head at same time, the Transistor Q₃, Q₄ are made a saturation condition and NF condenser is discharged by Base-current of Q₃, Q₄ and the output DC voltage of pin 3 / 22 are raised.

In case of the high input, use B-Head, because of building in the diode against saturation on Q₄.

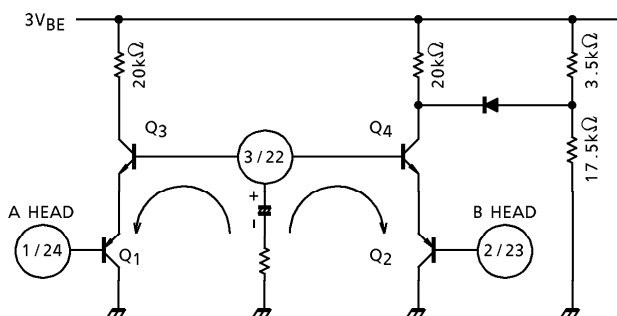

2. Power source line

In case of including the Ripple on the power source line, stabilize by using a transistor as following figure.

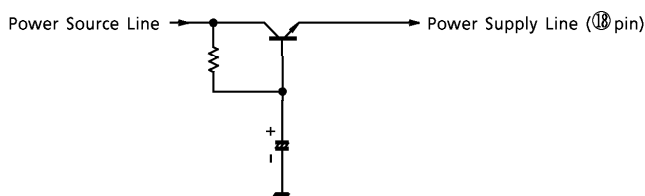

MAXIMUM RATINGS (Ta = 25°C)

CHARACTERISTIC	SYMBOL	RATING	UNIT
Supply Voltage	V _{CC}	14.5	V
Power Dissipation	P _D (Note)	1200	mW
Operating Temperature	T _{opr}	- 20~75	°C
Storage Temperature	T _{stg}	- 55~150	°C

(Note) Derated above Ta = 25°C in the proportion of 9.6mW/°C.

ELECTRICAL CHARACTERISTICS (Unless otherwise specified, V_{CC} = 6V, f = 1kHz, Ta = 25°C)

CHARACTERISTIC	SYMBOL	TEST CIRCUIT	TEST CONDITION	MIN.	TYP.	MAX.	UNIT
Quiescent Current	I _{CCQ}	—	METAL MODE, V _{in} = 0	—	13	20	mA
Play Back Amp.	Output Noise Voltage	V _{no}	NORMAL MODE, R _g = 2.2kΩ, NAB EQ, BW = 20Hz~20kHz, G _V = 40dB	—	200	600	μV _{rms}
	Total Harmonic Distortion	THD	V _{out} = 0.2V _{rms} , f = 1kHz Normal mode	—	0.06	0.2	%
	Maximum Output Voltage	V _{om}	THD = 1.0%, R _L = 10kΩ, f = 1kHz, NORMAL MODE	0.5	1.0	—	V _{rms}
	Open Loop Voltage Gain	G _{vo}	f = 1kHz, R _L = 10kΩ, V _{in} = 13.8μV (-95dBm)	70	95	—	dB
	Cross Talk	C.T. (Ch)	V _{out} = 0.775V _{rms} (0dBm), f = 1kHz, R _g = 2.2kΩ, NORMAL MODE	- 40	- 60	—	dB
	TAPE A / TAPE B Cross Talk	C.T. (IN)	V _{out} = 0.775V _{rms} (0dBm), f = 1kHz, R _g = 2.2kΩ, NORMAL MODE	—	- 66	—	dB
	Ripple Rejection Ratio	R.R.	V _{ripple} = 0.775V _{rms} (0dBm), f _{ripple} = 100Hz, R _g = 2.2kΩ, NORMAL MODE	—	- 38	—	dB
Voltage Gain	G _{vn}	V _{in} = 7.75mV _{rms} (-40dBm), f = 1kHz, R _L = 10kΩ, NORMAL NAB	—	40	—	dB	
Pre Amp → Rec Amp C.T.	C.T. (P / R)	—	f = 1kHz, V _{out} (PRE) = 0.775V _{rms} (0dBm), NORMAL (PRE)	—	- 53	—	dB
Rec Amp → Pre Amp C.T.	C.T. (R / P)	—	f = 1kHz, V _{out} (REC) = 0.775V _{rms} (0dBm), NORMAL (PRE)	—	- 76	—	dB

CHARACTERISTIC	SYMBOL	TEST CIR-CUIT	TEST CONDITION	MIN.	TYP.	MAX.	UNIT	
Recording Amp.	Output Noise Voltage	V_{no}	—	$R_g = 2.2k\Omega$, $BW = 20Hz \sim 20kHz$, ALC OFF $G_v = 60dB$	—	1.35	2.7	mV
	Total Harmonic Distortion	THD	—	$V_{out} = 0.5V_{rms}$, $f = 1kHz$, ALC OFF $R_L = 10k\Omega$	—	0.37	1.0	%
	Maximum Output Voltage	V_{om}	—	THD = 1%, $R_L = 10k\Omega$, $f = 1kHz$, ALC OFF	1.2	1.5	—	V_{rms}
	Open Loop Voltage Gain	G_{vo}	—	$f = 1kHz$, $R_L = 10k\Omega$, ALC OFF, $V_{in} = 3.16\mu V_{rms}$ (- 110dBV)	80	108	—	dB
	ALC Range	R (ALC)	—	3dB up, $f = 1kHz$, dual input	—	52	—	dB
	Total Harmonic Distortion (ALC)	THD (ALC)	—	$V_{in} = 0.0775V_{rms}$ (- 20dBm), $f = 1kHz$ dual input, $R_L = 10k\Omega$	—	0.48	1.0	%
	ALC Balance	B (ALC)	—	$V_{in} = 0.0775V_{rms}$ (- 20dBm), dual input, $R_L = 10k\Omega$, $f = 1kHz$	—	0	2	dB
	ALC Level	V (ALC)	—	$V_{in} = 0.0775V_{rms}$ (- 20dBm), $f = 1kHz$, $R_L = 10k\Omega$	0.75	1.0	1.2	V_{rms}
	Ripple Rejection Ratio	R.R.	—	$V_{ripple} = 0.775V_{rms}$ (0dBm), $f = 100Hz$, $R_g = 2.2k\Omega$	—	- 30	—	dB
	Voltage Gain	G_{vn}	—	$f = 1kHz$ (FLAT), $R_L = 10k\Omega$, $V_{in} = 1mV_{rms}$ (- 60dBV)	—	61	—	dB
	Cross Talk (ALC OFF)	C.T. (Ch)	—	$V_{out} = 0.775V_{rms}$ (0dBm), $f = 1kHz$, $R_g = 2.2k\Omega$ ALC OFF, $V_{in} = 1mV_{rms}$ (- 60dBV)	- 40	- 54	—	dB
	Cross Talk (ALC ON)	C.T. (ALC)	—	$V_{out} = 0.775V_{rms}$ (0dBm), $f = 1kHz$, $R_g = 2.2k\Omega$, ALC ON, $V_{in} = 0.0775V_{rms}$ (- 20dBm)	- 40	- 54	—	dB

TEST CIRCUIT

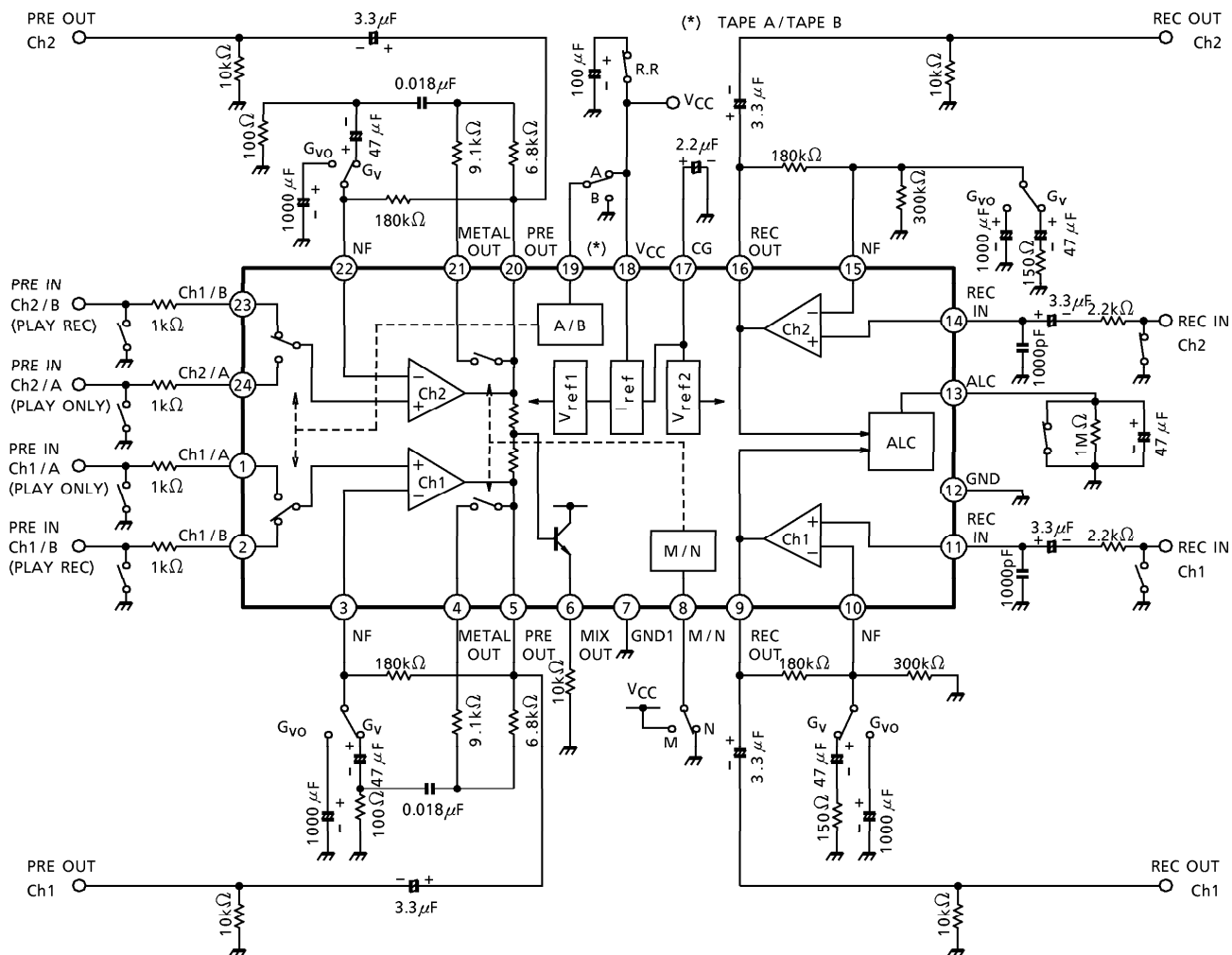

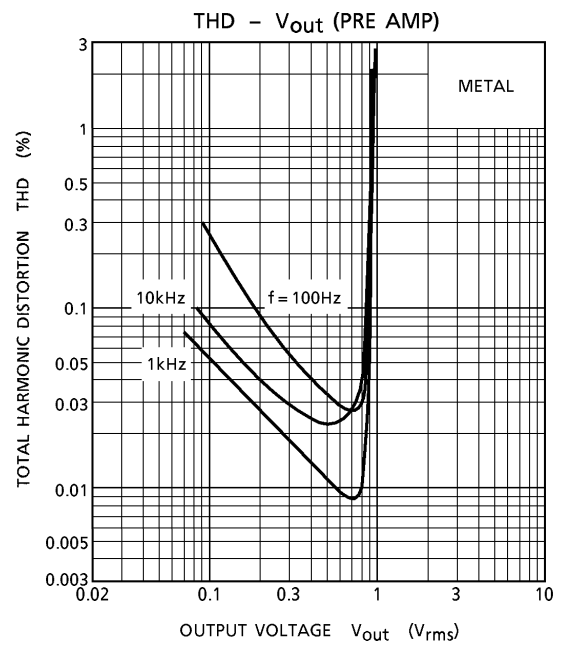
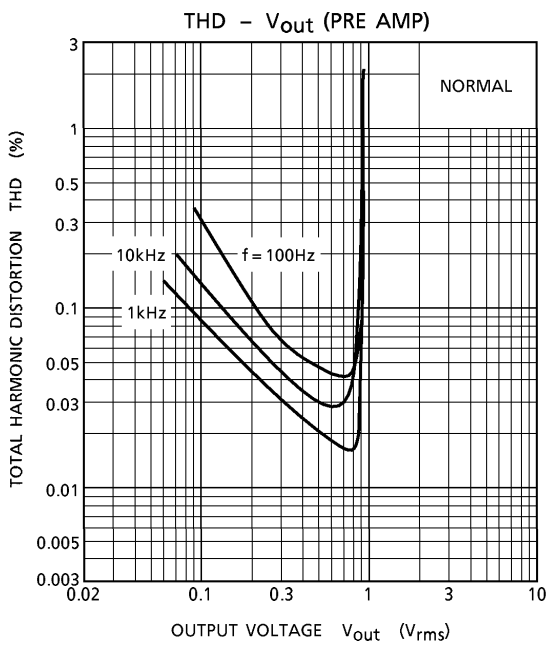
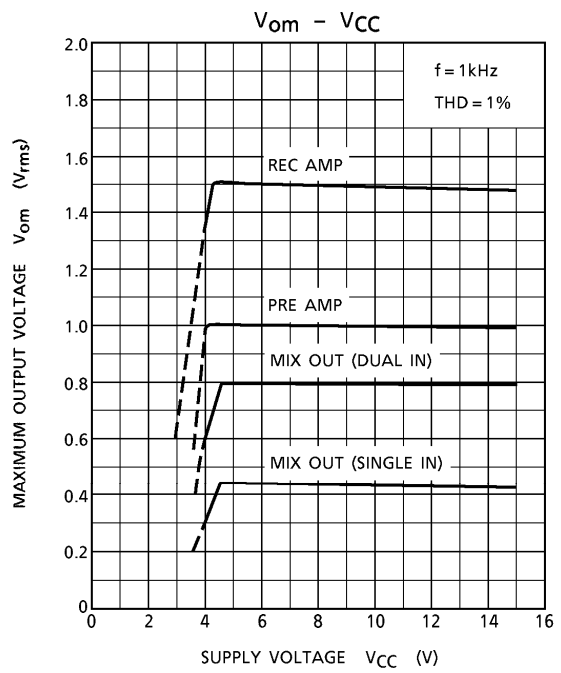
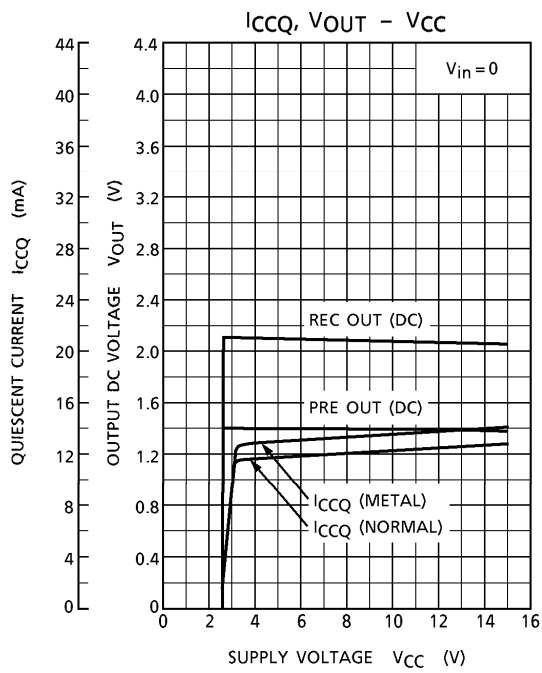

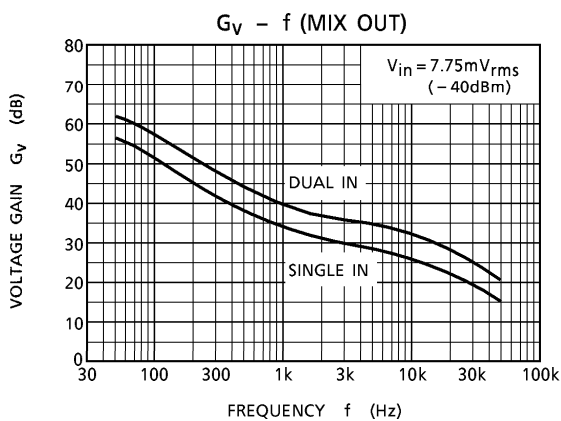
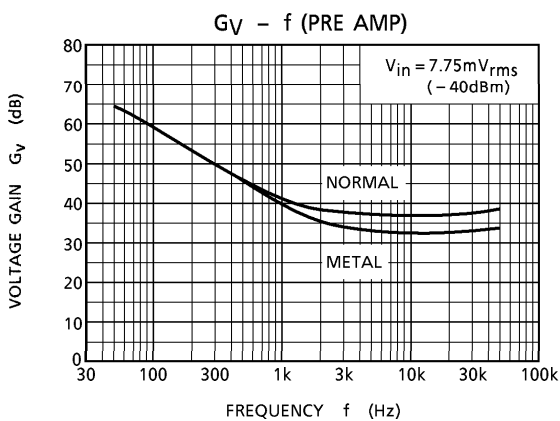
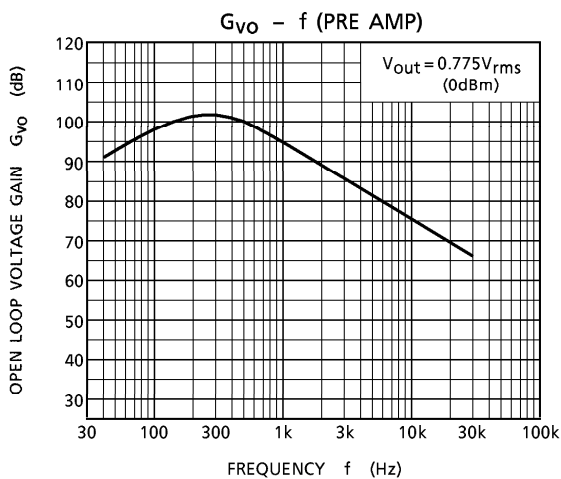
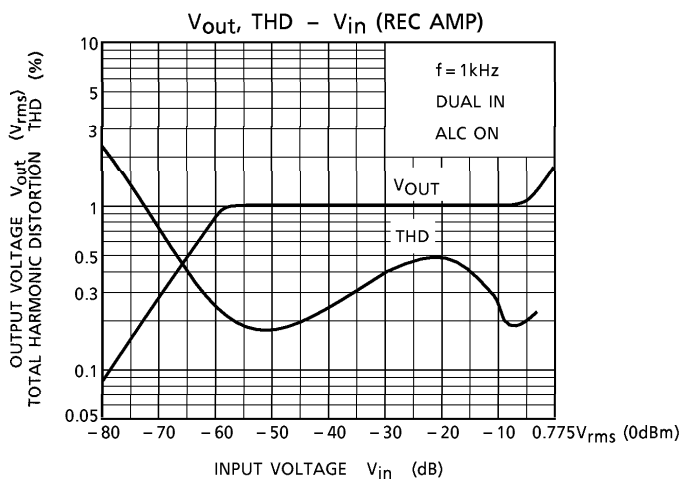
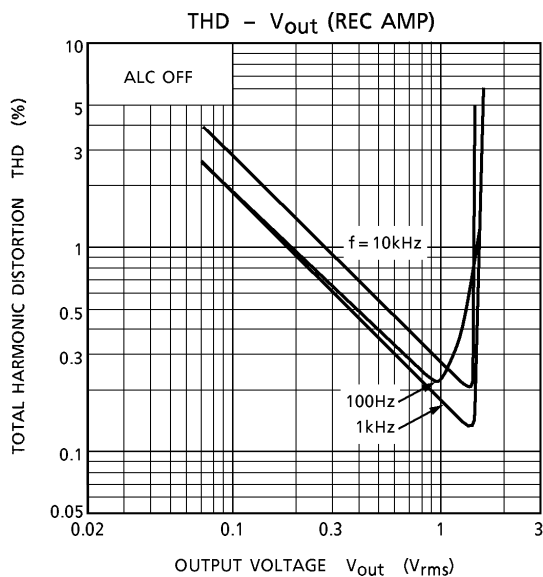
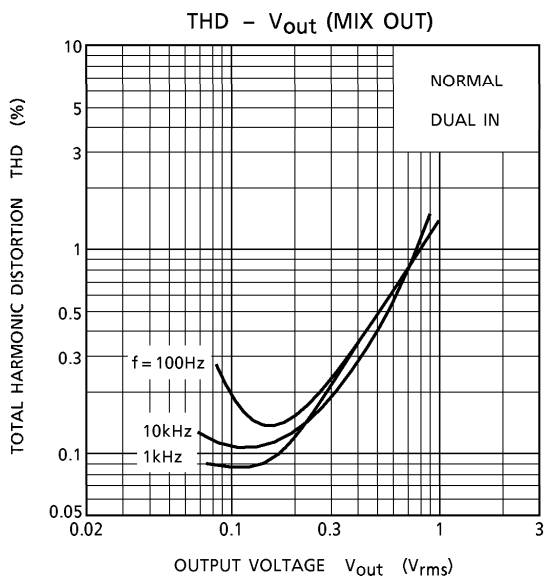

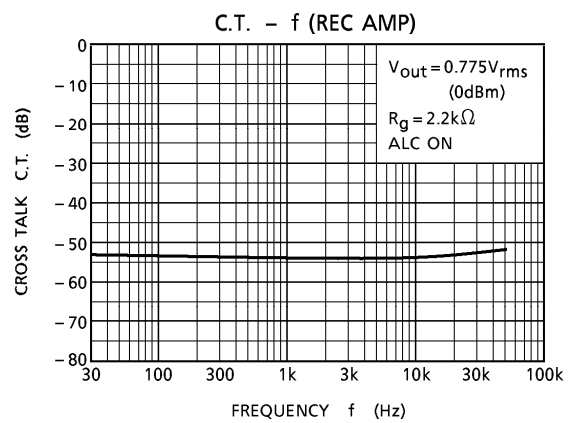
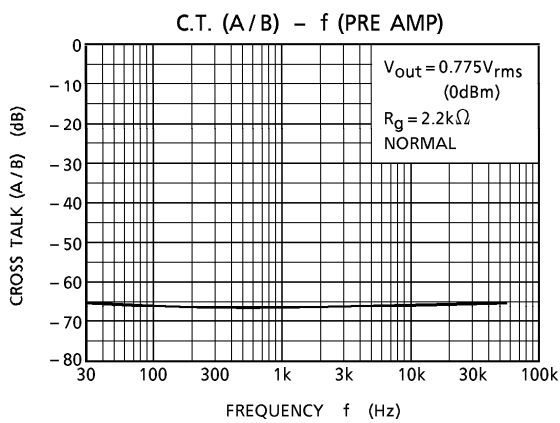
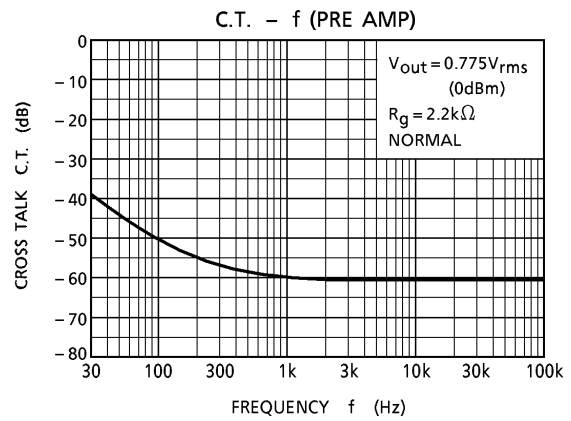
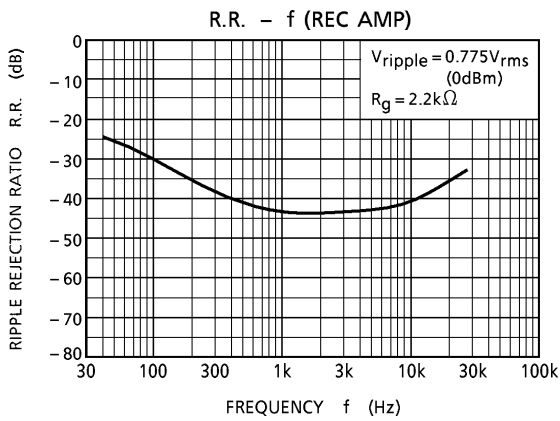
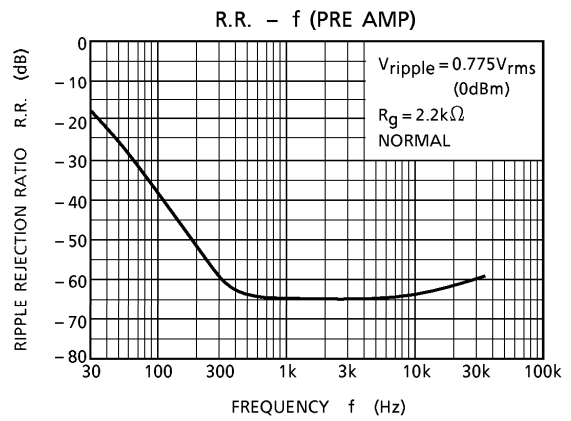
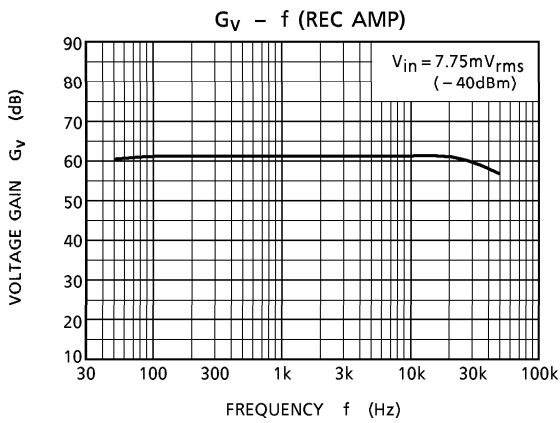

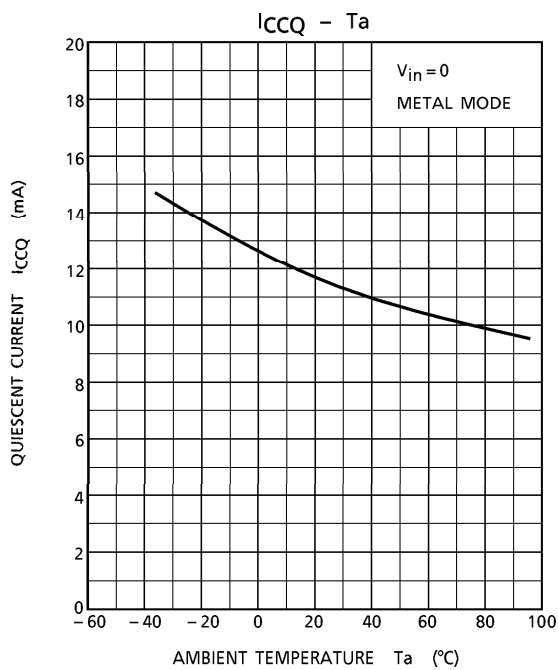
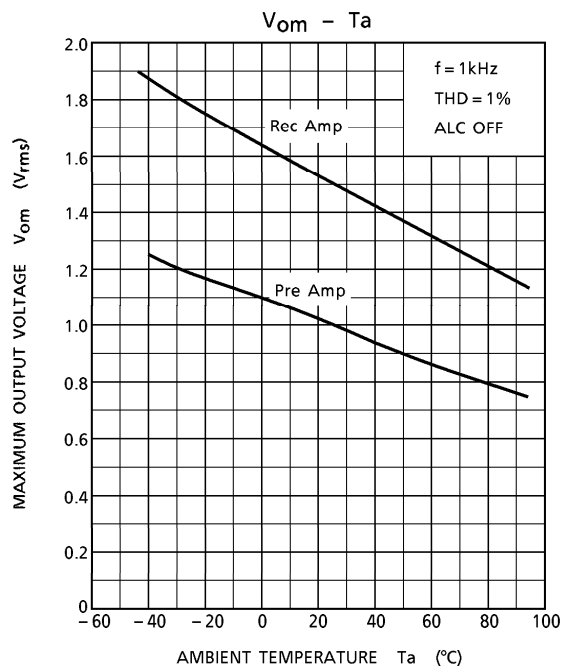
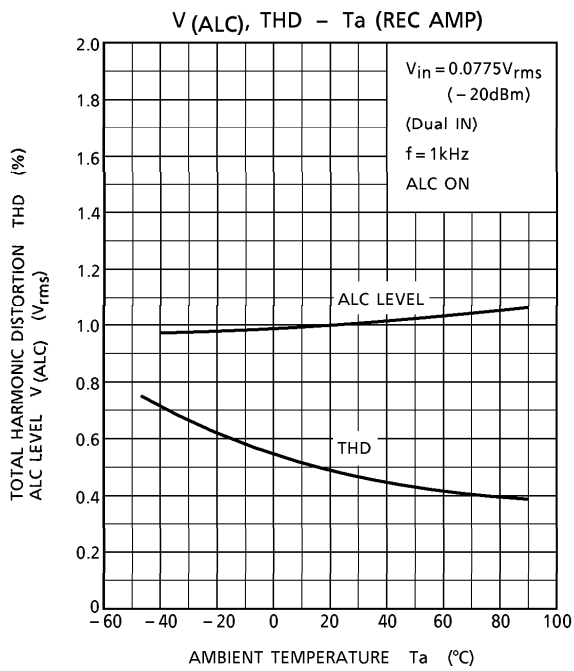

APPLICATION CIRCUIT

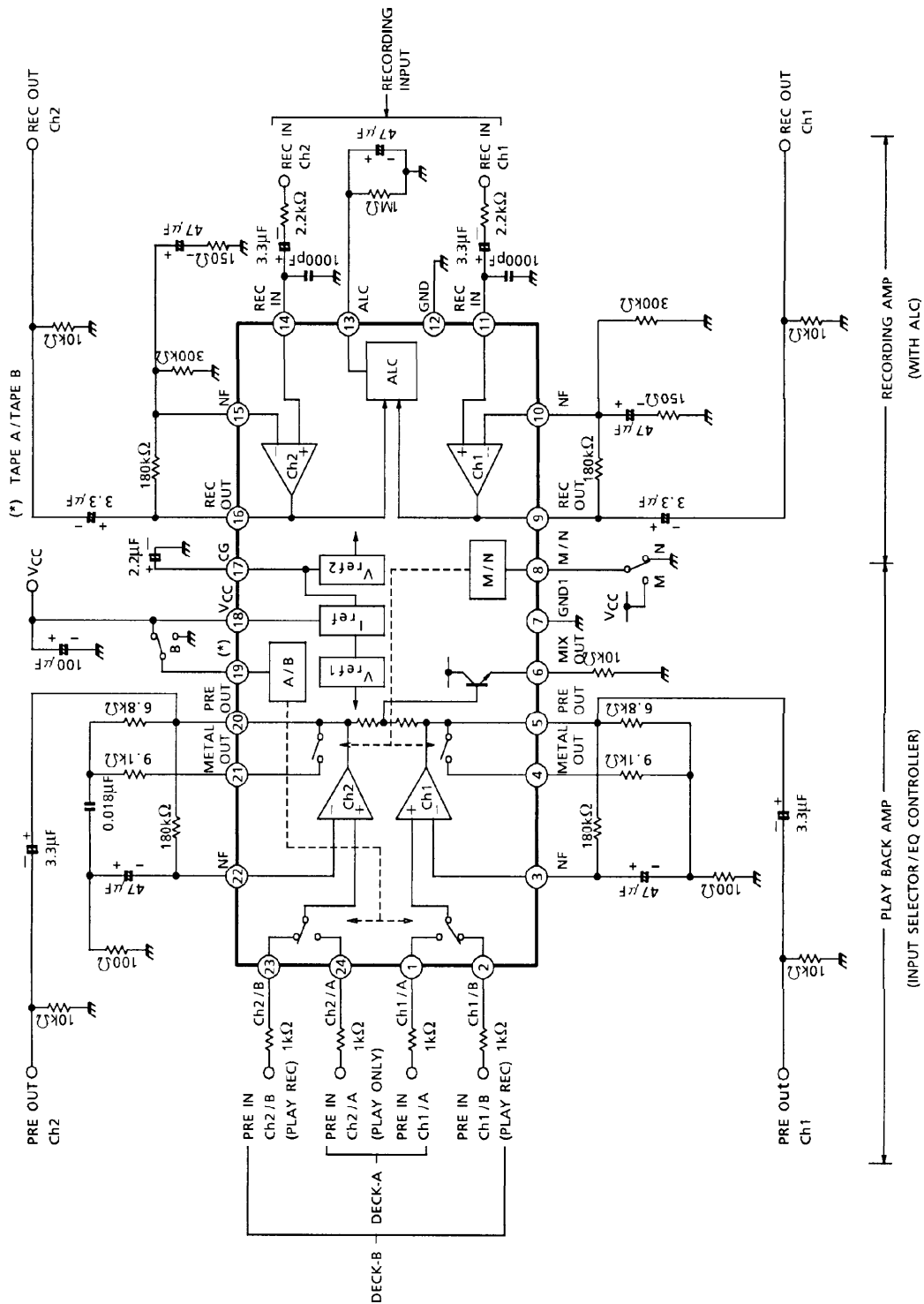

TA8189N-13(B4)

OUTLINE DRAWING
SDIP24-P-300-1.78

Unit : mm

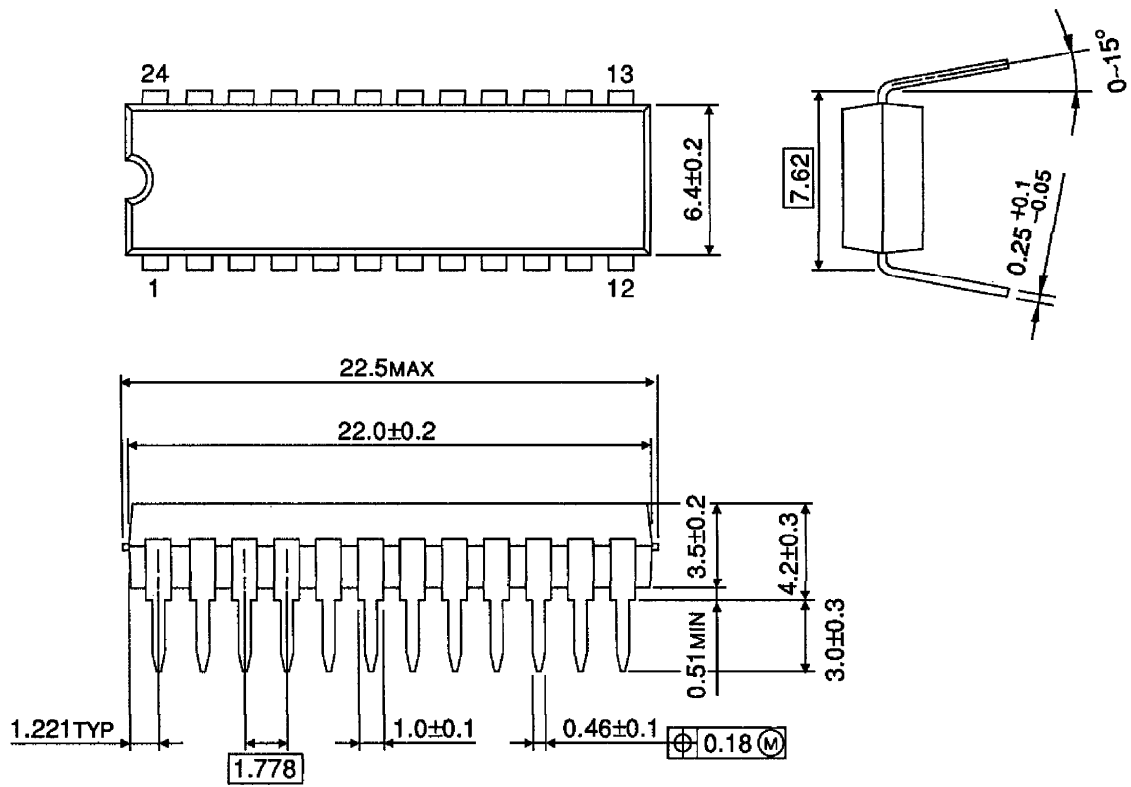

Weight : 1.2g (Typ.)