

High Frequency 200mA Charge Pump Inverter or Doubler

- Inverts or Doubles Input Supply Voltage
- 92% Power Efficiency at 100mA
- 120kHz/900kHz Selectable Oscillator Frequency
- 4.5Ω Output Resistance Using 3.3μF Ceramic Caps
- Low Voltage Battery Operation
- Ideal for 3.6V Lithium Ion Battery or 5.0V Input
- High Output Current – 200mA
- Low Profile Solution
- 1.5V Inverter Startup Guaranteed
- Pin-Compatible High-Current Upgrade of the ICL7660 and 660 Industry Standard
- Smallest Package Available for the 660 Industry Standard – 8 pin μSOIC



Now Available in Lead Free Packaging

DESCRIPTION

The **SP6661** is a CMOS DC-DC Monolithic Voltage Converter that can be implemented as a Voltage Inverter or a Positive Voltage Doubler. As a Voltage Inverter, a -1.5V to -5.0V output can be converted from a +1.5V to +5.0V input. As a Voltage Doubler, a +5.0V to +10.0V output can be provided from a +2.5V to +5.0V input. The **SP6661** is ideal for both battery-powered and board level voltage conversion applications with a typical operating current of 3mA and a high efficiency (>90%) over most of its load-current range. Typical end products for this device are disk drive supplies, operational amplifier and interface power supplies, medical instruments, and hand held and laptop computers. The **SP6661** is available in 8-pin NSOIC, and μSOIC packages.

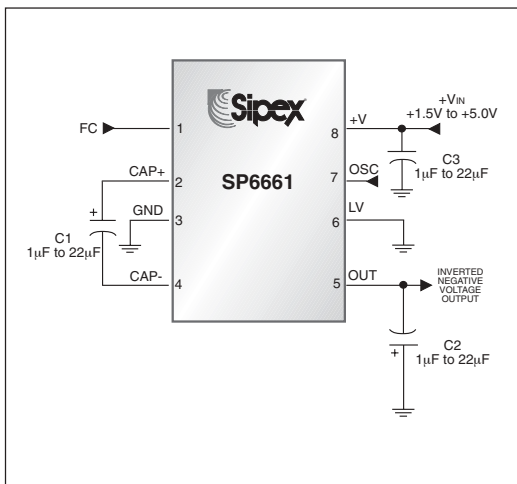

Figure 1: Voltage Inverter

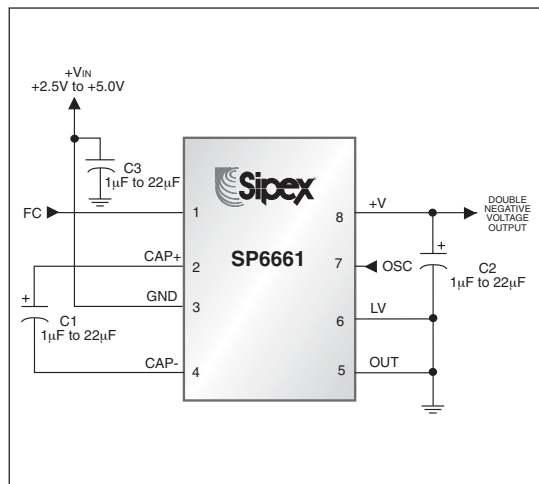

Figure 2: Voltage Doubler

ABSOLUTE MAXIMUM RATINGS

These are stress ratings only and functional operation of the device at these ratings or any other above those indicated in the operation sections of the specifications below is not implied. Exposure to absolute maximum rating conditions for extended periods of time may affect reliability.

Power Supply Voltage
(V+ to GND or GND to OUT).....+5.6V
LV Input Voltages.....(OUT - 0.3V) to (V+ + 0.3V)
FC and OSC Input Voltages.....The least negative of
(OUT - 0.3V) or (V+ - 5.6V) to (V+ + 0.3V)

OUT and V+ Continuous Output Current.....200mA
Output Short-Circuit Duration to GND (Note 1).....1s
Operating Temperature Ranges
SP6661E.....-40°C to +85°C
Continuous Power Dissipation ($T_{AMB} = 70^{\circ}\text{C}$)
NSOIC (derate 5.88mW/°C above +70°C).....471mW
 μ SOIC (derate 4.10mW/°C above +70°C).....330mW
Operating Temperature.....-40°C to +85°C
Storage Temperature.....-65°C to +150°C
Lead Temperature (soldering 10s).....+300°C

SPECIFICATIONS

| PARAMETER | MIN. | TYP. | MAX. | UNITS | CONDITIONS |
|--|----------|----------|------|----------|--|
| Inverter Circuit at Low Frequency with 22μF Capacitors | | | | | |
| V+ = +5.0V, C1 = C2 = C3 = 22 μ F, FC = open, LV = GND, $T_{AMB} = T_{MIN}$ to T_{MAX} ; refer to <i>Figure 1</i> test circuit. Note 2 | | | | | |
| Supply Voltage Range | 1.5 | | 5.3 | V | $R_L = 500\Omega$ |
| Start-Up Voltage | | 0.93 | | V | |
| Supply Current | | 3 | 6 | mA | No Load |
| Max Output Current | 200 | | | mA | |
| Oscillator Input Current | | ± 1 | | μ A | |
| Oscillator Frequency | 70 | 120 | 170 | kHz | |
| Output Resistance | | 5 | 7 | Ω | $I_L = 100\text{mA}$, Note 3 |
| Voltage Conversion Efficiency | 99.0 | 99.9 | | % | No Load |
| Power Efficiency | 80 70 | 89 82 | | % | $I_L = 100\text{mA}$ $I_L = 200\text{mA}$ |
| Doubler Circuit at Low Frequency with 22μF Capacitors | | | | | |
| V+ = +5.0V, C1 = C2 = C3 = 22 μ F, FC = open, LV = GND, $T_{AMB} = T_{MIN}$ to T_{MAX} ; refer to <i>Figure 22</i> test circuit. Note 2 | | | | | |
| Supply Voltage Range | 2.5 | | 5.3 | V | $R_L = 1\text{k}\Omega$ |
| Start-Up Voltage | | 1.5 | | V | |
| Supply Current | | 3 | 6 | mA | No Load |
| Max Output Current | 200 | | | mA | |
| Oscillator Input Current | | ± 1 | | μ A | |
| Oscillator Frequency | 70 | 120 | 170 | kHz | |
| Output Resistance | | 4.5 | 7 | Ω | $I_L = 100\text{mA}$, Note 3 |
| Voltage Conversion Efficiency | 99.0 | 99.9 | | % | No Load |
| Power Efficiency | 89 79 | 94 90 | | % | $I_L = 100\text{mA}$ $I_L = 200\text{mA}$ |

SPECIFICATIONS (continued)

| PARAMETER | MIN. | TYP. | MAX. | UNITS | CONDITIONS |
|---|----------|----------|------|----------|--|
| Inverter Circuit at High Frequency with 3.3μF Capacitors | | | | | |
| V ₊ = +5.0V, C ₁ = C ₂ = C ₃ = 3.3 μ F, FC = V ₊ , LV = GND, T _{AMB} = T _{MIN} to T _{MAX} ; refer to <i>Figure 1</i> test circuit. Note 2 | | | | | |
| Supply Voltage Range | 1.5 | | 5.3 | V | R _L = 500 Ω |
| Start-Up Voltage | | 0.93 | | V | |
| Supply Current | | 10 | 18 | mA | No Load |
| Max Output Current | 200 | | | mA | |
| Oscillator Input Current | | ± 8 | | μ A | |
| Oscillator Frequency | 500 | 900 | 1250 | kHz | |
| Output Resistance | | 5 | 7 | Ω | I _L = 100mA, Note 3 |
| Voltage Conversion Efficiency | 99.0 | 99.6 | | % | No Load |
| Power Efficiency | 78 65 | 84 79 | | % | I _L = 100mA I _L = 200mA |
| Doubler Circuit at High Frequency with 3.3μF Capacitors | | | | | |
| V ₊ = +5.0V, C ₁ = C ₂ = C ₃ = 3.3 μ F, FC = V ₊ , LV = GND, T _{AMB} = T _{MIN} to T _{MAX} ; refer to <i>Figure 2</i> test circuit. Note 2 | | | | | |
| Supply Voltage Range | 2.5 | | 5.3 | V | R _L = 1k Ω |
| Start-Up Voltage | | 1.5 | | V | |
| Supply Current | | 10 | 18 | mA | No Load |
| Max Output Current | 200 | | | mA | |
| Oscillator Input Current | | ± 8 | | μ A | |
| Oscillator Frequency | 500 | 900 | 1250 | kHz | |
| Output Resistance | | 4.5 | 7 | Ω | I _L = 100mA, Note 3 |
| Voltage Conversion Efficiency | 99.0 | 99.9 | | % | No Load |
| Power Efficiency | 87 79 | 92 89 | | % | I _L = 100mA I _L = 200mA |

NOTE 1: Specified output resistance is a combination of internal switch resistance and capacitor ESR.

NOTE 2: In the test circuit capacitors C₁, C₂ and C₃ are 22 μ F, 0.05 maximum ESR, ceramic or 3.3 μ F, 0.05 Ω maximum ESR, ceramic. Capacitors with higher ESR may reduce output voltage and efficiency. Refer to Capacitor Selection section.

NOTE 3: Specified output resistance is a combination of internal switch resistance and capacitor ESR. Refer to Optimizing Capacitor Selection.

Optimizing Capacitor Selection

Refer to *Figure 1* for the total output resistance for various capacitance values and oscillator frequencies. The reservoir and charge pump capacitor values are equal. The capacitance values required to maintain comparable ripple and output resistance typically diminish proportionately as the pump frequency of the **SP6661** increases.

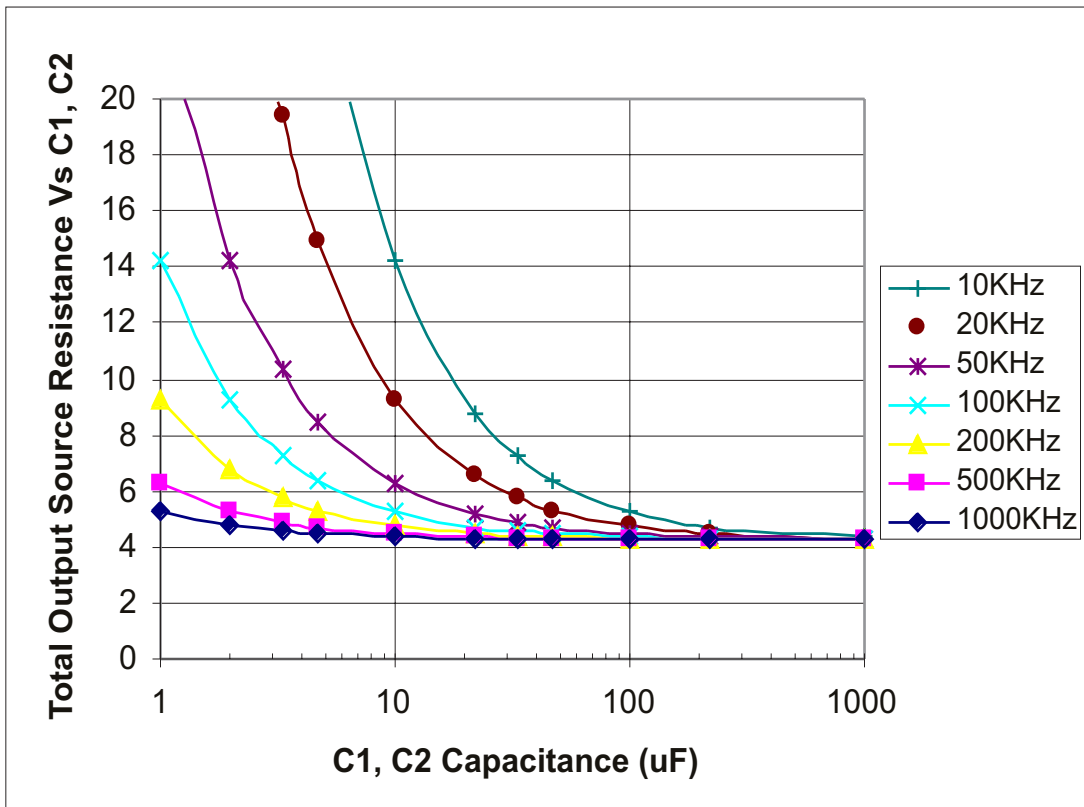
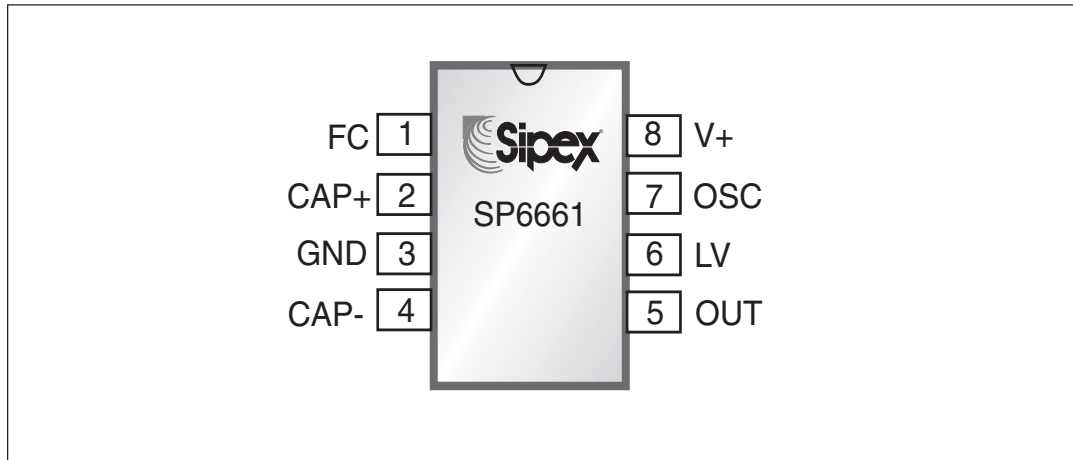

Figure 1. Total Output Resistance for various capacitance values and oscillator frequencies.

PINOUT



PIN ASSIGNMENTS

| Pin Number | Pin Symbol | Description |
|------------|------------|--|
| 1 | FC | Frequency Control for the internal oscillator. FC = open, $f_{osc} = 120\text{kHz}$ typical; FC = V+ $f_{osc} = 900\text{kHz}$ typical. |
| 2 | CAP+ | Connect to the positive terminal of the charge pump capacitor. |
| 3 | GND | (Voltage Inverter Circuit) Ground. |
| 3 | GND | (Positive Voltage Doubler Circuit) Positive supply voltage input. |
| 4 | CAP- | Connect to the negative terminal of the charge pump capacitor. |
| 5 | OUT | (Voltage Inverter Circuit) Negative voltage output pin. |
| 5 | OUT | (Positive Voltage Doubler Circuit) Ground pin for power supply. |
| 6 | LV | Low -voltage operation input pin in 660 circuits. In SP6661 circuits can be connected to GND, OUT or left open as desired with no effect. |
| 7 | OSC | Control pin for the oscillator. Internally connected to 15pF capacitor. An external capacitor can be added to slow the oscillator. Be careful to minimize stray capacitance. An external oscillator can be connected to overdrive the OSC pin. |
| 8 | V+ | (Voltage Inverter Circuit) Positive voltage input pin for the power supply. |
| 8 | V+ | (Positive Voltage Doubler Circuit) Positive voltage output. |

All package dimensions in inches

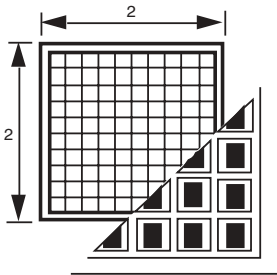
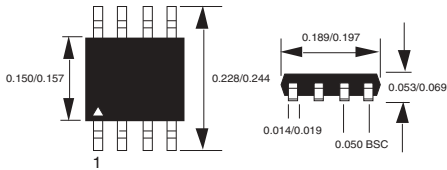

100 die per waffle pack



95 NSOIC devices per tube, no minimum quantity

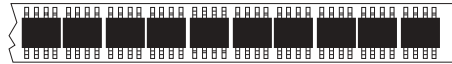
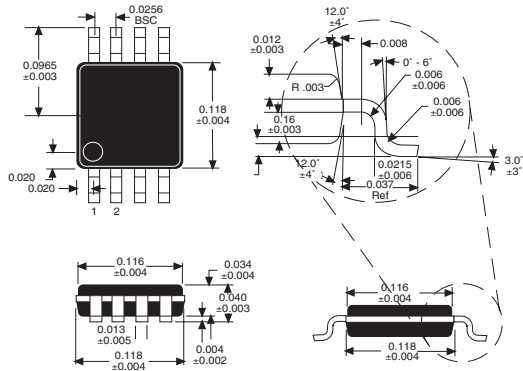

50 μSOIC devices per tube

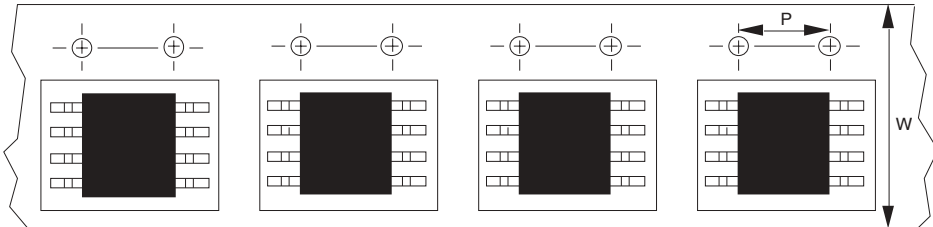

8-pin NSOIC 13" reels: P = 8mm, W = 12mm

| pkg | min qty per reel | std qty per reel | max qty per reel |
|-----|------------------|------------------|------------------|
| CN | 500 | 1500 | 2500 |
| CU | 500 | 1500 | 3000 |

ORDERING INFORMATION

| Part Number | Temperature Range | Package Type |
|-----------------------|--------------------------|-----------------------------------|
| SP6661EN | -40°C to +85°C | 8-Pin NSOIC |
| SP6661EN/TR | -40°C to +85°C | 8-Pin NSOIC |
| SP6661EU | -40°C to +85°C | 8-Pin μ SOIC |
| SP6661EU/TR | -40°C to +85°C | 8-Pin μ SOIC |
| SP6661UEB | | 8-Pin μ SOIC Evaluation Board |

Available in lead free packaging. To order add "-L" suffix to part number.

Example: SP6661EN/TR = standard; SP6661EN-L/TR = lead free

/TR = Tape and Reel

Pack quantity is 2500 for NSOIC.



ANALOG EXCELLENCE

Sipex Corporation

Headquarters:

233 Hillview Dr.
Milpitas, CA 95035
TEL: (408) 934-7500
FAX: (408) 935-7600

Sipex Corporation reserves the right to make changes to any products described herein. Sipex does not assume any liability arising out of the application or use of any product or circuit described herein; neither does it convey any license under its patent rights nor the rights of others.