

# Cascadable Silicon Bipolar MMIC Amplifiers

## Technical Data

### MSA-0435, -0436

#### Features

- **Cascadable 50 Ω Gain Block**
- **3 dB Bandwidth:**  
DC to 3.8 GHz
- **12.5 dBm Typical P<sub>1 dB</sub> at  
1.0 GHz**
- **8.5 dB Typical Gain at  
1.0 GHz**
- **Unconditionally Stable  
(k > 1)**
- **Cost Effective Ceramic  
Microstrip Package**

#### Description

The MSA-0435 is a high performance silicon bipolar Monolithic Microwave Integrated Circuit (MMIC) housed in a cost effective, microstrip package. This MMIC is

designed for use as a general purpose 50 Ω gain block. Typical applications include narrow and broad band IF and RF amplifiers in industrial and military applications.

The MSA-series is fabricated using HP's 10 GHz  $f_T$ , 25 GHz  $f_{MAX}$ , silicon bipolar MMIC process which uses nitride self-alignment, ion implantation, and gold metallization to achieve excellent performance, uniformity and reliability. The use of an external bias resistor for temperature and current stability also allows bias flexibility.

Available in cut lead version (package 36) as MSA-0436.

#### 35 micro-X Package<sup>[1]</sup>

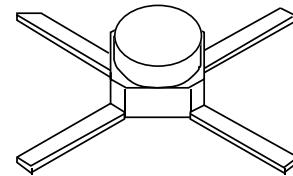

#### Note:

1. Short leaved 36 package available upon request.

#### Typical Biasing Configuration

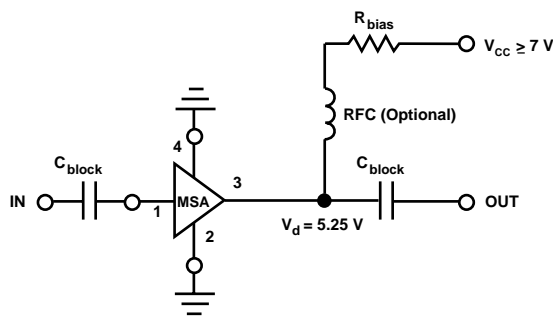

## MSA-0435, -0436 Absolute Maximum Ratings

Parameter	Absolute Maximum <sup>[1]</sup>
Device Current	100 mA
Power Dissipation <sup>[2,3]</sup>	650 mW
RF Input Power	+13 dBm
Junction Temperature	200°C
Storage Temperature <sup>[4]</sup>	-65 to 200°C

**Thermal Resistance<sup>[2,5]</sup>:**

$$\theta_{jc} = 140^{\circ}\text{C}/\text{W}$$

### Notes:

1. Permanent damage may occur if any of these limits are exceeded.
2.  $T_{\text{CASE}} = 25^{\circ}\text{C}$ .
3. Derate at  $7.1 \text{ mW}/^{\circ}\text{C}$  for  $T_{\text{C}} > 109^{\circ}\text{C}$ .
4. Storage above  $+150^{\circ}\text{C}$  may tarnish the leads of this package making it difficult to solder into a circuit.
5. The small spot size of this technique results in a higher, though more accurate determination of  $q_{jc}$  than do alternate methods. See MEASUREMENTS section "Thermal Resistance" for more information.

## Electrical Specifications<sup>[1]</sup>, $T_{\text{A}} = 25^{\circ}\text{C}$

Symbol	Parameters and Test Conditions: $I_{\text{d}} = 50 \text{ mA}$ , $Z_{\text{o}} = 50 \Omega$	Units	Min.	Typ.	Max.
$G_{\text{P}}$	Power Gain ( $ S_{21} ^2$ ) $f = 0.1 \text{ GHz}$	dB	7.5	8.5	9.5
$\Delta G_{\text{P}}$	Gain Flatness $f = 0.1 \text{ to } 2.5 \text{ GHz}$	dB		$\pm 0.6$	$\pm 1.0$
$f_{3 \text{ dB}}$	3 dB Bandwidth	GHz		3.8	
VSWR	Input VSWR $f = 0.1 \text{ to } 2.5 \text{ GHz}$			1.4:1	
	Output VSWR $f = 0.1 \text{ to } 2.5 \text{ GHz}$			1.9:1	
NF	50 $\Omega$ Noise Figure $f = 1.0 \text{ GHz}$	dB		6.5	
$P_{1 \text{ dB}}$	Output Power at 1 dB Gain Compression $f = 1.0 \text{ GHz}$	dBm		12.5	
$\text{IP}_3$	Third Order Intercept Point $f = 1.0 \text{ GHz}$	dBm		25.5	
$t_{\text{D}}$	Group Delay $f = 1.0 \text{ GHz}$	psec		125	
$V_{\text{d}}$	Device Voltage	V	4.75	5.25	5.75
$dV/dT$	Device Voltage Temperature Coefficient	mV/ $^{\circ}\text{C}$		-8.0	

### Note:

1. The recommended operating current range for this device is 30 to 70 mA. Typical performance as a function of current is on the following page.

## Part Number Ordering Information

Part Number	No. of Devices	Container
MSA-0435	10	Strip
MSA-0436-BLK	100	Antistatic Bag
MSA-0436-TR1	1000	7" Reel

For more information, see "Tape and Reel Packaging for Semiconductor Devices".

**MSA-0435, -0436 Typical Scattering Parameters ( $Z_0 = 50 \Omega$ ,  $T_A = 25^\circ\text{C}$ ,  $I_d = 50 \text{ mA}$ )**

Freq. GHz	$S_{11}$		$S_{21}$			$S_{12}$			$S_{22}$	
	Mag	Ang	dB	Mag	Ang	dB	Mag	Ang	Mag	Ang
0.1	.08	175	8.5	2.67	175	-16.4	.151	1	.20	-10
0.2	.08	172	8.5	2.68	170	-16.3	.153	2	.20	-16
0.4	.07	171	8.5	2.67	161	-16.4	.151	3	.20	-33
0.6	.07	166	8.5	2.66	151	-16.2	.155	6	.21	-45
0.8	.05	169	8.4	2.64	142	-16.1	.156	8	.22	-57
1.0	.05	175	8.3	2.61	136	-16.0	.159	10	.24	-68
1.5	.04	-142	8.1	2.55	109	-15.0	.178	13	.26	-96
2.0	.09	-145	7.8	2.46	87	-14.2	.196	15	.28	-123
2.5	.14	-154	7.3	2.33	71	-13.1	.221	18	.31	-140
3.0	.22	-175	6.6	2.14	50	-12.5	.238	14	.33	-160
3.5	.28	170	5.8	1.94	32	-11.7	.260	9	.35	-173
4.0	.34	156	4.8	1.74	15	-11.3	.271	4	.34	-179
4.5	.37	140	3.9	1.57	-1	-10.7	.291	-2	.33	-171
5.0	.42	120	3.0	1.41	-16	-10.4	.302	-8	.32	-160

A model for this device is available in the DEVICE MODELS section.

**Typical Performance,  $T_A = 25^\circ\text{C}$**

(unless otherwise noted)

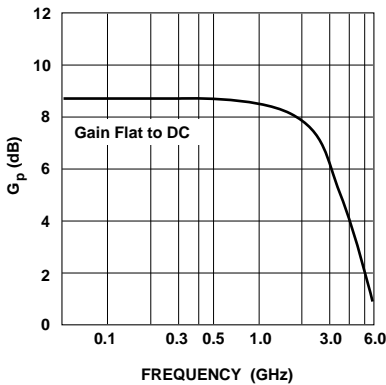

**Figure 1. Typical Power Gain vs. Frequency,  $T_A = 25^\circ\text{C}$ ,  $I_d = 50 \text{ mA}$ .**

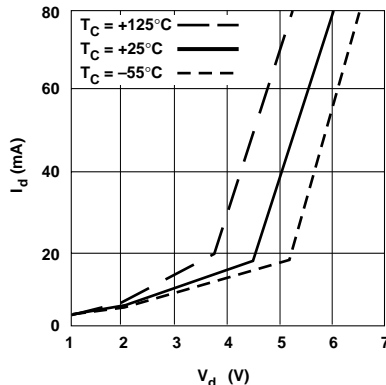

**Figure 2. Device Current vs. Voltage.**

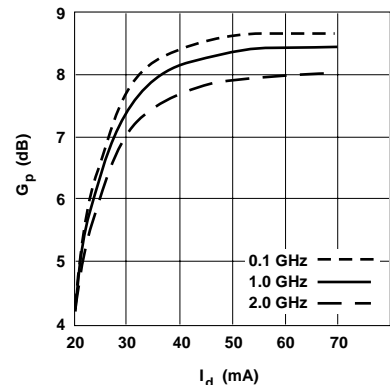

**Figure 3. Power Gain vs. Current.**

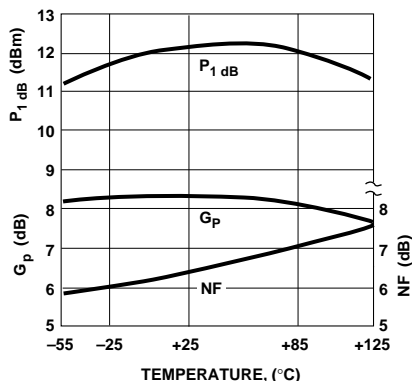

**Figure 4. Output Power at 1 dB Gain Compression, NF and Power Gain vs. Case Temperature,  $f = 1.0 \text{ GHz}$ ,  $I_d = 50 \text{ mA}$ .**

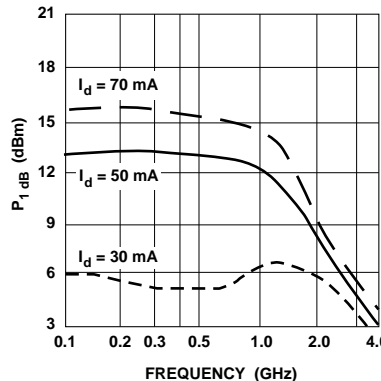

**Figure 5. Output Power at 1 dB Gain Compression vs. Frequency.**

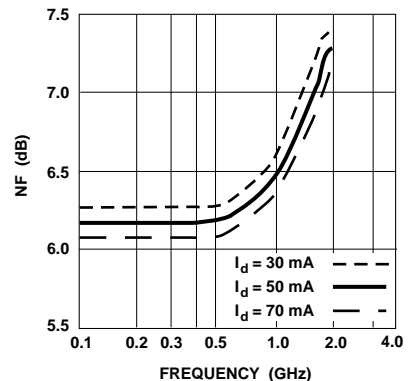

**Figure 6. Noise Figure vs. Frequency.**

### 35 micro-X Package Dimensions

