

LA6462M, 6462S

High-Performance Dual Operational Amplifiers

Overview

The LA6462 consists of two independent, internally phase compensated operational amplifiers. They feature low noise, high speed, wide band. Application areas include audio preamplifiers, active filters, and various electronic circuits.

Features

- Built-in phase compensation circuit
(Gain ≥ 10 dB recommended)
- Low noise: Equivalent input noise voltage
0.70 μV typ ($R_g = 2.2 \text{ k}\Omega$ RIAA, DIN Audio).
0.50 μV typ ($R_g = 300 \Omega$, IHF-A)
- High speed: Slew rate 4.0 V/ μs typ.
- Wide band: Gain-bandwidth product 6 MHz typ.

Package Dimensions

unit : mm

3032-MFP8

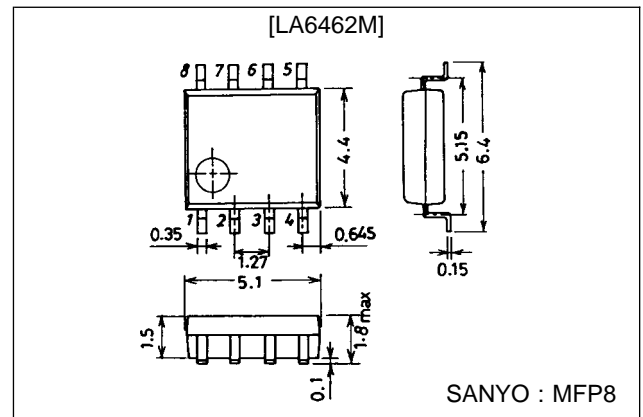

unit : mm

3017C-SIP9

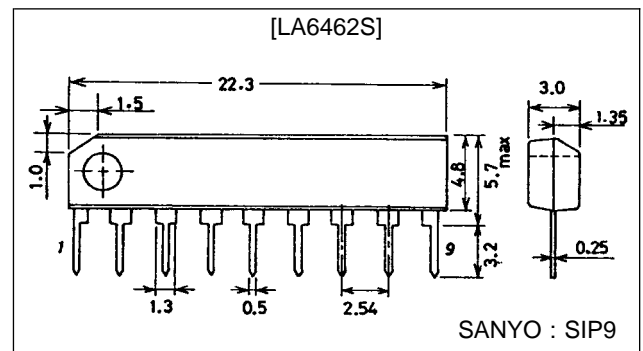

Specifications

Maximum Ratings at $T_a = 25^\circ\text{C}$

Parameter	Symbol	Conditions	Ratings	Unit
Maximum supply voltage	V_{CC}/V_{EE}		± 18	V
Differential input voltage	V_{ID}		± 30	V
Common-mode input voltage	V_{IN}		± 15	V
Allowable power dissipation	Pd max	LA6462M	300	mW
		LA6462S	500	mW
Operating temperature	Topr		-20 to +75	$^\circ\text{C}$
Storage temperature	Tstg		-40 to +125	$^\circ\text{C}$

SANYO Electric Co., Ltd. Semiconductor Business Headquarters

TOKYO OFFICE Tokyo Bldg., 1-10, 1 Chome, Ueno, Taito-ku, TOKYO, 110 JAPAN

53096HA(II)/4050YT/8077KI/3277KI, TS No. 2064-1/5

LA6462M, 6462S

Operating Characteristics at $T_a = 25^\circ\text{C}$, $V_{CC} = 15\text{ V}$, $V_{EE} = -15\text{ V}$

Parameter	Symbol	Conditions	min	typ	max	Unit
Input offset voltage	V_{IO}	$R_S = 10\text{ k}\Omega$		0.3	6.0	mV
Input offset current	I_{IO}			5	200	nA
Input bias current	I_B			200	500	nA
Common-mode input voltage	V_{ICM}		± 12	± 14		V
Common-mode rejection ratio	CMRR		70	90		dB
Voltage gain	V_{G0}	$R_L \geq 2\text{ k}\Omega$, $V_O = \pm 10\text{ V}$	96	110		dB
Maximum output voltage	$V_O(1)$	$R_L \geq 10\text{ k}\Omega$		± 14		V
	$V_O(2)$	$R_L \geq 2\text{ k}\Omega$		± 13		V
Slew rate	SR	$V_G = 0$, $R_L \geq 2\text{ k}\Omega$		4.0		V/ μs
Equivalent input noise voltage	$V_{NI}(1)$	$R_g = 2.2\text{ k}\Omega$, RIAA, DIN audio weight		0.70		μV
	$V_{NI}(2)$	$R_g = 300\ \Omega$, IHF-A weight		0.50		μV
Current drain	I_{CC}			6.0		mA
Power dissipation	P_d			180		mW
Gain-bandwidth product	f_T			6		MHz

Test Circuits

(1) V_{IO} , SVRR

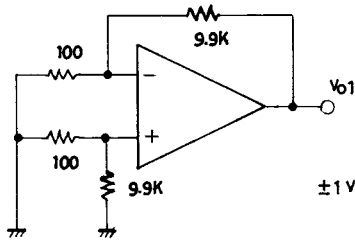

$\cdot V_{IO}: V_{CC}/V_{EE} = \pm 15\text{V}$

$\cdot \text{SVRR}: \begin{cases} V_{CC} = 15\text{V}, 5\text{V} \\ V_{EE} = -5\text{V}, -15\text{V} \end{cases}$

(2) V_O

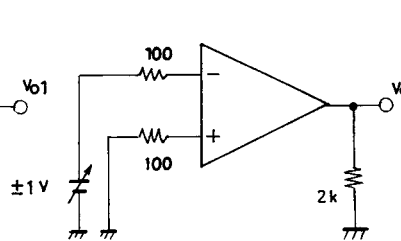

$\cdot V_{IO} = v_{O1} / 100$

$\left. \begin{matrix} \text{SVR}(+) \\ \text{SVR}(-) \end{matrix} \right\} = \left| \frac{\Delta v_{O1}}{100 \times 10\text{V}} \right|$

(3) CMRR, V_{ICM}

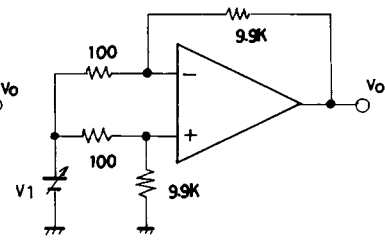

$\cdot \text{CMRR } V_1 = \pm 7.5\text{V}$

$\text{CMR} = 20 \log \frac{15 \times 100}{|\Delta v_{O'}|}$

(4) $I_B(+)$

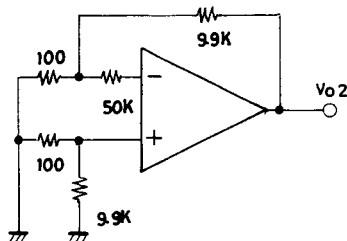

$\cdot I_B(+) = \frac{|v_{O2} - v_{O1}|}{50\text{k}\Omega \times 100}$

(5) $I_B(-)$

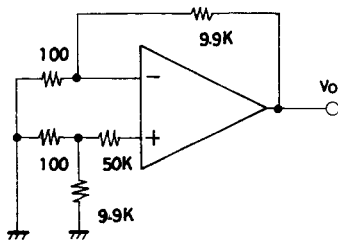

$\cdot I_B(-) = \frac{|v_{O3} - v_{O1}|}{50\text{k}\Omega \times 100}$

(6) I_{IO}

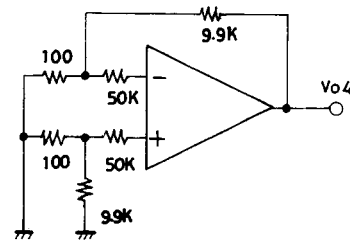

$\cdot I_{IO} = \frac{|v_{O4} - v_{O1}|}{50\text{k}\Omega \times 100}$

(7) I_{CC}

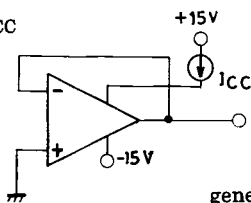

(8) SR

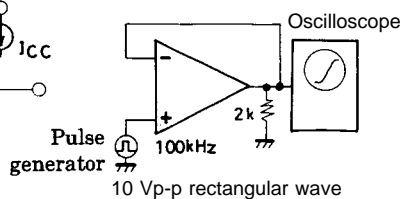

(9) V_{G0}

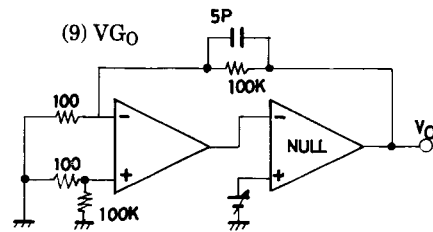

$\cdot V_{G0} = 20 \log \frac{1000 \times 20}{\Delta v_O}$

LA6462M, 6462S

(10) V_{NI}

RIAA (36dB/1kHz)
Total Gain 80dB/1kHz

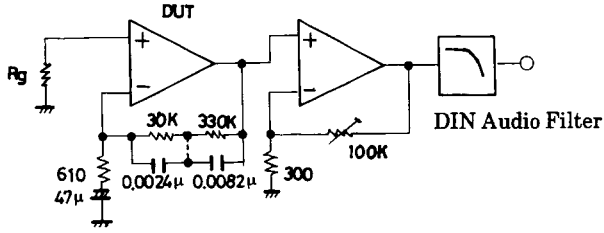

Unit (resistance: Ω , capacitance: F)

Pin Assignments

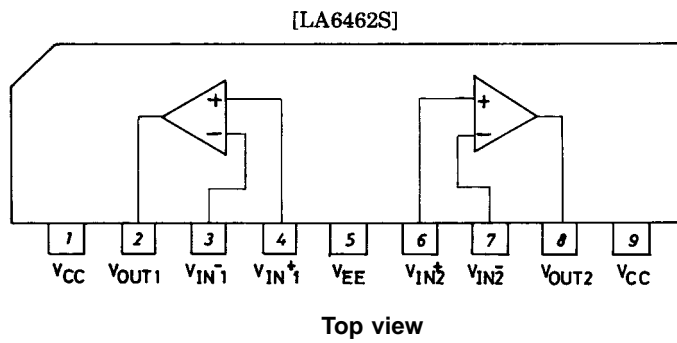
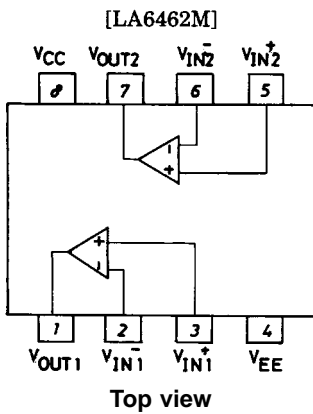

Equivalent Circuit

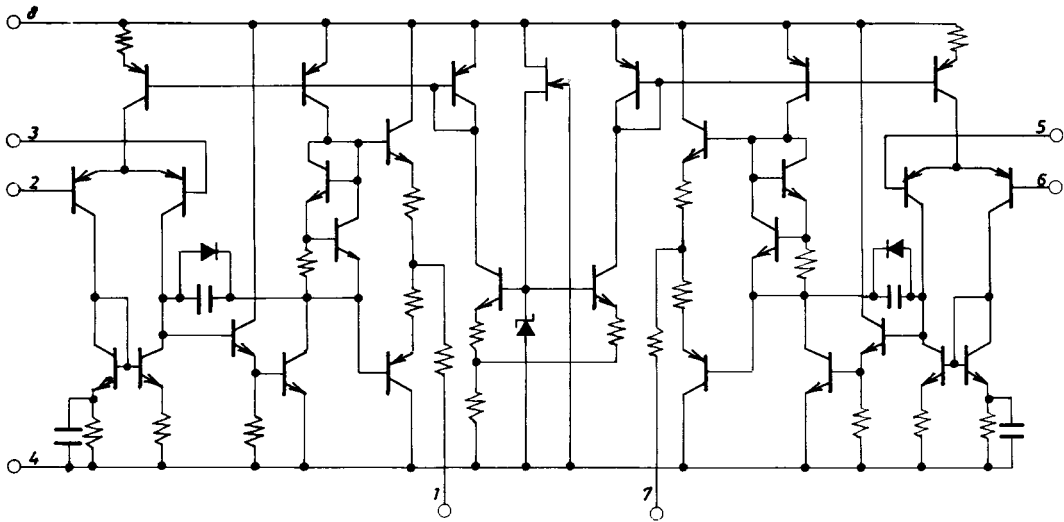

LA6462M, 6462S

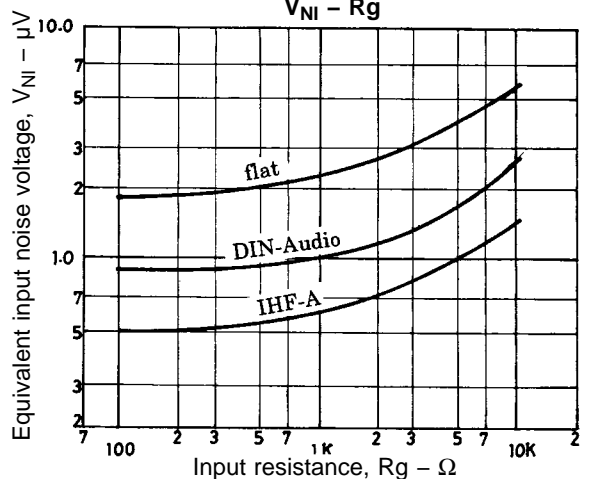
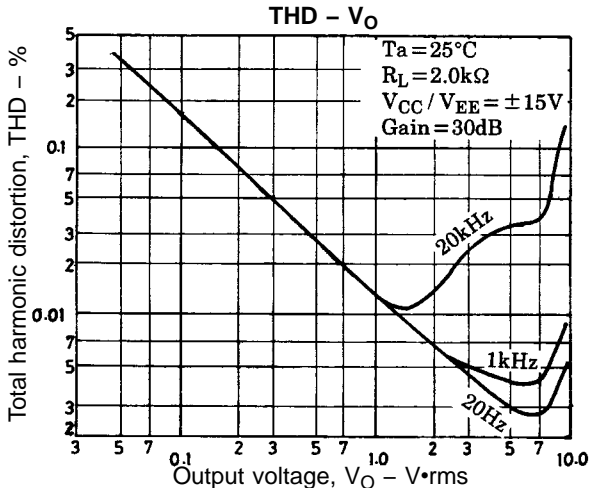
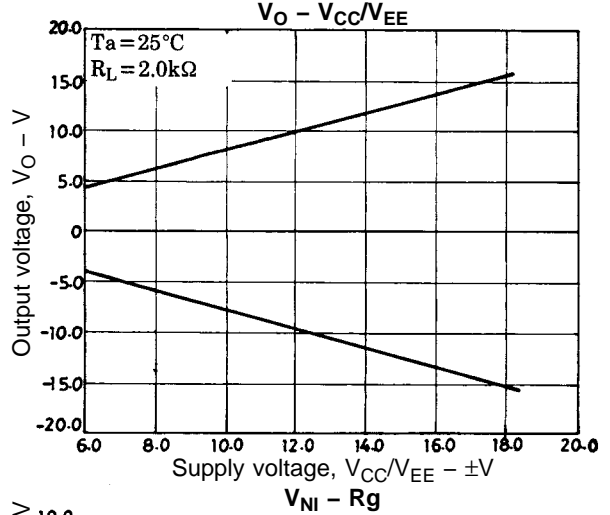
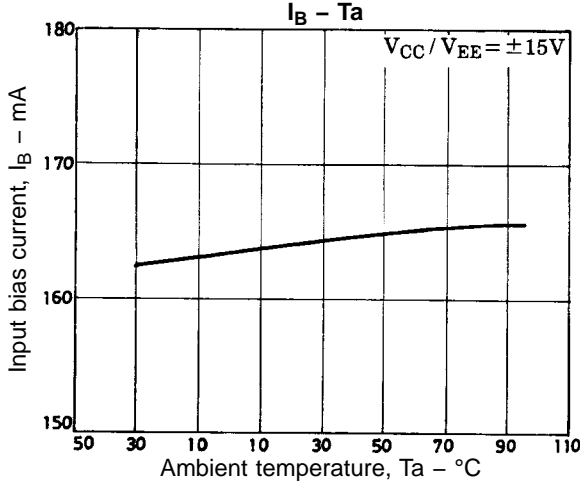
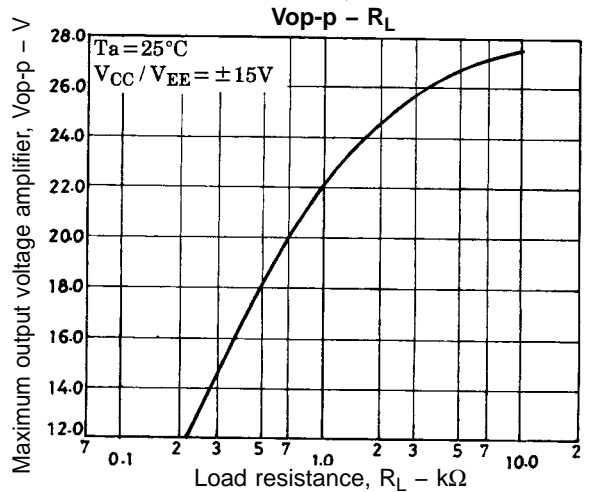
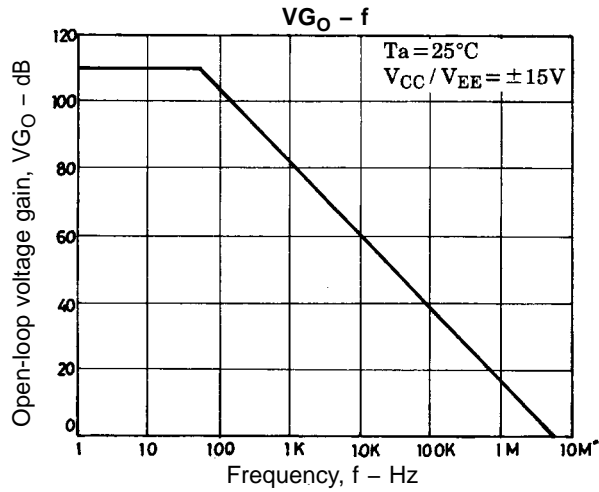
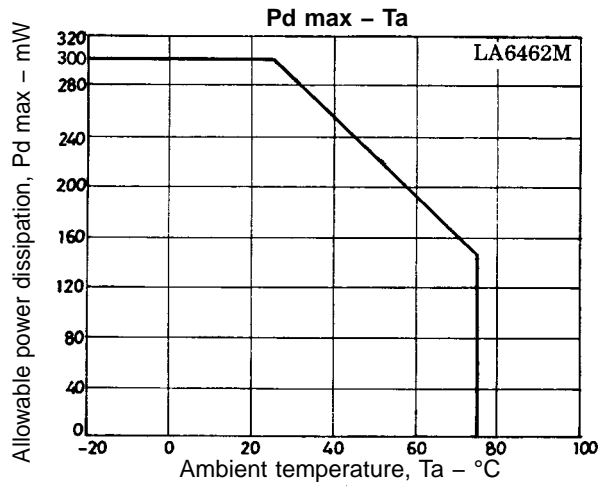
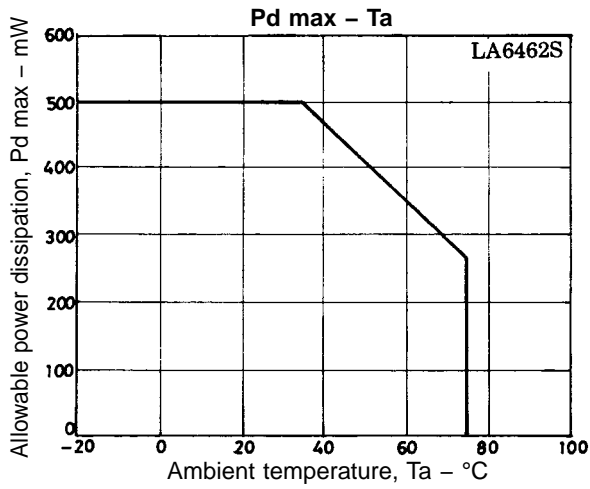

- No products described or contained herein are intended for use in surgical implants, life-support systems, aerospace equipment, nuclear power control systems, vehicles, disaster/crime-prevention equipment and the like, the failure of which may directly or indirectly cause injury, death or property loss.
- Anyone purchasing any products described or contained herein for an above-mentioned use shall:
 - ① Accept full responsibility and indemnify and defend SANYO ELECTRIC CO., LTD., its affiliates, subsidiaries and distributors and all their officers and employees, jointly and severally, against any and all claims and litigation and all damages, cost and expenses associated with such use:
 - ② Not impose any responsibility for any fault or negligence which may be cited in any such claim or litigation on SANYO ELECTRIC CO., LTD., its affiliates, subsidiaries and distributors or any of their officers and employees jointly or severally.
- Information (including circuit diagrams and circuit parameters) herein is for example only; it is not guaranteed for volume production. SANYO believes information herein is accurate and reliable, but no guarantees are made or implied regarding its use or any infringements of intellectual property rights or other rights of third parties.

This catalog provides information as of May, 1996. Specifications and information herein are subject to change without notice.