

**KPC814A • KPC824A • KPC844A**

These Photocouplers consist of two Gallium Arsenide Infrared Emitting Diodes connected in a reverse-paralled configuration for AC-input and a Silicon NPN Phototransistor per a channel.

- The KPC814A has one channel in a 4-pin DIP package.
- The KPC824A has two channels in a 8-pin DIP package.
- The KPC844A has four channels in a 16-pin DIP package.

**FEATURES**

- Small Package Size
- Collector-Emitter Voltage : Min.35V
- Current Transfer Ratio : 50% Min.(at  $I_F = \pm 1\text{mA}$ )
- Electrical Isolation Voltage : AC5000V<sub>rms</sub>
- UL Recognized File No. E107486
- VDE Approval No. 0884

**APPLICATIONS**

- AC Signal Input
- Interface between two circuits of difference
- Vending Machine
- Cordless Phone, Key Phone
- Programmable Logic Control

**DIMENSION**

(Unit : mm)

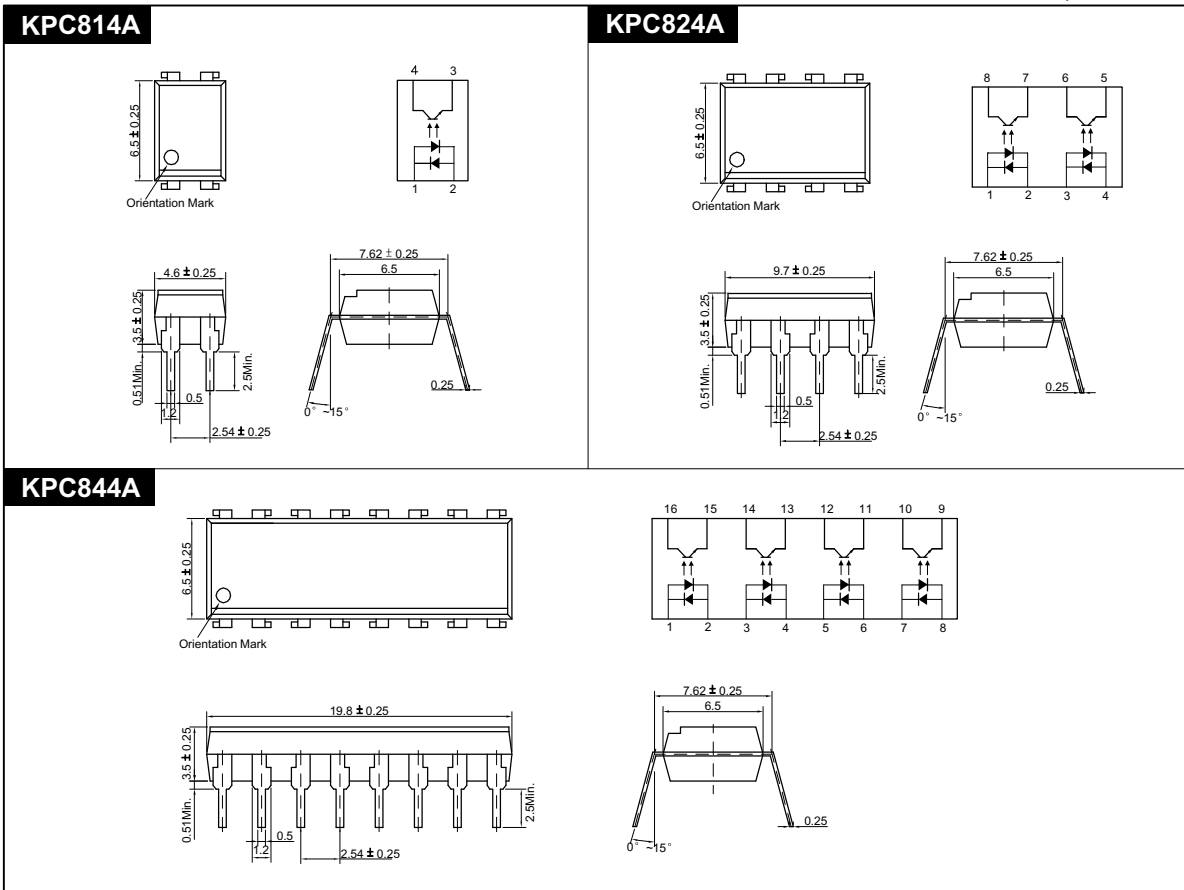

## KPC814A • KPC824A • KPC844A

### MAXIMUM RATINGS

(Ta=25 )

Parameter		Symbol	Rating	Unit
Input	Forward Current	IF	± 50	mA
	Peak Forward Current <sup>*1</sup>	IFP	± 1	A
	Power Dissipation	PD	70	mW
Output	Collector-Emitter Breakdown Voltage	BVCEO	35	V
	Emitter-Collector Breakdown Voltage	BVECO	6	V
	Collector Current	IC	50	mA
	Collector Power Dissipation	PC	150	mW
Input to Output Isolation Voltage <sup>*2</sup>		Viso	AC5000	Vrms
Storage Temperature		Tstg	-55~+125	
Operating Temperature		Topr	-30~+100	
Lead Soldering Temperature <sup>*3</sup>		Tsol	260	
Total Power Dissipation		Ptot	200	mW

\*1. Input current with 100μs pulse width, 1% duty cycle

\*2. Measured at RH=40~60% for 1min

\*3. 1/16 inch form case for 10sec

### ELECTRO-OPTICAL CHARACTERISTICS

(Ta=25 , unless otherwise noted)

Parameter		Symbol	Condition	Min.	Typ.	Max.	Unit.
Input	Forward Voltage	VF	IF= ± 10mA	-	1.15	1.30	V
	Capacitance	CT	V=0, f=1kHz	-	30	-	pF
Output	Collector-Emitter Breakdown Voltage	BVCEO	IC=0.5mA	35	-	-	V
	Emitter-Collector Breakdown Voltage	BVECO	IE=0.1mA	6	-	-	V
	Collector Dark Current	ICEO	IF=0, VCE=24V	-	-	100	nA
	Capacitance	CCE	VCE=0, f=1kHz	-	10	-	pF
Coupled	Current Transfer Ratio <sup>*4</sup>	CTR	IF= ± 1mA, VCE=5V	50	-	600	%
	Collector-Emitter Saturation Voltage	VCE(SAT)	IF= ± 5mA, IC=1mA	-	0.15	0.4	V
	Input-Output Capacitance	CIO	V=0, f=1kHz	-	1	-	pF
	Input-Output Isolation Resistance	RIO	RH=40~60%, V=500V	-	10 <sup>11</sup>	-	
	Rise Time	tr	VCE=5V, RL=100	-	4	-	μs
	Fall Time	tf	IC=2mA	-	4	-	μs
Symmetry Ratio		CTR1/CTR2		1	-	3	

\*4. CTR=(IC/IF) X 100 (%)

KPC814A • KPC824A • KPC844A

Forward Current vs. Ambient Temperature

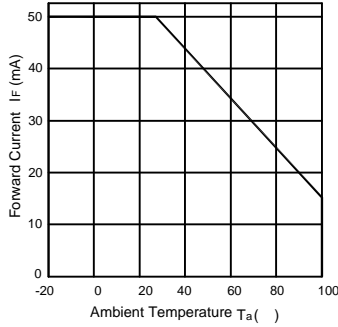

Collector Power Dissipation vs. Ambient Temperature

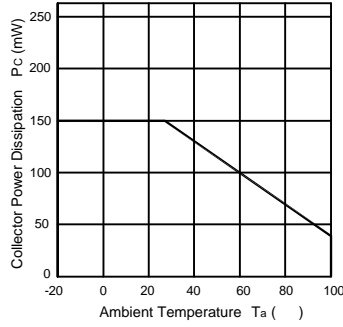

Forward Current vs. Forward Voltage

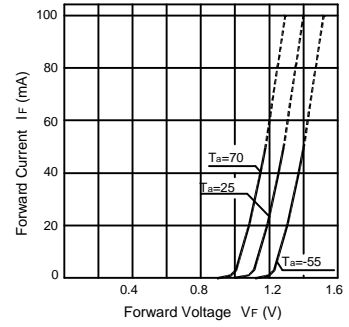

Collector Current vs. Collector-Emitter Voltage

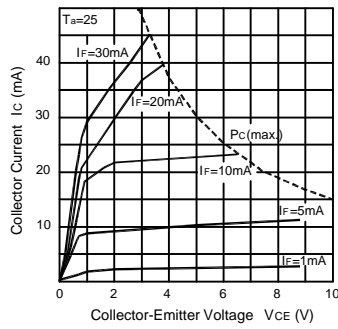

Dark Current vs. Ambient Temperature

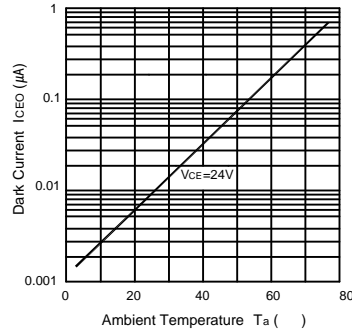

Collector Current vs. Ambient Temperature

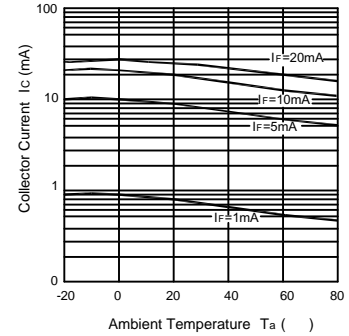

Response Time vs. Load Resistance

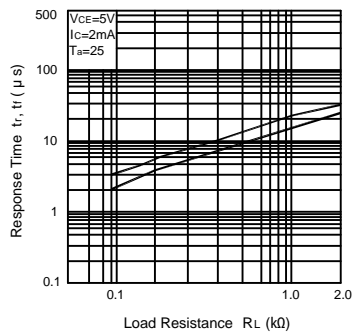

Collector Current vs. Forward Current

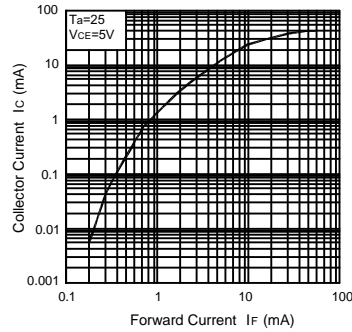

Switching Time Test Circuit

