

## GaAs MMIC SMT SINGLE BALANCED MIXER, 1.7 - 3 GHz

### Typical Applications

The HMC272MS8 is ideal for:

- Up or Down Converter for PCS
- W-CDMA
- 2.4 GHz ISM
- MMDS

### Features

- Ultra Small Package: MSOP8
- LO / RF Isolation: 32 dB
- IP3 (Input): +20 dBm

### Functional Diagram

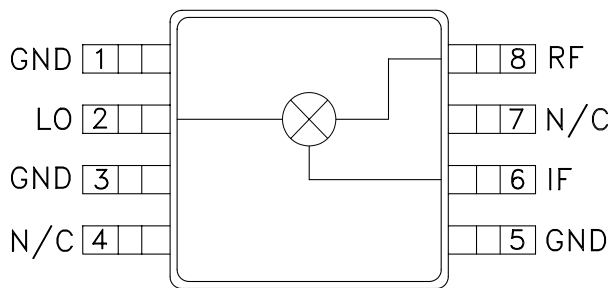

### General Description

The HMC272MS8 is an ultra miniature single balanced mixer in an 8 lead plastic surface mount Mini Small Outline Package (MSOP). This passive MMIC mixer is constructed of GaAs Schottky diodes and a novel planar transformer balun on the chip. The RF port is balanced via the MMIC balun while the LO port is connected directly to the diodes. The consistent MMIC performance will improve system operation and assure regulatory compliance.

### Electrical Specifications, $T_a = +25^\circ\text{C}$ , As a Function of IF Frequency

Parameter	LO = +10 dBm IF = 100 MHz			LO = +10 dBm IF = 400 MHz			Units
	Min.	Typ.	Max.	Min.	Typ.	Max.	
Frequency Range, RF & LO	2 - 3			1.7 - 2.8			GHz
Frequency Range, IF	DC - 0.8			DC - 0.8			GHz
Conversion Loss		9	10.5		9	11	dB
Noise Figure (SSB)		9	10.5		9	11	dB
LO to RF Isolation	22	30		24	32		dB
LO to IF Isolation	12	20		11	18		dB
IP3 (Input)	17	21		16	20		dBm
1 dB Compression (Input)	8	11		7	10		dBm

**GaAs MMIC SMT SINGLE  
BALANCED MIXER, 1.7 - 3 GHz**

**Conversion Gain vs.  
Temperature @ LO = +10 dBm**

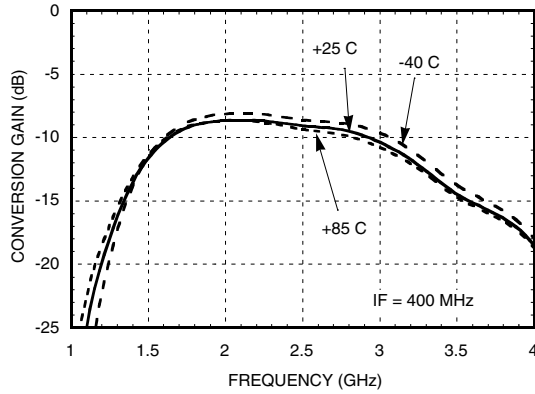

**Isolation @ LO = +10 dBm**

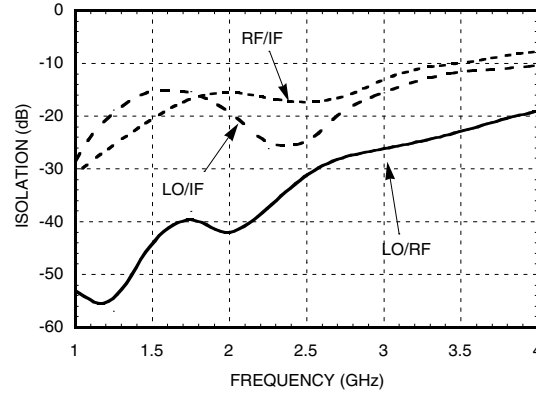

**Conversion Gain vs. LO Drive**

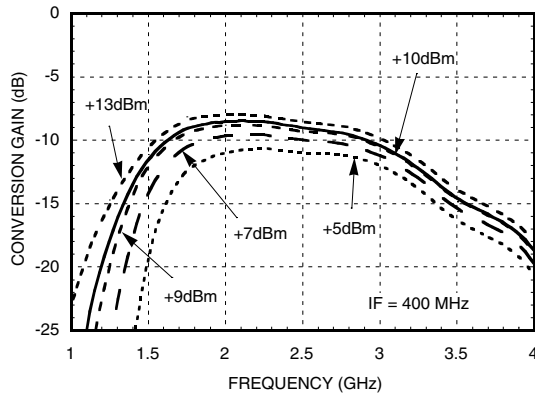

**Return Loss @ LO = +10 dBm**

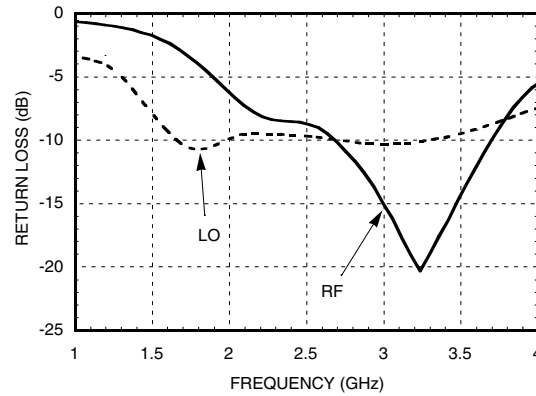

**Conversion Gain vs. IF Frequency**

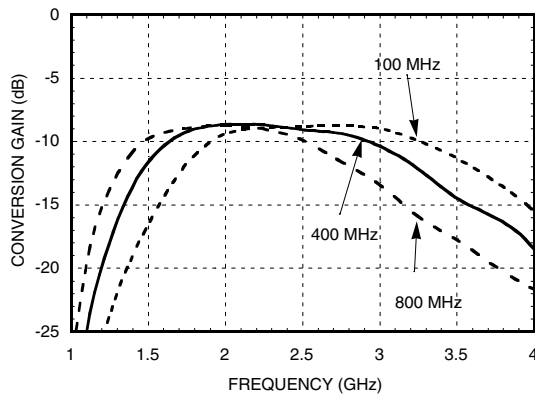

**IF Bandwidth @ LO = +10 dBm.  
Conversion Gain & Return Loss**

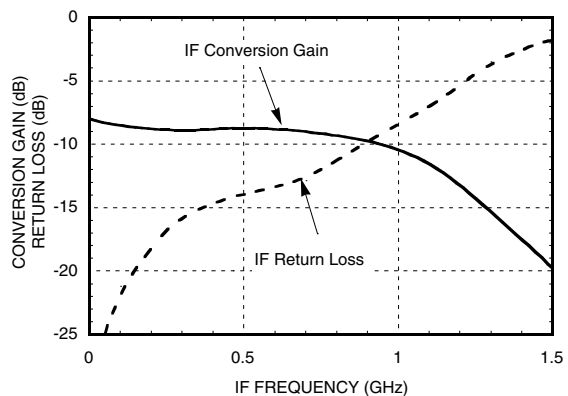

## GaAs MMIC SMT SINGLE BALANCED MIXER, 1.7 - 3 GHz

**Input IP3 vs. LO Drive**

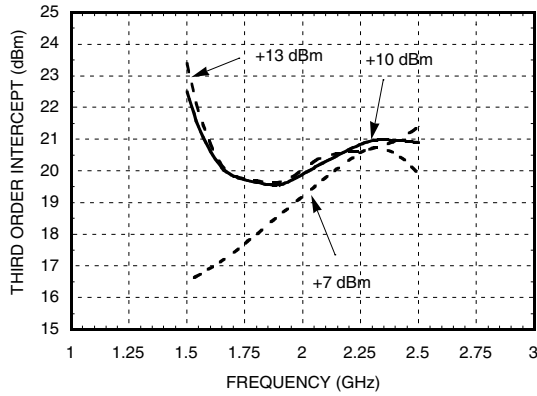

**Input IP3 vs. Temperature @ LO = +10 dBm**

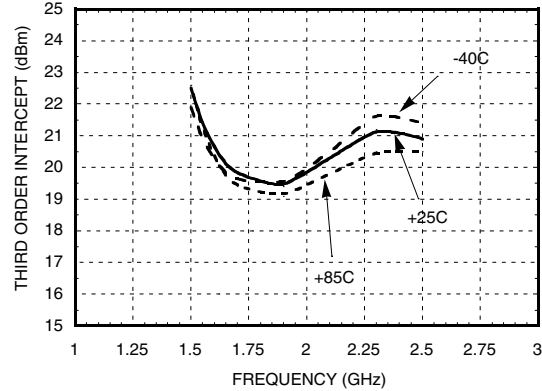

**Input IP2 vs. LO Drive**

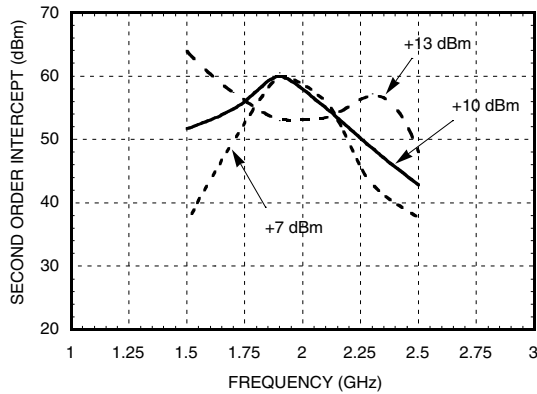

**P1dB vs. Temperature @ LO = +10 dBm**

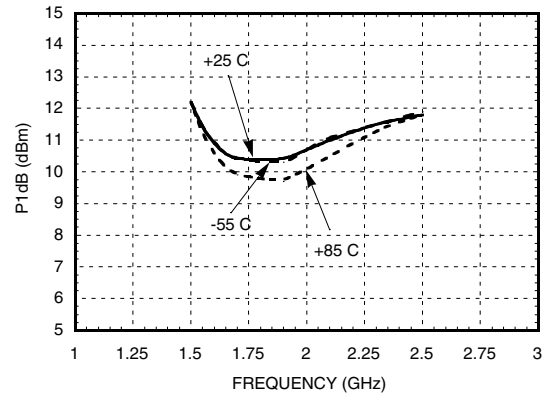

**MxN Spurious Outputs**

mRF	nLO				
	0	1	2	3	4
0	xx	-8	4	3	27
1	9	0	38	28	43
2	64	58	61	44	67
3	82	89	95	92	87
4	106	>110	>110	>107	>110

RF = 2.6 GHz @ -10 dBm  
 LO = 2.2 GHz @ +13 dBm  
 All values in dBc relative to the IF

**Harmonics of LO**

LO Frequency (GHz)	nLO Spur at RF Port			
	1	2	3	4
1.5	44	19	42	50
1.7	40	16	42	53
1.9	39	18	40	53
2.1	42	20	35	55
2.3	43	23	36	55
2.5	35	26	37	56

LO = +10 dBm  
 Values in dBc below input LO level measured at the RF port.

## GaAs MMIC SMT SINGLE BALANCED MIXER, 1.7 - 3 GHz



### Absolute Maximum Ratings

RF / IF Input	+13 dBm
LO Drive	+27 dBm
Storage Temperature	-65 to +150 °C
Operating Temperature	-40 to +85 °C

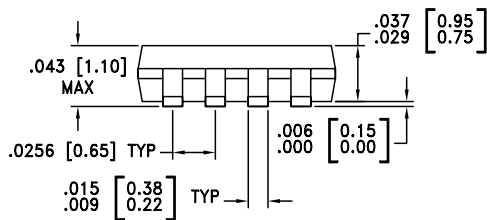
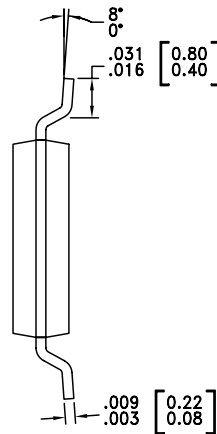
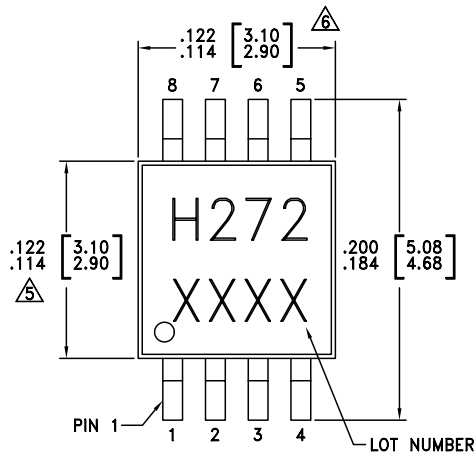
### Outline Drawing



NOTES:

1. PACKAGE BODY MATERIAL: LOW STRESS INJECTION MOLDED PLASTIC SILICA AND SILICON IMPREGNATED.
2. LEADFRAME MATERIAL: COPPER ALLOY
3. LEADFRAME PLATING: Sn/Pb SOLDER
4. DIMENSIONS ARE IN INCHES (MILLIMETERS).
5.  DIMENSION DOES NOT INCLUDE MOLDFLASH OF 0.15mm PER SIDE.
6.  DIMENSION DOES NOT INCLUDE MOLDFLASH OF 0.25mm PER SIDE.
7. ALL GROUND LEADS MUST BE SOLDERED TO PCB RF GROUND.

## GaAs MMIC SMT SINGLE BALANCED MIXER, 1.7 - 3 GHz

### Evaluation Circuit Board

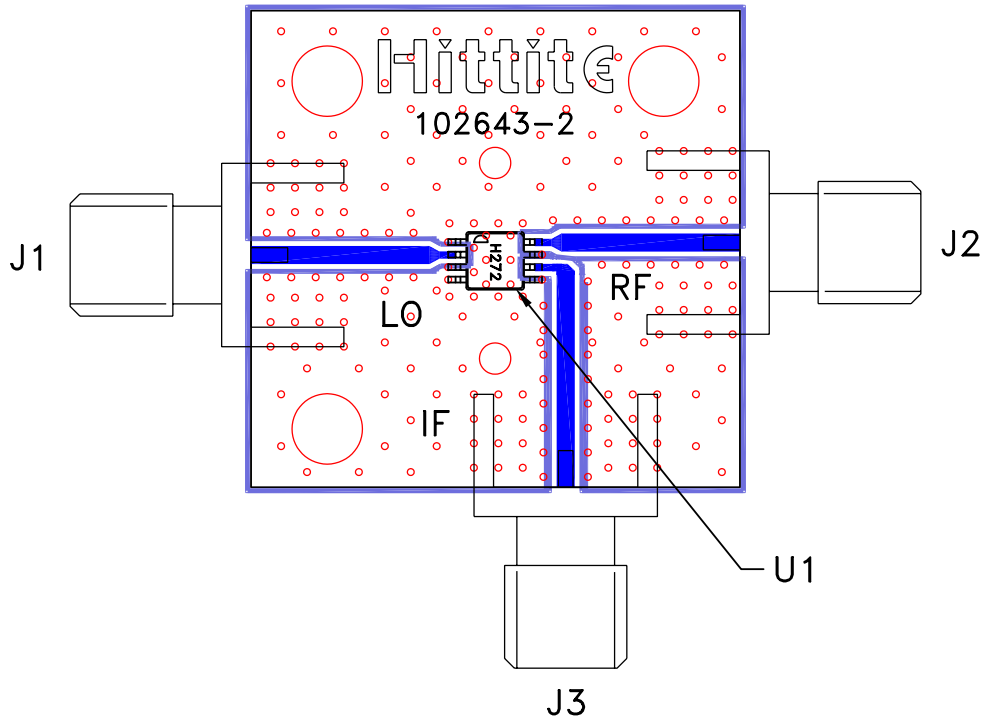

### List of Material

Item	Description
J1 - J3	PC Mount SMA RF Connector
U1	HMC272MS8 Mixer
PCB*	102643 Evaluation Board
* Circuit Board Material: Rogers 4350	

The circuit board used in the final application should use RF circuit design techniques. Signal lines should have 50 ohm impedance while the package ground leads and exposed paddle should be connected directly to the ground plane similar to that shown. A sufficient number of VIA holes should be used to connect the top and bottom ground planes. The evaluation circuit board shown is available from Hittite upon request.

## *GaAs MMIC SMT SINGLE BALANCED MIXER, 1.7 - 3 GHz*

**Notes:**