

*ASSP Mobile Communication Systems***SAW Dual Filter
(700 to 2000 MHz)****G5/G6 Series (L2/D2 type)****DESCRIPTION**

As the market for mobile phones continues to increase, so has demand for smaller size, lighter weight and lower cost. Dual band phones, such as GSM + PCN and AMPS + PCS, are rising in popularity. To support these requests, Fujitsu has developed a new series of SAW dual filter (G5/G6 series) incorporating two SAW filters in one package. For example, Fujitsu can offer a GSM Rx filter and a PCN Rx filter of combination in small 3.8 mm × 3.8 mm. package.

The G5/G6 series of SAW dual filter applies to the 700 to 2000 MHz, frequency range, and are available in two package types : 2 input/2 output type or 1 input/2 output (2 input/1 output) .

FEATURES

- Two functions are incorporated in one package
(Useful for multi-band phone and multi-mode phone)
- Ultra compact and light package (3.8 mm × 3.8 mm. or 3.0 mm × 3.0 mm.)
- 50 Ω of input/output impedance
- Low insertion loss
- 2 in/2 out and 1 in/2 out (2 in/1 out) of package types are available

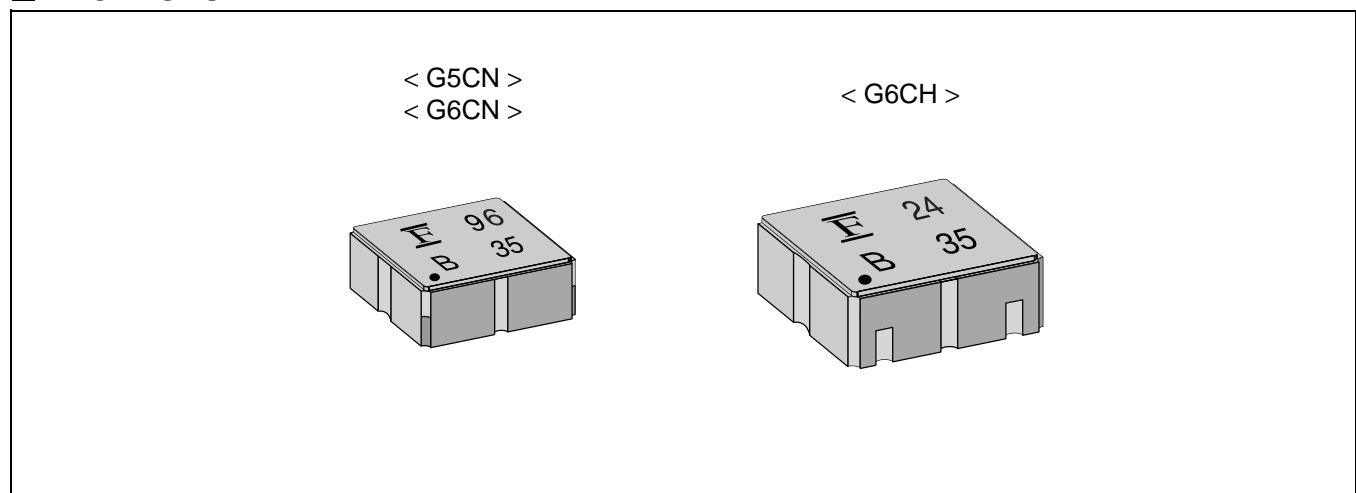
PACKAGES

G5/G6 Series

PIN ASSIGNMENTS

< BOTTOM VIEW >

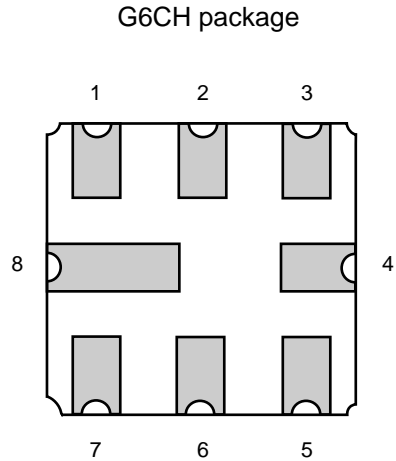
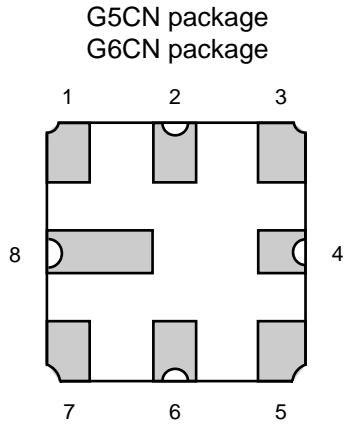

1 in/2 out type

Pin	Pin name	Description
1	IN	Input Pin (Common)
2	GND	Ground Pin
3	GND	Ground Pin
4	GND	Ground Pin
5	OUT	Filter 2 Output Pin
6	GND	Ground Pin
7	OUT	Filter 1 Output Pin
8	GND	Ground Pin

2 in/2 out type

Pin	Pin name	Description
1	IN	Filter 1 Input Pin
2	GND	Ground Pin
3	IN	Filter 2 Input Pin
4	GND	Ground Pin
5	OUT	Filter 2 Output Pin
6	GND	Ground Pin
7	OUT	Filter 1 Output Pin
8	GND	Ground Pin

INTERNAL BLOCK DIAGRAM

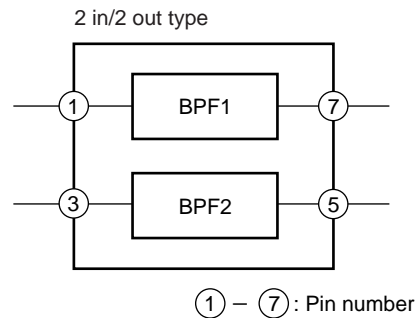
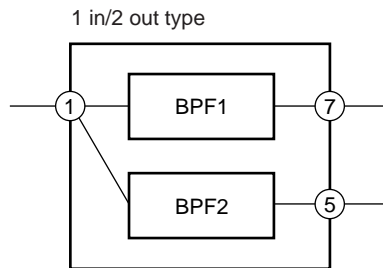

■ ABSOLUTE MAXIMUM RATINGS

Parameter	Symbol	Rating		Unit
		Min.	Max.	
Operating temperature	Ta	-30	+85	°C
Storage temperature	Tstg	-40	+100	°C
Maximum input power	P _{IN}	Depends on each design. See "■ ELECTRICAL CHARACTERISTICS".		
Input DC voltage	—	-5	+5	V

WARNING: Piezoelectric devices can be permanently damaged by application of stress (voltage, current, temperature, etc.) in excess of absolute maximum ratings. Do not exceed these ratings.

■ RECOMMENDED OPERATING CONDITIONS

Parameter	Symbol	Value		Unit
		Min.	Max.	
Operating temperature	Ta	-30	+85	°C

WARNING: The recommended operating conditions are required in order to ensure the normal operation of the piezoelectric device. All of the device's electrical characteristics are warranted when the device is operated within these ranges.

Always use piezoelectric devices within their recommended operating condition ranges. Operation outside these ranges may adversely affect reliability and could result in device failure.

No warranty is made with respect to uses, operating conditions, or combinations not represented on the data sheet. Users considering application outside the listed conditions are advised to contact their FUJITSU representatives beforehand.

G5/G6 Series

■ STANDARD FREQUENCIES

No.	Part number	System		Frequency (MHz)	Part symbol	Input/Output	Remarks
1	FAR-G5CN-942M50-D296	PDC800 Tx		893 to 898 MHz	96	1 in/ 2 out	3.0 × 3.0 mm
				925 to 960 MHz			
2	FAR-G5CN-877M50-D292	PDC800 Rx		810 to 843 MHz	92	1 in/ 2 out	3.0 × 3.0 mm
				870 to 885 MHz			
3	FAR-G6CH-1G8800-L214	AMPS/TDMA/CDMA + PCS Tx		824 to 849 MHz	14	2 in/ 2 out	3.8 × 3.8 mm
				1850 to 1910 MHz			
4	FAR-G6CH-1G9600-L215	AMPS/TDMA/CDMA + PCS Rx		869 to 894 MHz	15	2 in/ 2 out	3.8 × 3.8 mm
				1930 to 1990 MHz			
5	FAR-G6CH-1G7475-L216	GSM + PCN Tx		890 to 915 MHz	16	2 in/ 2 out	3.8 × 3.8 mm
				1710 to 1785 MHz			
6	FAR-G6CH-1G8425-L217	GSM + PCN Rx		935 to 960 MHz	17	2 in/ 2 out	3.8 × 3.8 mm
				1805 to 1880 MHz			
7	FAR-G6CH-1G8425-L218	EGSM + PCN Rx		925 to 960 MHz	18	2 in/ 2 out	3.8 × 3.8 mm Low insertion loss type
				1805 to 1880 MHz			
8	FAR-G6CH-1G8425-L222	EGSM + PCN Rx		925 to 960 MHz	22	2 in/ 2 out	3.8 × 3.8 mm High Aff. type
				1805 to 1880 MHz			
9	FAR-G6CH-1G8425-L227B	EGSM + PCN Rx		925 to 960 MHz	27	2 in/ 2 out	3.8 × 3.8 mm
				1805 to 1880 MHz			
10	FAR-G6CH-1G9600-L228A	EGSM + PCS Rx		925 to 960 MHz	28	2 in/ 2 out	3.8 × 3.8 mm
				1930 to 1990 MHz			
11	FAR-G6CH-1G9600-L219	PCN + PCS Rx		1805 to 1880 MHz	19	2 in/ 2 out	3.8 × 3.8 mm
				1930 to 1990 MHz			
12	FAR-G6CN-1G8950-L233	PCS Tx Split	Low	1850 to 1880 MHz	33	2 in/ 2 out	3.0 × 3.0 mm
			High	1880 to 1910 MHz			
13	FAR-G6CH-1G9750-L230	PCS Rx Split	Low	1930 to 1960 MHz	30	2 in/ 2 out	3.8 × 3.8 mm
			High	1960 to 1990 MHz			

■ ELECTRICAL CHARACTERISTICS

1. PDC800 (Tx) 1 in/2 out

Part number : FAR-G5CN-942M50-D296

(Ta = -30 °C to +85 °C)

Parameter	Condition	Value			Unit	Remarks	
		Min.	Typ.	Max.			
Filter 1	Insertion Loss	893 to 898 MHz	—	—	4.0	dB	-30 to +20 °C
		893 to 898 MHz	—	2.7	3.5	dB	+20 to +30 °C
		893 to 898 MHz	—	—	3.5	dB	+30 to +85 °C
	Inband Ripple	893 to 898 MHz	—	0.5	1.5	dB	
	Absolute Attenuation	520 to 570 MHz	40	48	—	dB	
		570 to 640 MHz	35	40	—	dB	
		640 to 750 MHz	30	33	—	dB	
		750 to 810 MHz	24	28	—	dB	
		810 to 870 MHz	15	21	—	dB	
		870 to 885 MHz	11	—	—	dB	-30 to +20 °C
			11	18	—	dB	+20 to +30 °C
			7	—	—	dB	+30 to +85 °C
		925 to 1000 MHz	10	17	—	dB	
	1000 to 1200 MHz	25	31	—	dB		
Inband VSWR (Return Loss)	893 to 898 MHz	— (6.0)	1.9 (10.2)	3.0 —	— (dB)		
Max. Input Power	893 to 898 MHz	—	—	15	dBm		
Filter 2	Insertion Loss	925 to 960 MHz	—	2.9	4.0	dB	
	Inband Ripple	925 to 960 MHz	—	1.6	2.7	dB	
	Absolute Attenuation	550 to 650 MHz	38	42	—	dB	
		650 to 700 MHz	40	51	—	dB	
		700 to 780 MHz	32	36	—	dB	
		780 to 885 MHz	23	33	—	dB	
		1000 to 1050 MHz	14	17	—	dB	
		1050 to 1200 MHz	30	35	—	dB	
	Inband VSWR (Return Loss)	925 to 960 MHz	— (6.0)	1.9 (10.2)	3.0 —	— (dB)	
Max. Input Power	925 to 960 MHz	—	—	15	dBm		

G5/G6 Series

2. PDC800 (Rx) 1 in/2 out Part number : FAR-G5CN-877M50-D292

(Ta = -30 °C to +85 °C)

Parameter	Condition	Value			Unit	Remarks	
		Min.	Typ.	Max.			
Filter 1	Insertion Loss	810 to 843 MHz	—	2.6	4.0	dB	
	Inband Ripple	810 to 843 MHz	—	0.8	2.2	dB	
	Absolute Attenuation	550 to 585 MHz	40	47	—	dB	
		585 to 650 MHz	28	32	—	dB	
		650 to 780 MHz	20	24	—	dB	
		865 to 889 MHz	16	19	—	dB	
		889 to 900 MHz	19	23	—	dB	
		900 to 1070 MHz	20	27	—	dB	
		1070 to 1110 MHz	30	33	—	dB	
Inband VSWR (Return Loss)	810 to 828 MHz	— (6.5)	2.1 (9.0)	2.8 —	— (dB)		
Max. Input Power	810 to 828 MHz	—	—	15	dBm		
Filter 2	Insertion Loss	870 to 885 MHz	—	2.7	3.5	dB	
	Inband Ripple	870 to 885 MHz	—	0.2	1.0	dB	
	Absolute Attenuation	610 to 630 MHz	40	46	—	dB	
		630 to 700 MHz	35	40	—	dB	
		700 to 840 MHz	20	27	—	dB	
		925 to 960 MHz	15	19	—	dB	
		960 to 1130 MHz	30	37	—	dB	
		1130 to 1145 MHz	32	35	—	dB	
	Inband VSWR (Return Loss)	870 to 885 MHz	— (7.4)	1.9 (10.2)	2.5 —	— (dB)	
Max. Input Power	870 to 885 MHz	—	—	15	dBm		

3. AMPS/TDMA/CDMA Tx + PCS Tx (2 in/2 out) Part number : FAR-G6CH-1G8800-L214

(Ta = -30 °C to +85 °C)

Parameter	Condition	Value			Unit	Remarks	
		Min.	Typ.	Max.			
Filter 1	Insertion Loss	824 to 849 MHz	—	2.9	3.6	dB	
	Inband Ripple	824 to 849 MHz	—	0.9	1.6	dB	
	Absolute Attenuation	DC to 800 MHz	40	45	—	dB	
		869 to 894 MHz	28	32	—	dB	
		1000 to 1500 MHz	40	47	—	dB	
		1500 to 2000 MHz	25	33	—	dB	
	Inband VSWR (Return Loss)	824 to 849 MHz	— (9.5)	1.6 (12.7)	2.0 —	— (dB)	
Max. Input Power	824 to 849 MHz	—	—	15	dBm		
Filter 2	Insertion Loss	1850 to 1910 MHz	—	3.2	4.3	dB	
	Inband Ripple	1850 to 1910 MHz	—	1.6	2.7	dB	
	Absolute Attenuation	DC to 1500 MHz	21	23	—	dB	
		1500 to 1800 MHz	23	25	—	dB	
		1930 to 1990 MHz	7	17	—	dB	
		2000 to 2100 MHz	28	33	—	dB	
		2200 to 3000 MHz	19	23	—	dB	
		3000 to 4000 MHz	15	19	—	dB	
	Inband VSWR (Return Loss)	1850 to 1910 MHz	— (8.1)	1.8 (10.9)	2.3 —	— (dB)	
Max. Input Power	1850 to 1910 MHz	—	—	13	dBm		

G5/G6 Series

4. AMPS/TDMA/CDMA Rx + PCS Rx (2 in/2 out) Part number : FAR-G6CH-1G9600-L215

(Ta = -30 °C to +85 °C)

Parameter	Condition	Value			Unit	Remarks	
		Min.	Typ.	Max.			
Filter 1	Insertion Loss	869 to 894 MHz	—	3.0	3.6	dB	
	Inband Ripple	869 to 894 MHz	—	1.0	1.6	dB	
	Absolute Attenuation	DC to 800 MHz	42	50	—	dB	
		824 to 849 MHz	30	45	—	dB	
		920 to 1000 MHz	28	30	—	dB	
		1000 to 1500 MHz	40	45	—	dB	
	1500 to 2000 MHz	23	32	—	dB		
	Inband VSWR (Return Loss)	869 to 894 MHz	— (9.5)	1.5 (14.0)	2.0 —	— (dB)	
Max. Input Power	869 to 894 MHz	—	—	15	dBm		
Filter 2	Insertion Loss	1930 to 1990 MHz	—	3.2	4.3	dB	
	Inband Ripple	1930 to 1990 MHz	—	1.5	2.6	dB	
	Absolute Attenuation	DC to 1500 MHz	21	23	—	dB	
		1500 to 1850 MHz	23	25	—	dB	
		1850 to 1910 MHz	8	25	—	dB	
		2040 to 2200 MHz	25	30	—	dB	
		2500 to 3000 MHz	20	24	—	dB	
	3000 to 4000 MHz	15	18	—	dB		
Inband VSWR (Return Loss)	1930 to 1990 MHz	— (8.1)	1.5 (14.0)	2.3 —	— (dB)		
Max. Input Power	1930 to 1990 MHz	—	—	13	dBm		

5. GSM Tx + PCN Tx (2 in/2 out)
Part number : FAR-G6CH-1G7475-L216

(Ta = -30 °C to +85 °C)

Parameter	Condition	Value			Unit	Remarks	
		Min.	Typ.	Max.			
Filter 1	Insertion Loss	890 to 915 MHz	—	3.1	3.6	dB	
	Inband Ripple	890 to 915 MHz	—	1.2	1.7	dB	
	Absolute Attenuation	DC to 800 MHz	45	50	—	dB	
		800 to 870 MHz	30	43	—	dB	
		935 to 960 MHz	28	31	—	dB	
		1000 to 1500 MHz	40	45	—	dB	
	1500 to 2000 MHz	25	34	—	dB		
	Inband VSWR (Return Loss)	890 to 915 MHz	— (9.5)	1.5 (14.0)	2.0 —	— (dB)	
Max. Input Power	890 to 915 MHz	—	—	15	dBm		
Filter 2	Insertion Loss	1710 to 1785 MHz	—	3.0	4.3	dB	
	Inband Ripple	1710 to 1785 MHz	—	1.6	2.9	dB	
	Absolute Attenuation	DC to 1500 MHz	17	18	—	dB	
		1500 to 1670 MHz	22	26	—	dB	
		1805 to 1880 MHz	7	19	—	dB	
		1900 to 2000 MHz	25	28	—	dB	
	2100 to 3000 MHz	20	24	—	dB		
	3000 to 3570 MHz	15	19	—	dB		
Inband VSWR (Return Loss)	1710 to 1785 MHz	— (7.7)	1.8 (10.9)	2.4 —	— (dB)		
Max. Input Power	1710 to 1785 MHz	—	—	13	dBm		

G5/G6 Series

6. GSM Rx + PCN Rx (2 in/2 out) Part number : FAR-G6CH-1G8425-L217

(Ta = -30 °C to +85 °C)

Parameter	Condition	Value			Unit	Remarks	
		Min.	Typ.	Max.			
Filter 1	Insertion Loss	935 to 960 MHz	—	3.1	3.5	dB	
	Inband Ripple	935 to 960 MHz	—	1.1	1.5	dB	
	Absolute Attenuation	DC to 800 MHz	45	53	—	dB	
		890 to 915 MHz	30	43	—	dB	
		980 to 1030 MHz	25	30	—	dB	
		1100 to 1500 MHz	40	45	—	dB	
		1500 to 2000 MHz	25	36	—	dB	
	Inband VSWR (Return Loss)	930 to 960 MHz	— (9.5)	1.6 (12.7)	2.0 —	— (dB)	
Max. Input Power	930 to 960 MHz	—	—	15	dBm		
Filter 2	Insertion Loss	1805 to 1880 MHz	—	2.8	4.0	dB	
	Inband Ripple	1805 to 1880 MHz	—	1.2	2.4	dB	
	Absolute Attenuation	DC to 1300 MHz	17	18	—	dB	
		1355 to 1430 MHz	17	20	—	dB	
		1500 to 1710 MHz	20	22	—	dB	
		1710 to 1785 MHz	11	25	—	dB	
		1920 to 1980 MHz	20	30	—	dB	
		2000 to 3000 MHz	22	25	—	dB	
		3000 to 3760 MHz	15	18	—	dB	
Inband VSWR (Return Loss)	1805 to 1880 MHz	— (7.7)	2.0 (9.5)	2.4 —	— (dB)		
Max. Input Power	1805 to 1880 MHz	—	—	13	dBm		

7. EGSM Rx + PCN Rx (2 in/2 out)
Part number : FAR-G6CH-1G8425-L218

(Ta = -30 °C to +85 °C)

Parameter	Condition	Value			Unit	Remarks	
		Min.	Typ.	Max.			
Filter 1	Insertion Loss	925 to 960 MHz	—	—	2.5	dB	+20 to +30 °C
			—	2.2	3.0	dB	-30 to +85 °C
	Inband Ripple	925 to 960 MHz	—	0.8	1.6	dB	
	Absolute Attenuation	DC to 880 MHz	16	18	—	dB	
		880 to 915 MHz	10	—	—	dB	+20 to +30 °C
			5	17	—	dB	-30 to +85 °C
		980 to 1200 MHz	13	22	—	dB	
		1375 to 1410 MHz	20	24	—	dB	
		1850 to 1920 MHz	25	32	—	dB	
	2775 to 2880 MHz	15	18	—	dB		
Inband VSWR (Return Loss)	925 to 960 MHz	— (7.4)	2.1 (9.0)	2.5 —	— (dB)		
Max. Input Power	925 to 960 MHz	—	—	23	dBm		
Filter 2	Insertion Loss	1805 to 1880 MHz	—	—	3.2	dB	+20 to +30 °C
			—	2.7	3.7	dB	-30 to +85 °C
	Inband Ripple	1805 to 1880 MHz	—	1.1	2.1	dB	
	Absolute Attenuation	DC to 1300 MHz	17	18	—	dB	
		1355 to 1430 MHz	18	20	—	dB	
		1500 to 1710 MHz	20	22	—	dB	
		1710 to 1785 MHz	17	—	—	dB	+20 to +30 °C
			8	25	—	dB	-30 to +85 °C
		1920 to 1980 MHz	15	29	—	dB	
		3610 to 3760 MHz	15	17	—	dB	
5415 to 5640 MHz	12	17	—	dB			
Inband VSWR (Return Loss)	1805 to 1880 MHz	— (7.7)	2.0 (9.5)	2.4 —	— (dB)		
Max. Input Power	1805 to 1880 MHz	—	—	13	dBm		

G5/G6 Series

8. EGSM Rx + PCN Rx (2 in/2 out) Part number : FAR-G6CH-1G8425-L222

(Ta = -30 °C to +85 °C)

Parameter	Condition	Value			Unit	Remarks	
		Min.	Typ.	Max.			
Filter 1	Insertion Loss	925 to 960 MHz	—	3.6	4.8	dB	
	Inband Ripple	925 to 960 MHz	—	1.6	2.8	dB	
	Absolute Attenuation	DC to 800 MHz	40	50	—	dB	
		880 to 915 MHz	15	22	—	dB	
		980 to 1030 MHz	25	31	—	dB	
		1375 to 1410 MHz	40	46	—	dB	
		1850 to 1920 MHz	30	44	—	dB	
	Inband VSWR (Return Loss)	925 to 960 MHz	— (6.5)	2.3 (8.1)	2.8 —	— (dB)	
Max. Input Power	925 to 960 MHz	—	—	15	dBm		
Filter 2	Insertion Loss	1805 to 1880 MHz	—	3.4	4.5	dB	
	Inband Ripple	1805 to 1880 MHz	—	1.8	2.9	dB	
	Absolute Attenuation	DC to 1300 MHz	20	22	—	dB	
		1355 to 1430 MHz	21	23	—	dB	
		1500 to 1710 MHz	22	25	—	dB	
		1710 to 1785 MHz	10	23	—	dB	
		1920 to 1980 MHz	25	34	—	dB	
		3610 to 3760 MHz	20	36	—	dB	
	Inband VSWR (Return Loss)	1805 to 1880 MHz	— (6.5)	2.3 (8.1)	2.8 —	— (dB)	
Max. Input Power	1805 to 1880 MHz	—	—	13	dBm		

9. EGSM Rx + PCN Rx (2 in/2 out)
Part number : FAR-G6CH-1G8425-L227B

(Ta = -30 °C to +85 °C)

Parameter		Condition	Value			Unit	Remarks
			Min.	Typ.	Max.		
Filter 1	Insertion Loss	925 to 960 MHz	—	—	3.0	dB	+20 to +30 °C
			—	2.7	3.7	dB	-30 to +85 °C
	Inband Ripple	925 to 960 MHz	—	1.1	2.1	dB	
	Absolute Attenuation	DC to 880 MHz	22	23	—	dB	
		880 to 905 MHz	28	32	—	dB	
		905 to 915 MHz	11	32	—	dB	-30 to +30 °C
			7	—	—	dB	+30 to +85 °C
		980 to 1200 MHz	20	30	—	dB	
		1375 to 1410 MHz	30	38	—	dB	
	1850 to 1920 MHz	20	26	—	dB		
Inband VSWR (Return Loss)	925 to 960 MHz	— (7.7)	1.9 (10.2)	2.4 —	— (dB)		
Max. Input Power	925 to 960 MHz	—	—	23	dBm		
Filter 2	Insertion Loss	1805 to 1880 MHz	—	—	3.5	dB	+20 to +30 °C
			—	2.8	3.9	dB	-30 to +85 °C
	Inband Ripple	1805 to 1880 MHz	—	1.3	2.4	dB	
	Absolute Attenuation	DC to 1300 MHz	17	18	—	dB	
		1355 to 1430 MHz	17	19	—	dB	
		1600 to 1710 MHz	20	22	—	dB	
		1710 to 1785 MHz	20	25	—	dB	-30 to +30 °C
			10	—	—	dB	+30 to +85 °C
		1920 to 1980 MHz	20	29	—	dB	
	3610 to 3760 MHz	15	19	—	dB		
Inband VSWR (Return Loss)	1805 to 1880 MHz	— (7.7)	1.9 (10.2)	2.4 —	— (dB)		
Max. Input Power	1805 to 1880 MHz	—	—	13	dBm		

G5/G6 Series

10. EGSM Rx + PCN Rx (2 in/2 out) Part number : FAR-G6CH-1G9600-L228A

(Ta = -30 °C to +85 °C)

Parameter	Condition	Value			Unit	Remarks	
		Min.	Typ.	Max.			
Filter 1	Insertion Loss	925 to 960 MHz	—	—	3.0	dB	+20 to +30 °C
		—	—	2.7	3.7	dB	-30 to +85 °C
	Inband Ripple	925 to 960 MHz	—	1.1	2.1	dB	
	Absolute Attenuation	DC to 880 MHz	22	23	—	dB	
		880 to 905 MHz	28	32	—	dB	
		905 to 915 MHz	11	32	—	dB	-30 to +30 °C
			7	—	—	dB	+30 to +85 °C
		980 to 1200 MHz	20	—	—	dB	-30 to +20 °C
			25	32	—	dB	+20 to +85 °C
		1375 to 1410 MHz	30	38	—	dB	
1850 to 1920 MHz	20	26	—	dB			
Inband VSWR (Return Loss)	925 to 960 MHz	— (7.7)	1.9 (10.2)	2.4 —	— (dB)		
Max. Input Power	925 to 960 MHz	—	—	23	dBm		
Filter 2	Insertion Loss	1930 to 1990 MHz	—	—	3.9	dB	+20 to +30 °C
		—	—	3.5	4.2	dB	-30 to +85 °C
	Inband Ripple	1930 to 1990 MHz	—	1.9	2.6	dB	
	Absolute Attenuation	DC to 1850 MHz	20	22	—	dB	
		1850 to 1910 MHz	7	10	—	dB	-30 to +30 °C
			5	—	—	dB	+30 to +85 °C
		2010 to 2100 MHz	5	—	—	dB	-30 to +20 °C
			6	10	—	dB	+20 to +85 °C
		2500 to 2700 MHz	20	25	—	dB	
	3000 to 4000 MHz	15	18	—	dB		
Inband VSWR (Return Loss)	1930 to 1990 MHz	— (7.0)	2.1 (9.0)	2.6 —	— (dB)		
Max. Input Power	1930 to 1990 MHz	—	—	13	dBm		

11. PCN Rx + PCS Rx (2 in/2 out)
Part number : FAR-G6CH-1G9600-L219

(Ta = -30 °C to +85 °C)

Parameter	Condition	Value			Unit	Remarks	
		Min.	Typ.	Max.			
Filter 1	Insertion Loss	1805 to 1880 MHz	—	3.1	4.0	dB	
	Inband Ripple	1805 to 1880 MHz	—	1.4	2.3	dB	
	Absolute Attenuation	DC to 1500 MHz	17	18	—	dB	
		1600 to 1710 MHz	22	25	—	dB	
		1710 to 1785 MHz	10	24	—	dB	
		1920 to 1980 MHz	20	30	—	dB	
		2000 to 2400 MHz	25	27	—	dB	
	3610 to 3760 MHz	16	18	—	dB		
	5415 to 5640 MHz	14	16	—	dB		
Inband VSWR (Return Loss)	1805 to 1880 MHz	— (7.7)	2.0 (9.5)	2.4 —	— (dB)		
Max. Input Power	1805 to 1880 MHz	—	—	13	dBm		
Filter 2	Insertion Loss	1930 to 1990 MHz	—	3.1	4.3	dB	
	Inband Ripple	1930 to 1990 MHz	—	1.2	2.4	dB	
	Absolute Attenuation	DC to 1500 MHz	21	23	—	dB	
		1500 to 1850 MHz	22	25	—	dB	
		1850 to 1910 MHz	8	23	—	dB	
		2040 to 2200 MHz	25	28	—	dB	
		2500 to 3000 MHz	19	21	—	dB	
		3860 to 3980 MHz	16	19	—	dB	
	5790 to 5970 MHz	8	11	—	dB		
Inband VSWR (Return Loss)	1930 to 1990 MHz	— (8.1)	1.5 (14.0)	2.3 —	— (dB)		
Max. Input Power	1930 to 1990 MHz	—	—	13	dBm		

G5/G6 Series

12. PCS Tx split band (low band + high band dual) (2 in/2 out)

Part number : FAR-G6CN-1G8950-L233

(Ta = -30 °C to +85 °C)

Parameter	Condition	Value			Unit	Remarks	
		Min.	Typ.	Max.			
Filter 1	Insertion Loss	1850 to 1880 MHz	—	2.1	3.2	dB	
	Inband Ripple	1850 to 1880 MHz	—	0.4	1.5	dB	
	Absolute Attenuation	DC to 1700 MHz	20	23	—	dB	
		1700 to 1760 MHz	28	38	—	dB	
		1930 to 1960 MHz	30	38	—	dB	
		2000 to 2100 MHz	30	35	—	dB	
	2100 to 3000 MHz	25	35	—	dB		
	Inband VSWR (Return Loss)	1850 to 1880 MHz	— (8.5)	1.4 (15.6)	2.2 —	— (dB)	
Max. Input Power	1850 to 1880 MHz	—	—	13	dBm		
Filter 2	Insertion Loss	1880 to 1910 MHz	—	2.4	3.2	dB	
	Inband Ripple	1880 to 1910 MHz	—	0.6	1.5	dB	
	Absolute Attenuation	DC to 1700 MHz	21	24	—	dB	
		1700 to 1760 MHz	28	37	—	dB	
		1800 to 1830 MHz	15	26	—	dB	
		1960 to 1990 MHz	30	37	—	dB	
	2000 to 2100 MHz	30	38	—	dB		
	2100 to 3000 MHz	25	32	—	dB		
Inband VSWR (Return Loss)	1880 to 1910 MHz	— (8.5)	1.5 (14.0)	2.2 —	— (dB)		
Max. Input Power	1880 to 1910 MHz	—	—	13	dBm		

13. PCS Rx split band (low band + high band dual) (2 in/2 out)
Part number : FAR-G6CH-1G9750-L230

(Ta = -30 °C to +85 °C)

Parameter	Condition	Value			Unit	Remarks	
		Min.	Typ.	Max.			
Filter 1	Insertion Loss	1930 to 1960 MHz	—	2.4	3.2	dB	
	Inband Ripple	1930 to 1960 MHz	—	0.6	1.4	dB	
	Absolute Attenuation	DC to 1850 MHz	20	21	—	dB	
		1850 to 1880 MHz	30	36	—	dB	
		2040 to 2070 MHz	20	30	—	dB	
		2500 to 3000 MHz	20	32	—	dB	
	Inband VSWR (Return Loss)	1930 to 1960 MHz	— (9.0)	1.7 (11.7)	2.1 —	— (dB)	
Max. Input Power	1930 to 1960 MHz	—	—	13	dBm		
Filter 2	Insertion Loss	1960 to 1990 MHz	—	2.3	3.2	dB	
	Inband Ripple	1960 to 1990 MHz	—	0.5	1.4	dB	
	Absolute Attenuation	DC to 1880 MHz	20	21	—	dB	
		1880 to 1910 MHz	30	40	—	dB	
		2070 to 2100 MHz	20	31	—	dB	
		2500 to 3000 MHz	20	31	—	dB	
	Inband VSWR (Return Loss)	1960 to 1990 MHz	— (9.0)	1.7 (11.7)	2.1 —	— (dB)	
Max. Input Power	1960 to 1990 MHz	—	—	13	dBm		

G5/G6 Series

TYPICAL CHARACTERISTICS

1. PDC800 (Tx) 1 in/2 out

Part number : FAR-G5CN-942M50-D296

Filter 1 (Passband : 893 to 898 MHz)

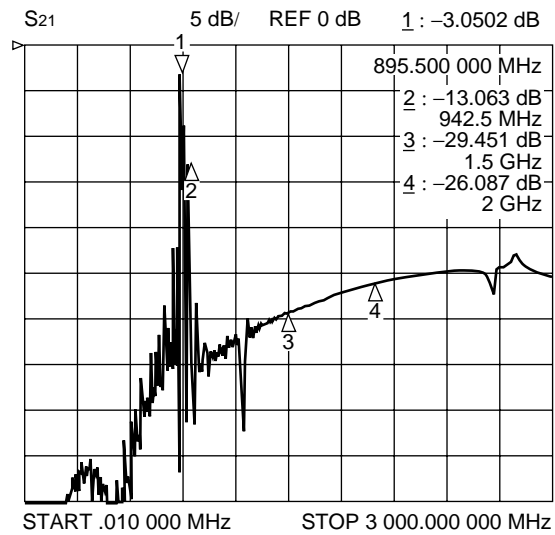
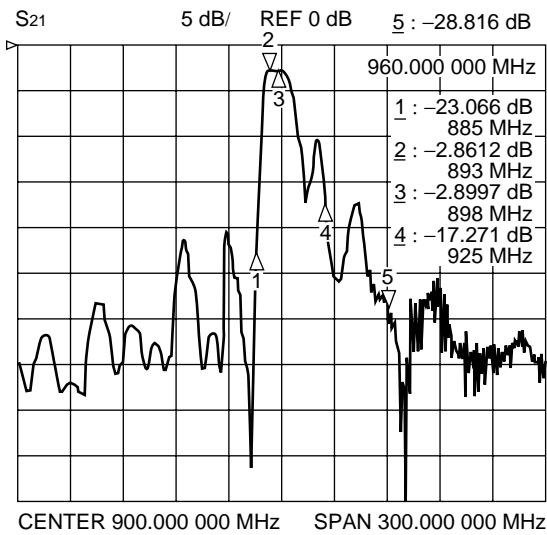

Filter 2 (Passband : 925 to 960 MHz)

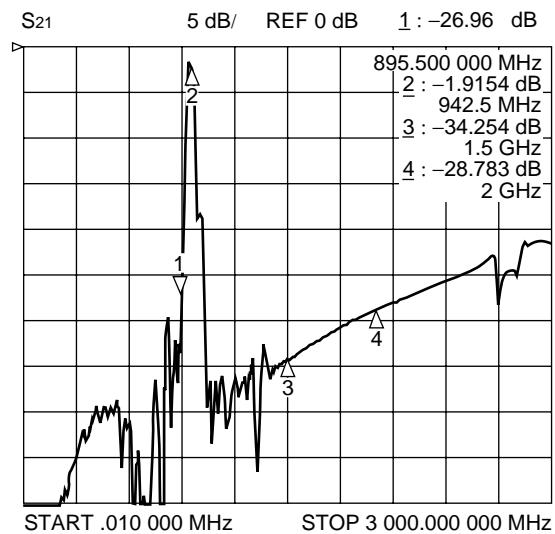
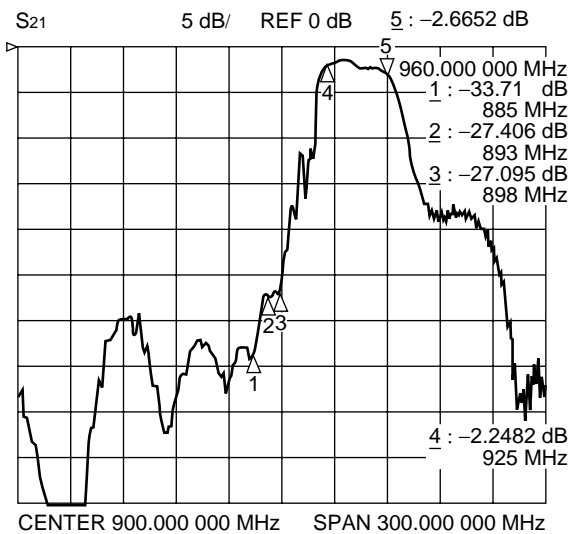

2. PDC800 (Rx) 1 in/2 out
Part number : FAR-G5CN-877M50-D292

Filter 1 (Passband : 810 to 843 MHz)

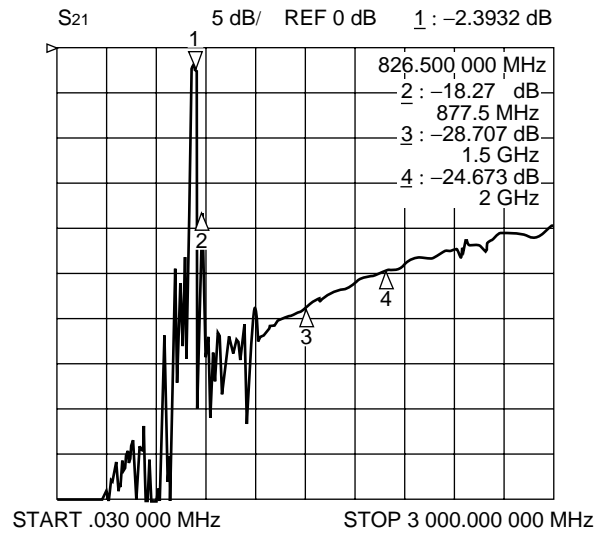
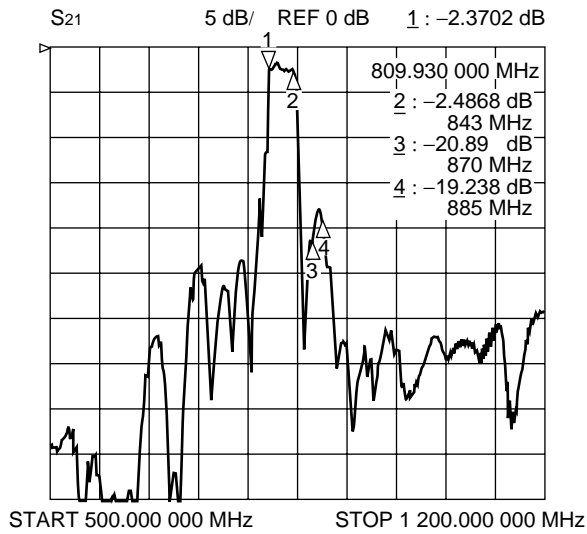

Filter 2 (Passband : 870 to 885 MHz)

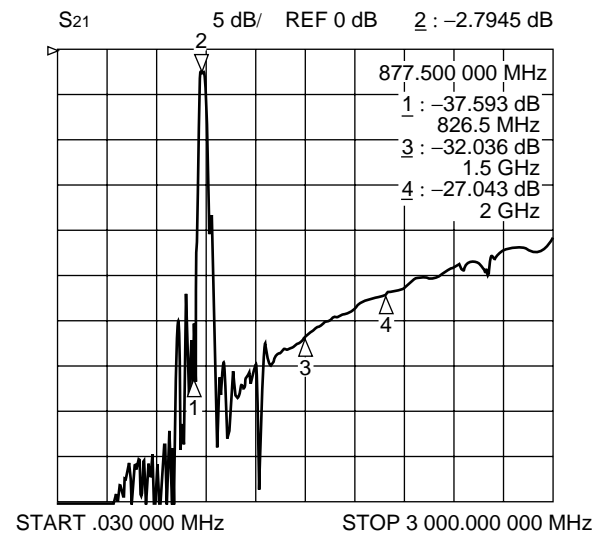
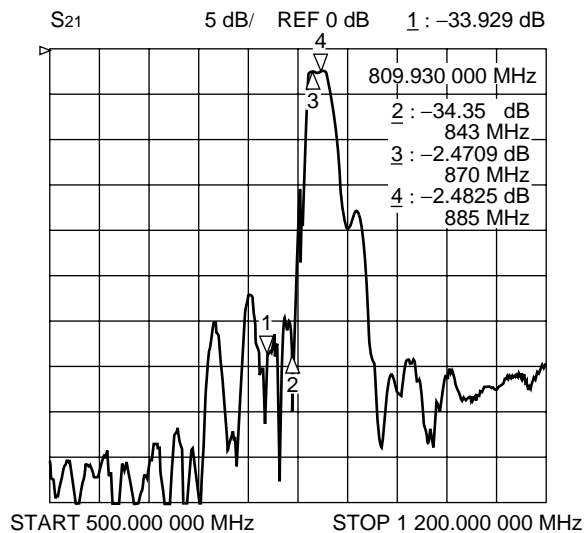

G5/G6 Series

3. AMPS/TDMA/CDMA Tx + PCS Tx (2 in/2 out) Part number : FAR-G6CH-1G8800-L214

Filter 1 (Passband : 824 to 849 MHz)

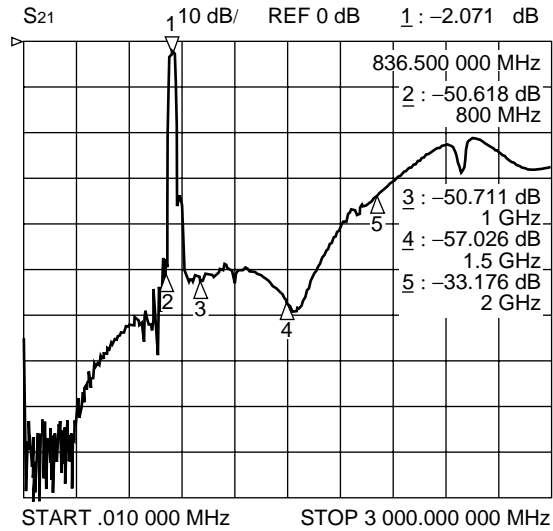
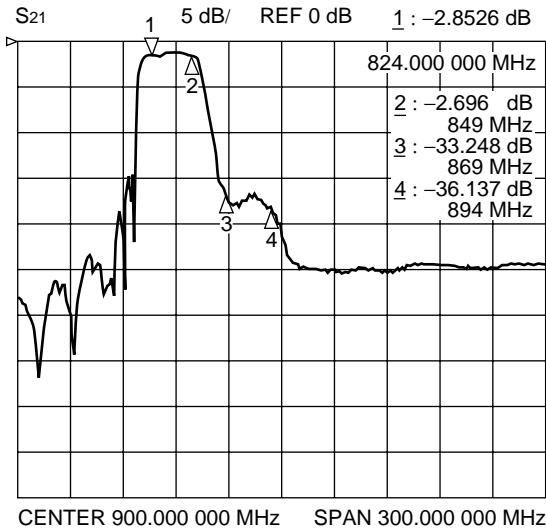

Filter 2 (Passband : 1850 to 1910 MHz)

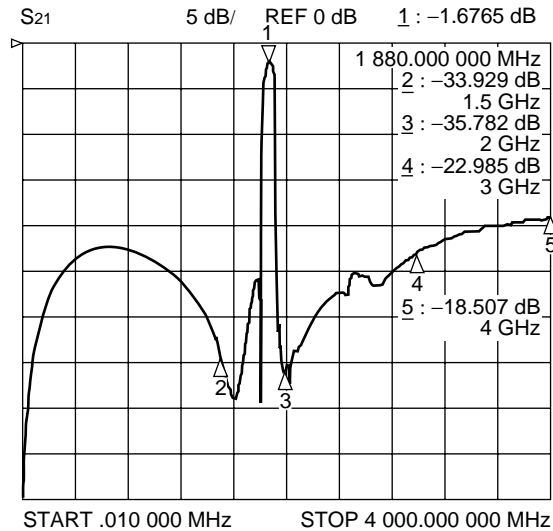
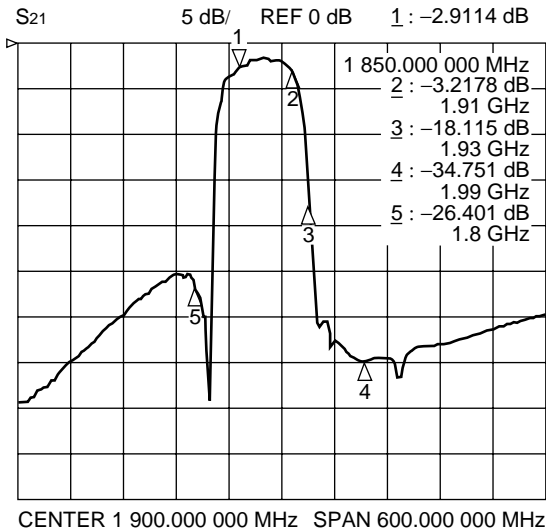

4. AMPS/TDMA/CDMA Rx + PCS Rx (2 in/2 out) Part number : FAR-G6CH-1G9600-L215

Filter 1 (Passband : 869 to 894 MHz)

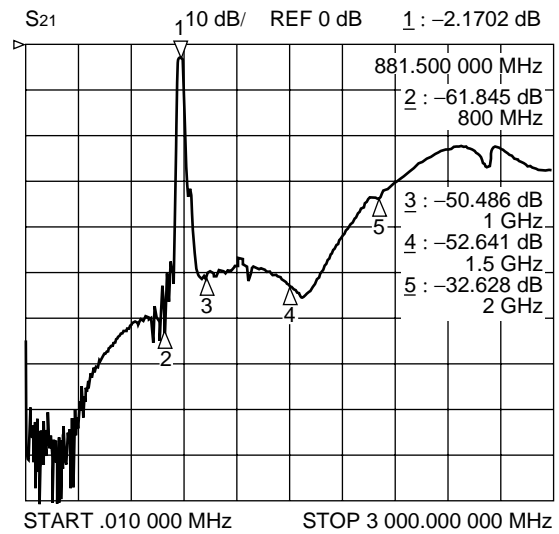
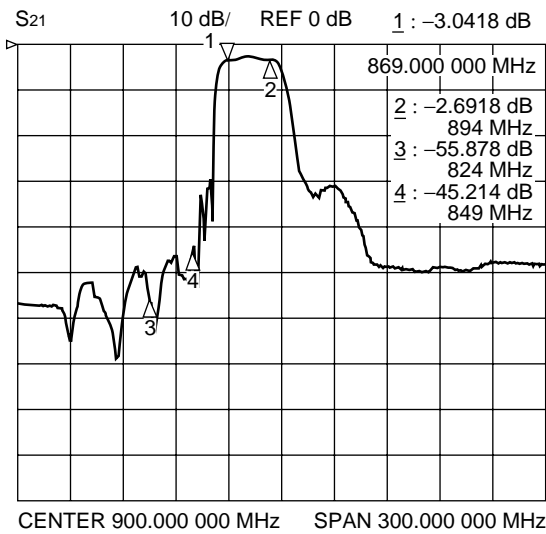

Filter 2 (Passband : 1930 to 1960 MHz)

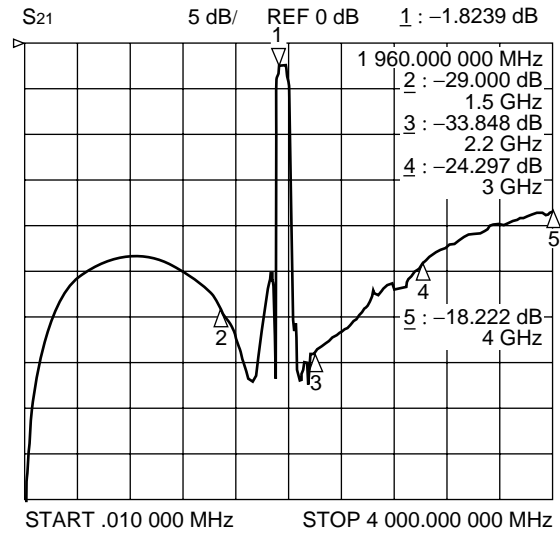
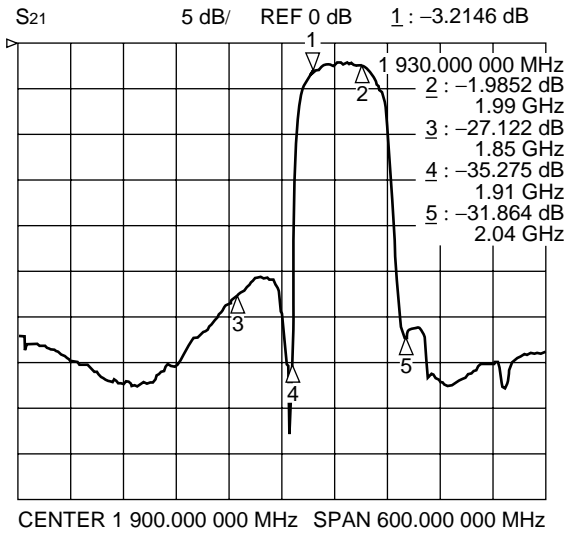

G5/G6 Series

5. GSM Tx + PCN Tx (2 in/2 out) Part number : FAR-G6CH-1G7475-L216

Filter 1 (Passband : 890 to 915 MHz)

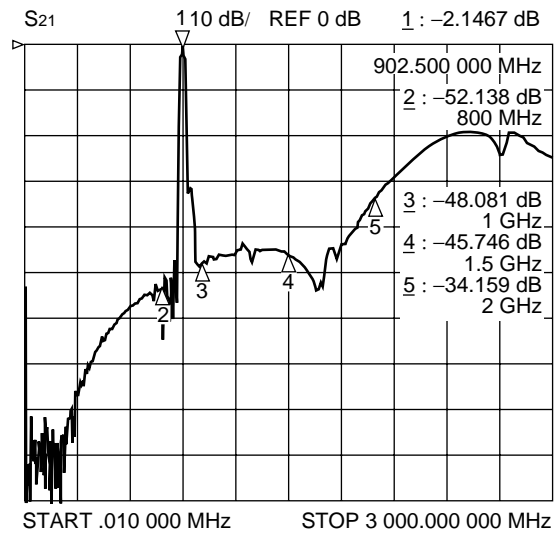
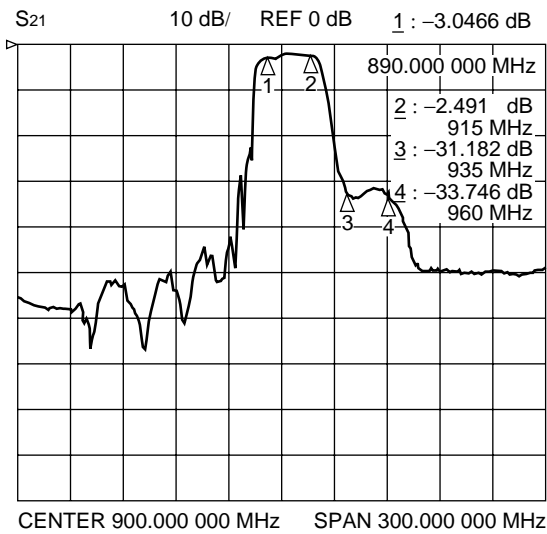

Filter 2 (Passband : 1710 to 1785 MHz)

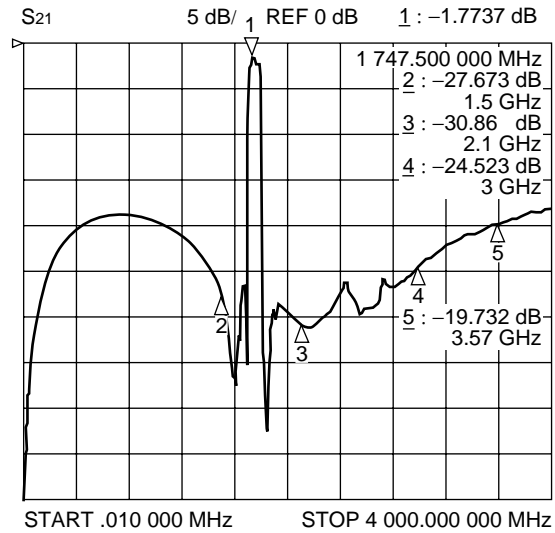
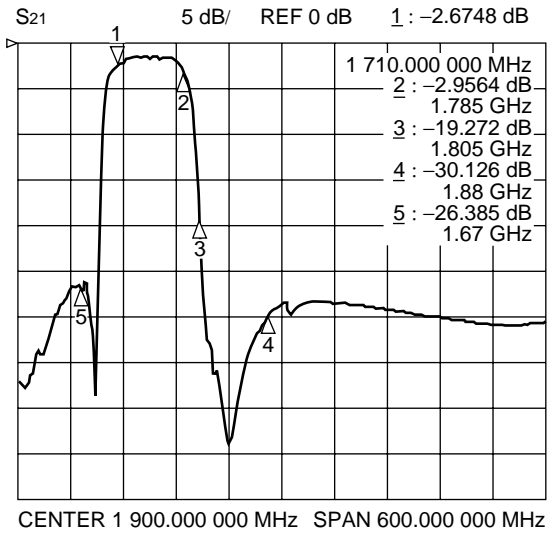

6. GSM Rx + PCN Rx (2 in/2 out) Part number : FAR-G6CH-1G8425-L217

Filter 1 (Passband : 935 to 960 MHz)

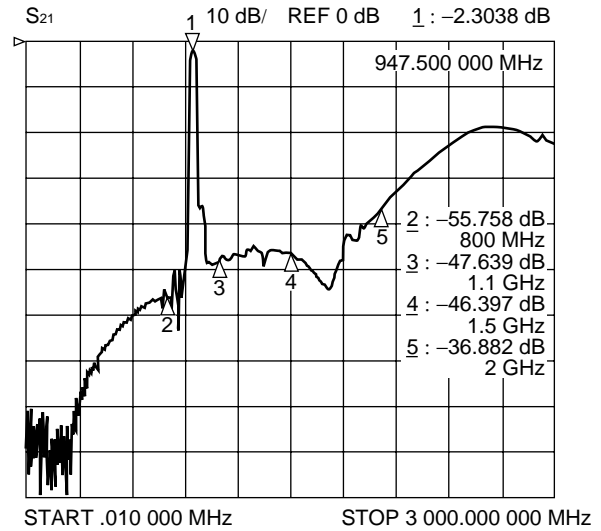
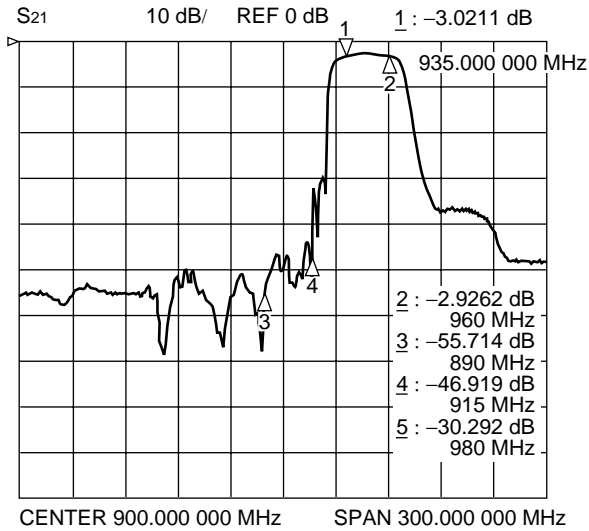

Filter 2 (Passband : 1805 to 1880 MHz)

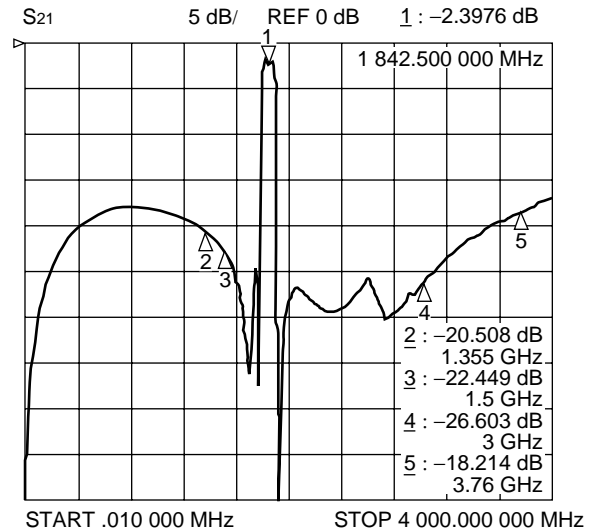
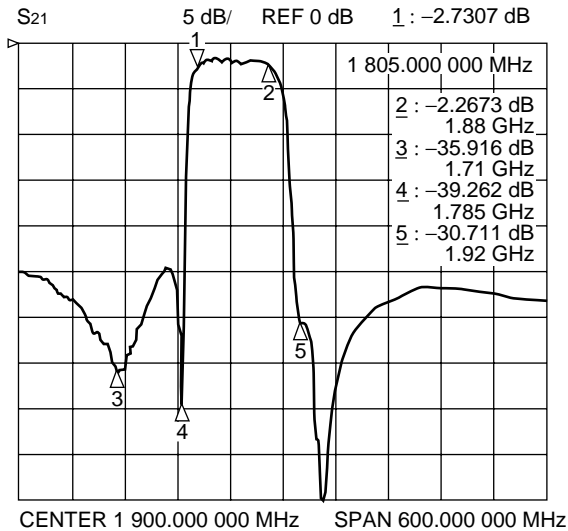

G5/G6 Series

7. EGSM Rx + PCN Rx (2 in/2 out) Part number : FAR-G6CH-1G8425-L218

Filter 1 (Passband : 925 to 960 MHz)

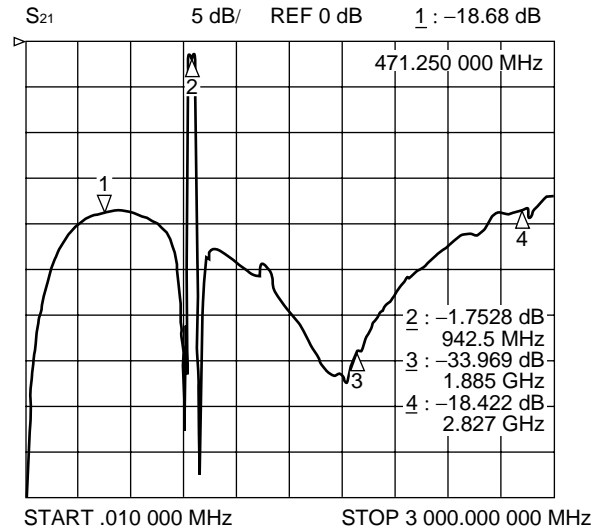
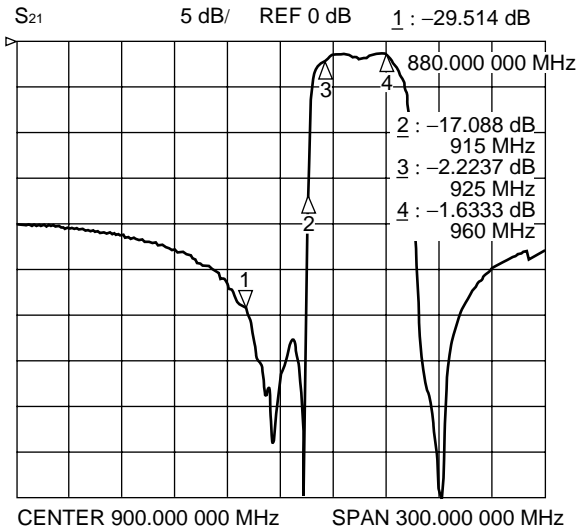

Filter 2 (Passband : 1805 to 1880 MHz)

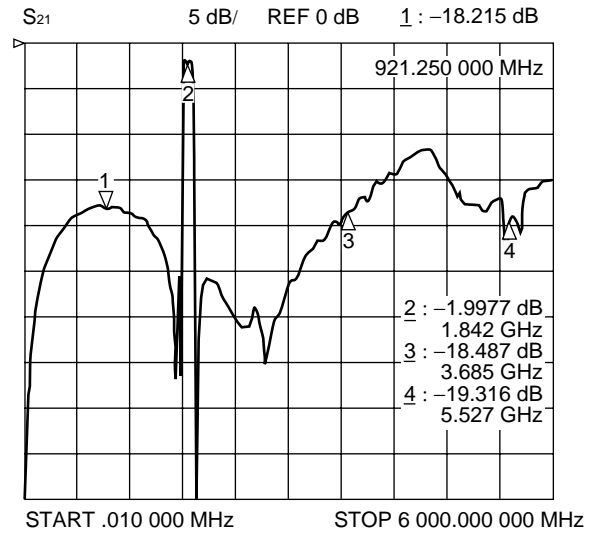
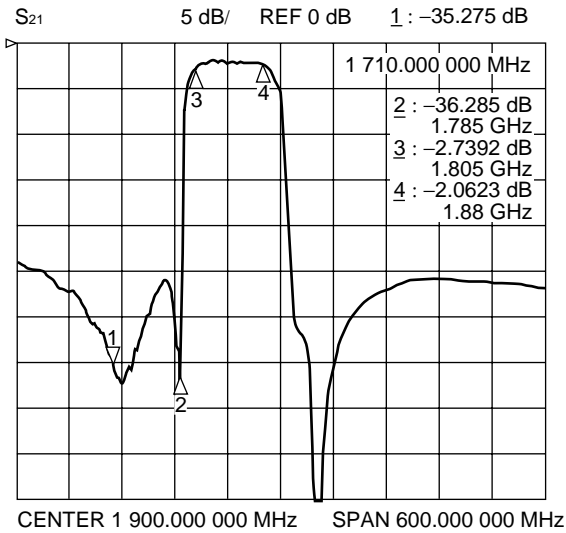

8. EGSM Rx + PCN Rx (2 in/2 out) Part number : FAR-G6CH-1G8425-L222

Filter 1 (Passband : 925 to 960 MHz)

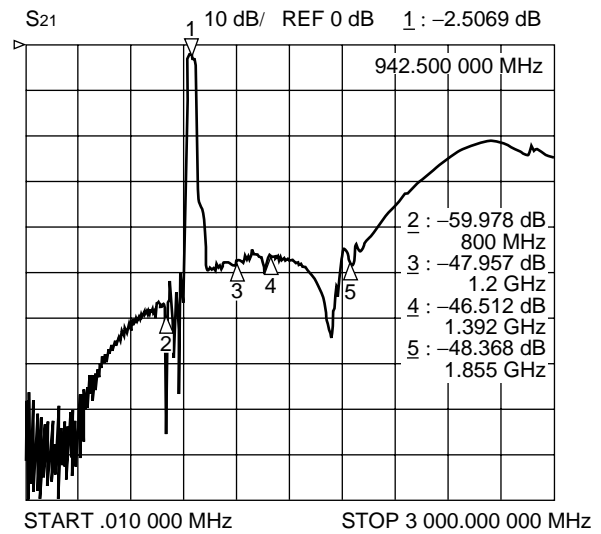
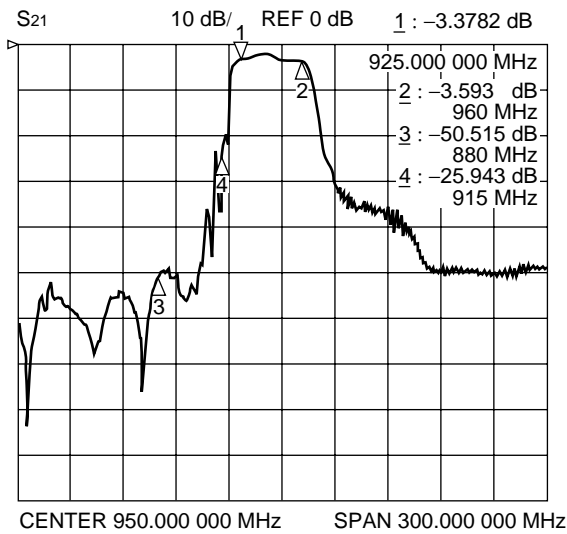

Filter 2 (Passband : 1805 to 1880 MHz)

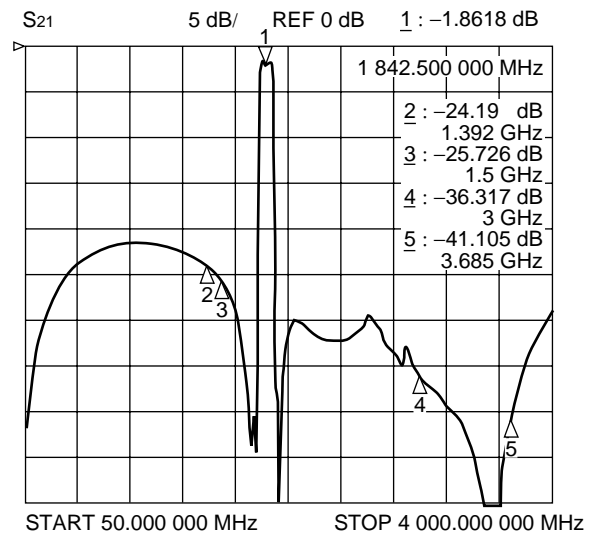
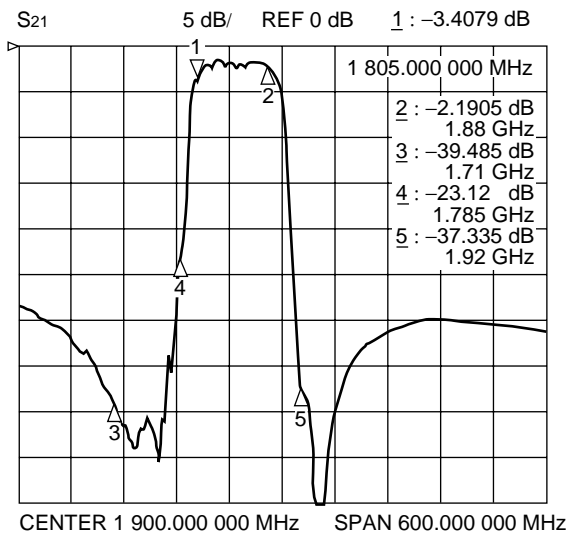

G5/G6 Series

9. EGSM Rx + PCN Rx (2 in/2 out) Part number : FAR-G6CH-1G8425-L227B

Filter 1 (Passband : 925 to 960 MHz)

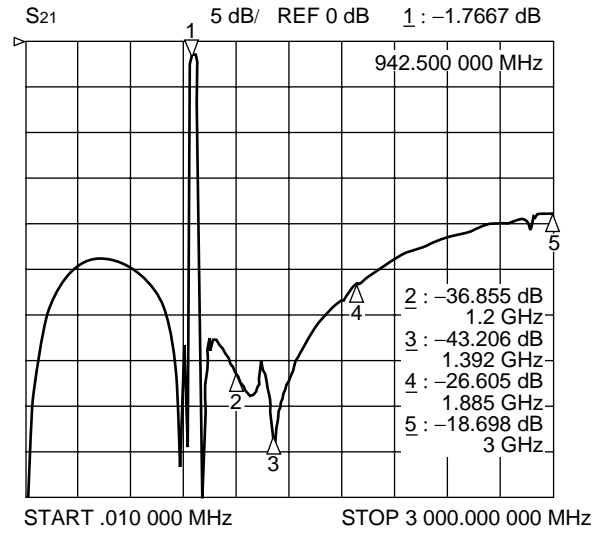
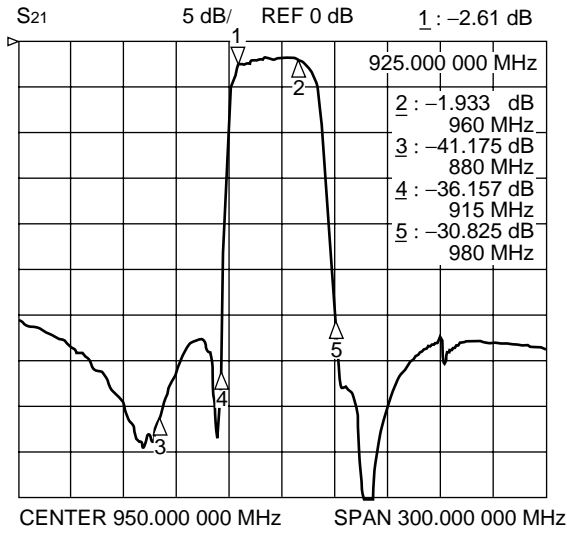

Filter 2 (Passband : 1805 to 1880 MHz)

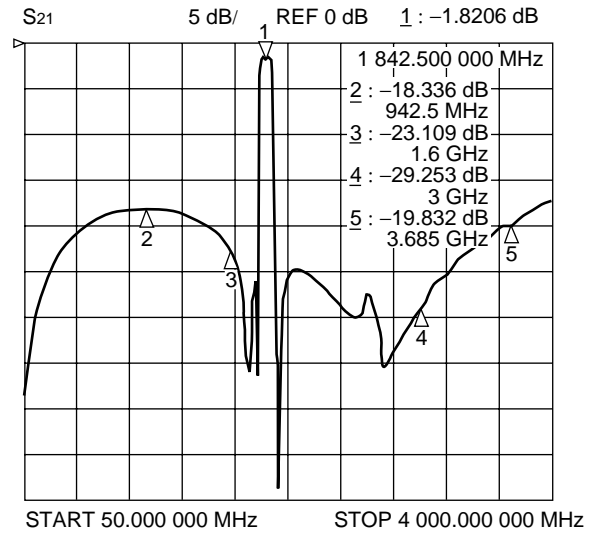
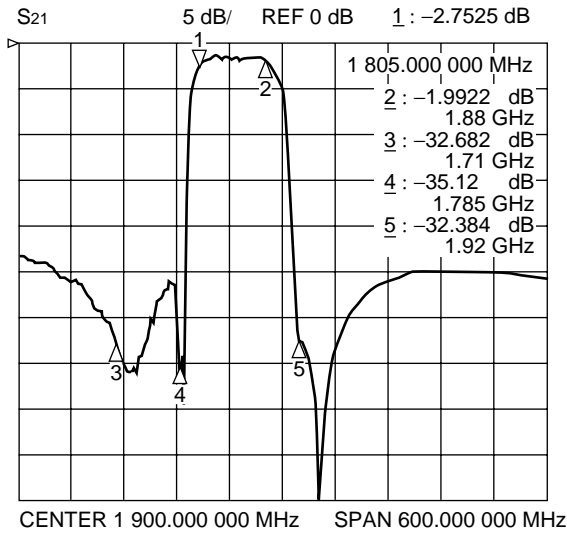

10. EGSM Rx + PCN Rx (2 in/2 out)
Part number : FAR-G6CH-1G9600-L228A

Filter 1 (Passband : 925 to 960 MHz)

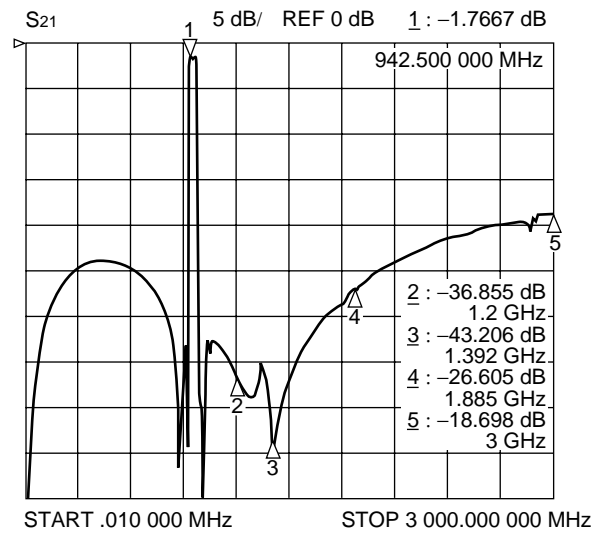
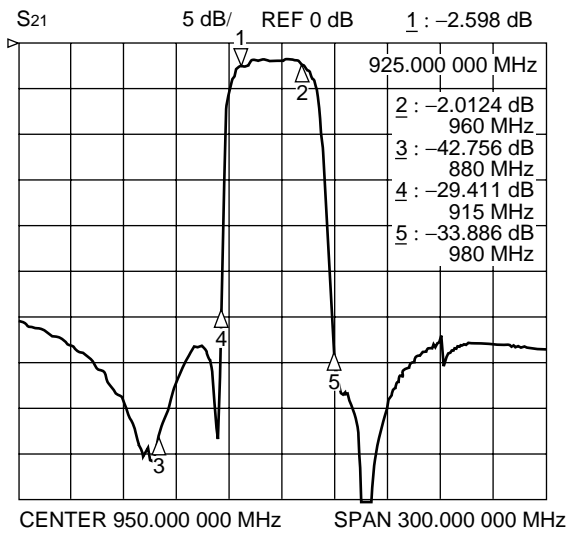

Filter 2 (Passband : 1930 to 1990 MHz)

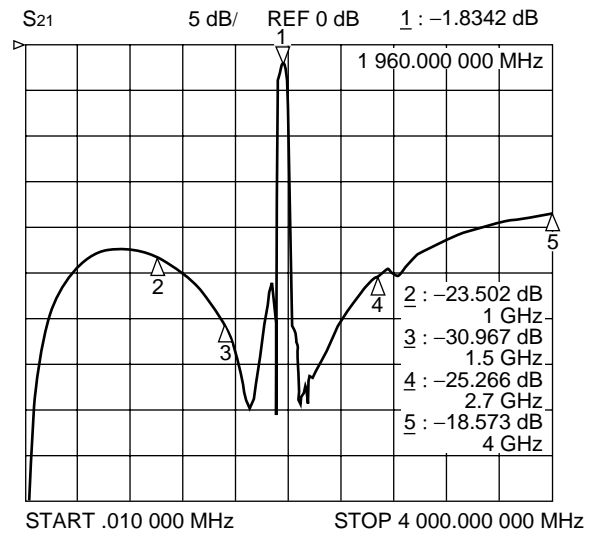
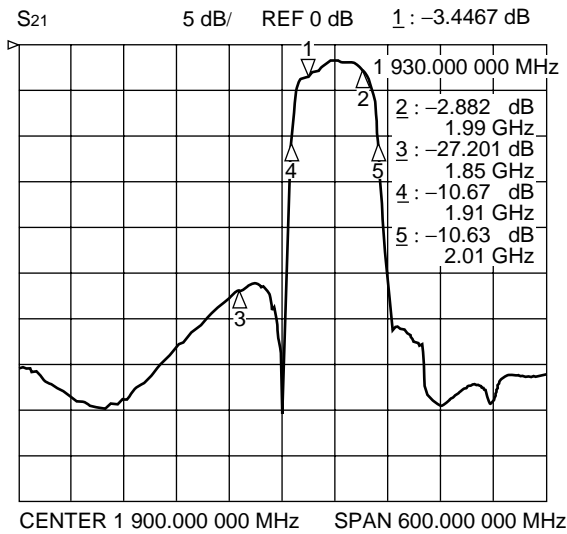

G5/G6 Series

11. PCN Rx + PCS Rx (2 in/2 out) Part number : FAR-G6CH-1G9600-L219

Filter 1 (Passband : 1805 to 1880 MHz)

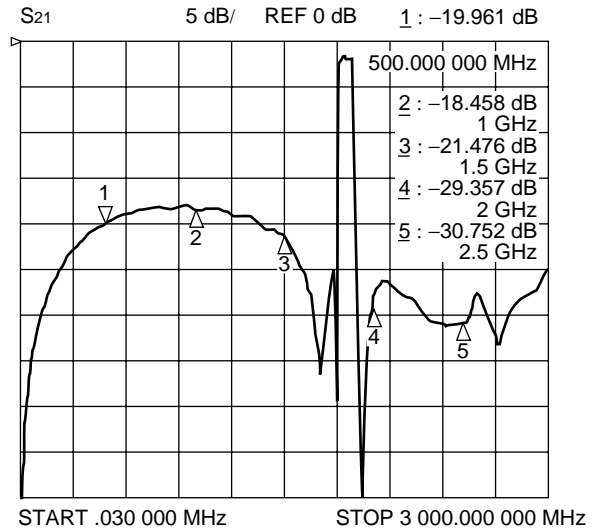
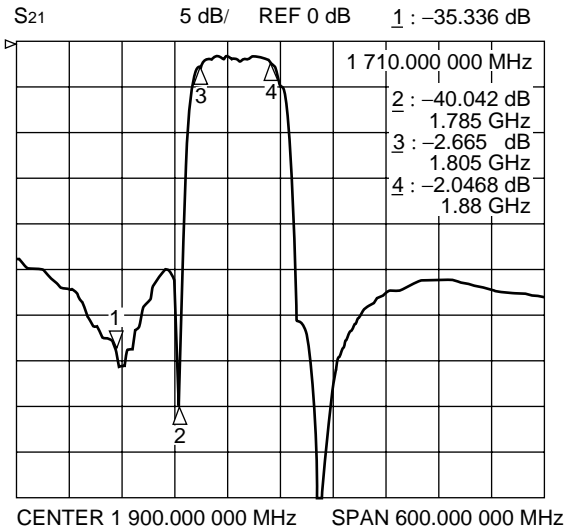

Filter 2 (Passband : 1930 to 1990 MHz)

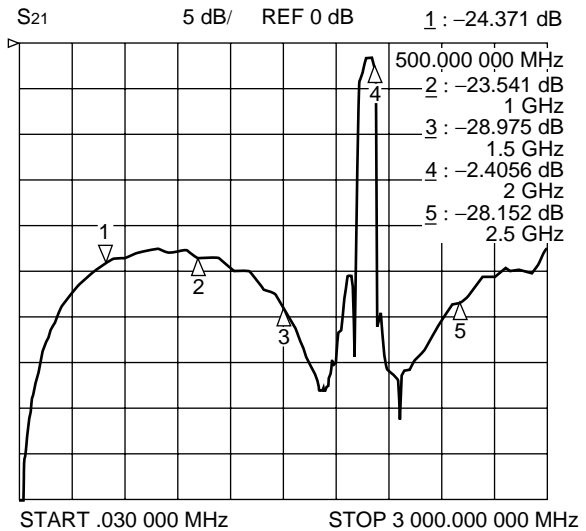
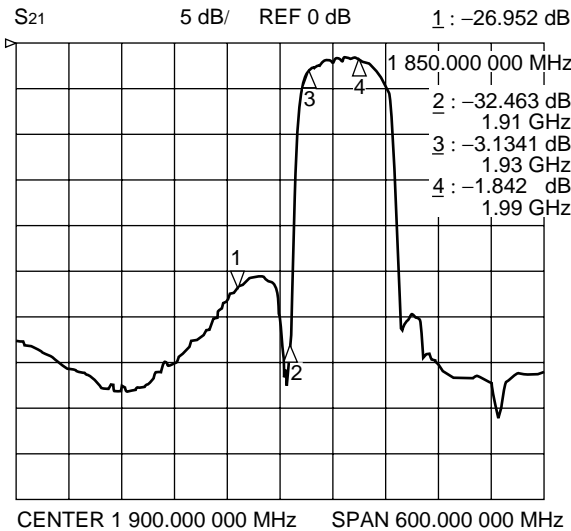

12. PCS Tx split band (low band + high band dual) (2 in/2 out) Part number : FAR-G6CN-1G8950-L233

Filter 1 (Passband : 1850 to 1880 MHz)

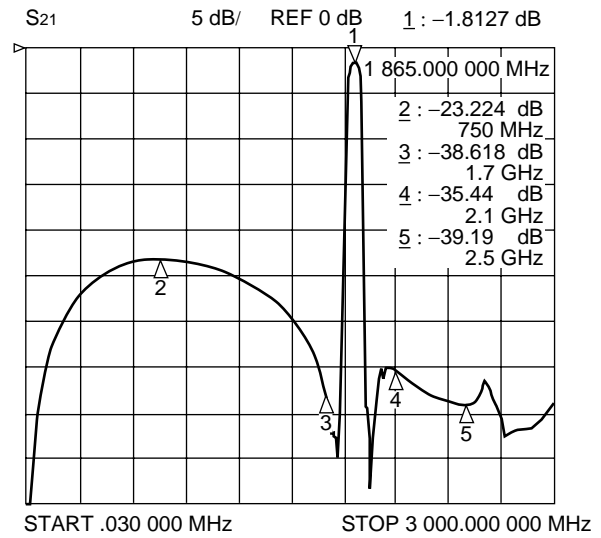
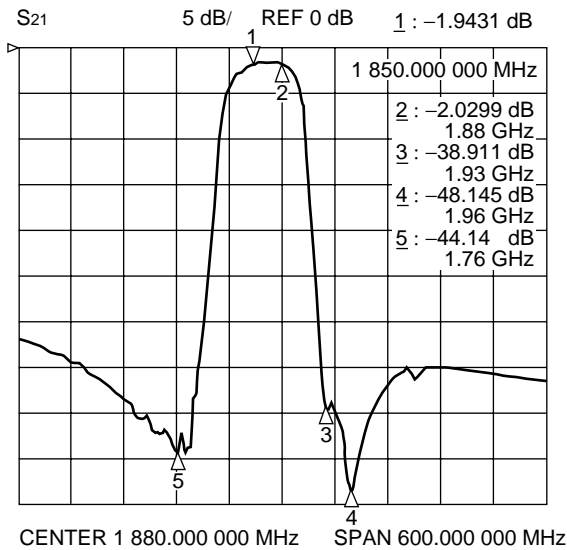

Filter 2 (Passband : 1930 to 1990 MHz)

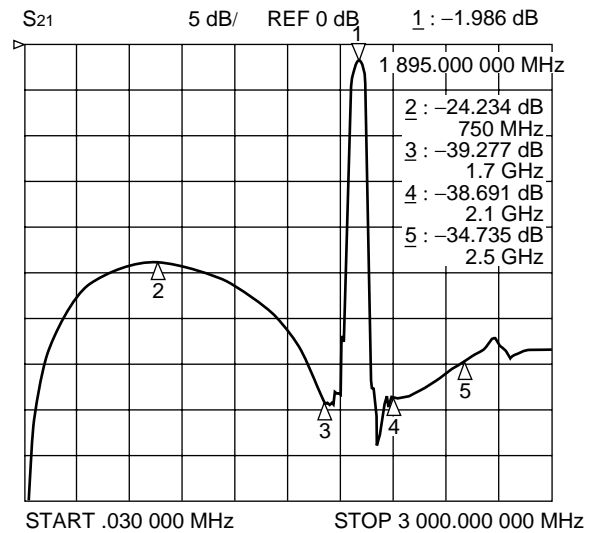
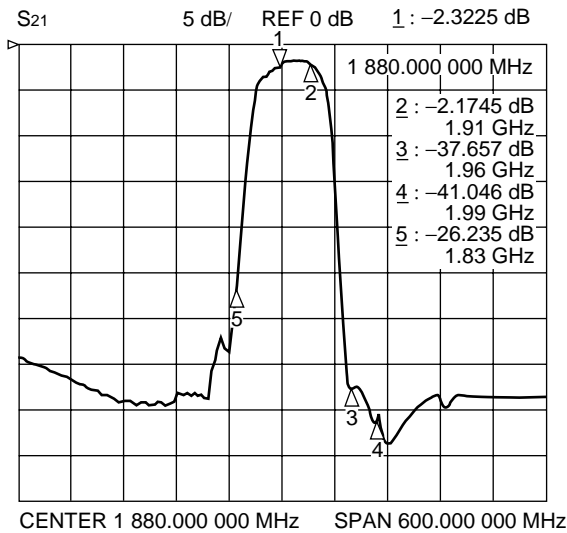

G5/G6 Series

13. PCS Rx split band (low band + high band dual) (2 in/2 out) Part number : FAR-G6CH-1G9750-L230

Filter 1 (Passband : 1930 to 1960 MHz)

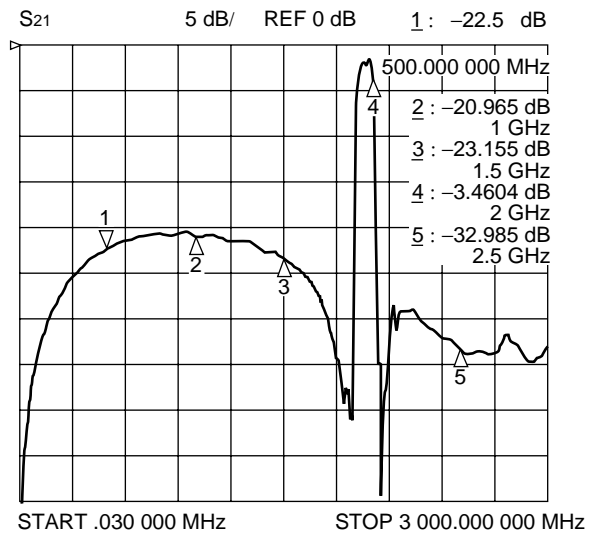
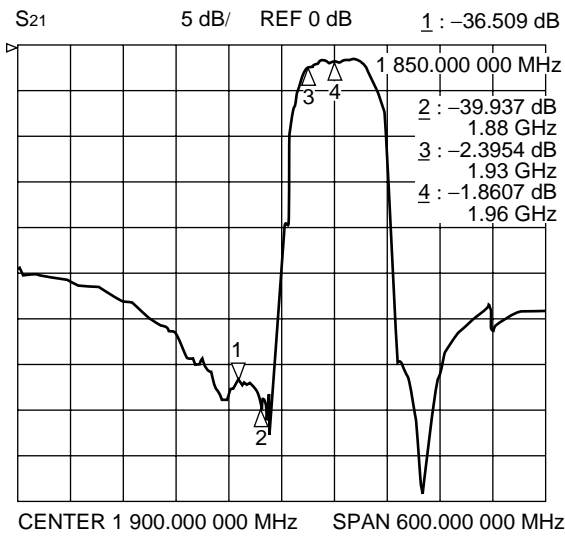

Filter 2 (Passband : 1960 to 1990 MHz)

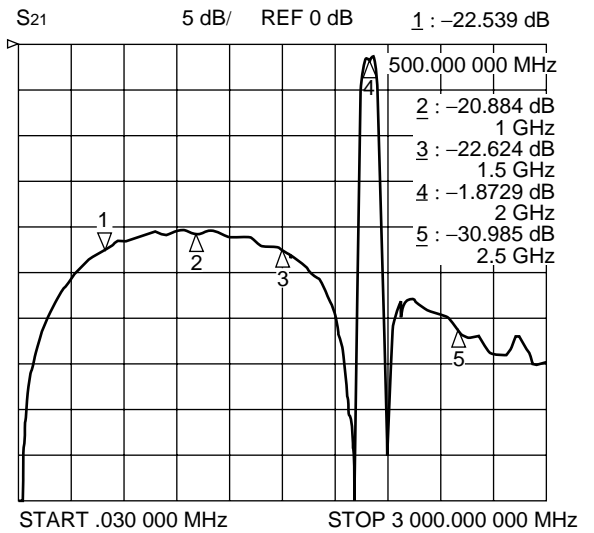
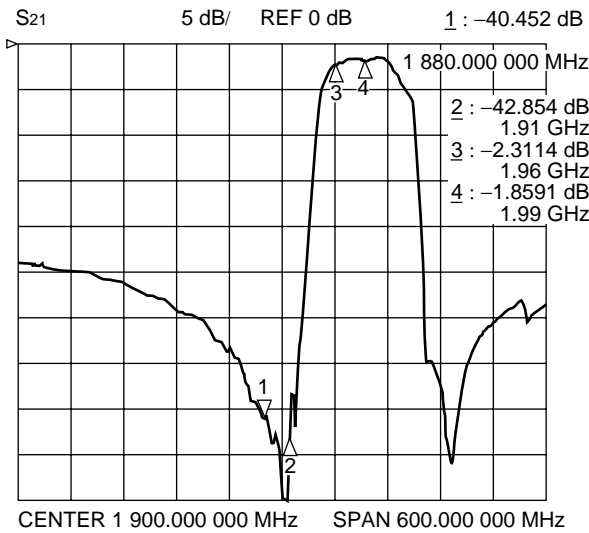

MEASUREMENT CIRCUIT

1 in/2 out type (G5CN filters)

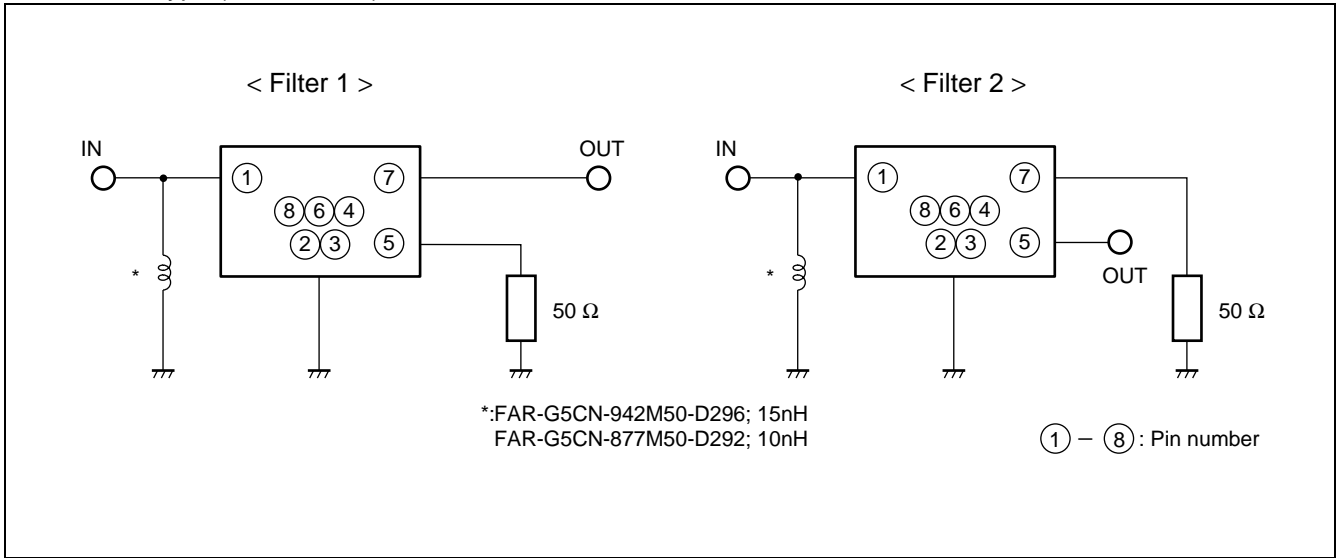

2 in/2 out type (G6CH filters)

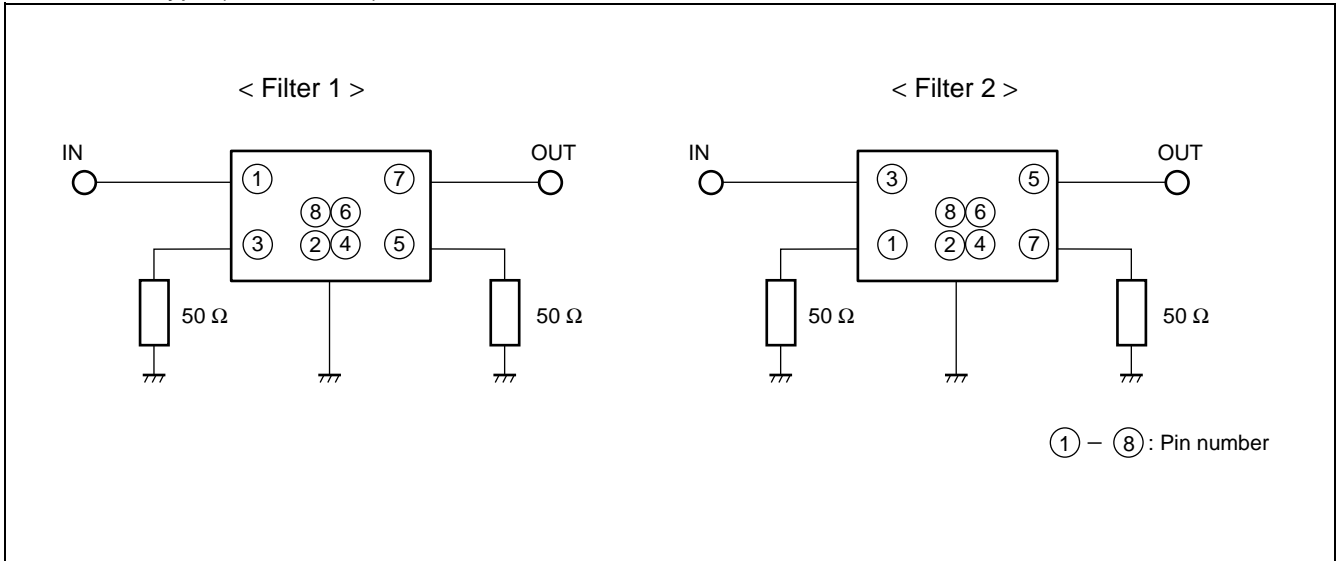

G5/G6 Series

RECOMMENDED EXTERNAL CIRCUIT OF 1 IN/2 OUT TYPE

(G5CN filters)

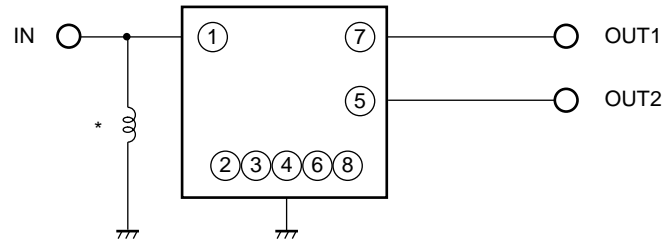

*: FAR-G5CN-942M50-D296; 15nH
FAR-G5CN-877M50-D292; 10nH

MARKING

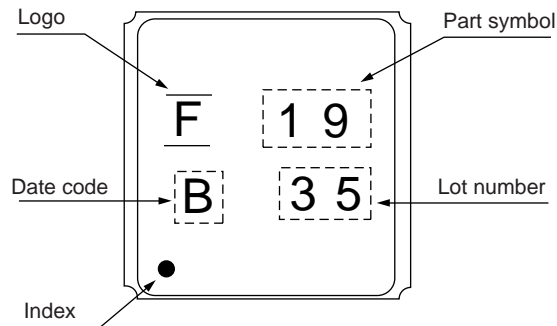

■ PART NUMBER DESIGNATION

[Designation example]

< G5CN FILTER >

FAR-G5CN-□□□□□□ -D2 □□ - □
 (1) (2) (3)

- (1) Frequency : This specifies the nominal center frequency of higher frequency side using six alphanumeric.
 M (for MHz) indicates the decimal point.
 [Example] 877M50 ⇒ 877.5 MHz
- (2) Part symbol : 01 to 99 (Numbers specified by Fujitsu)
- (4) Packing : W; 1 k pcs/reel
 V ; 3 k pcs/reel
 U ; 5 k pcs/reel

< G6CH FILTER >

FAR-G6CH-□□□□□□ -L2 □□ - □
 (1) (2) (3)

- (1) Frequency : This specifies the nominal center frequency of higher frequency side using six alphanumeric.
 G (for GHz) indicates the decimal point.
 [Example] 1G8800 ⇒ 1.88 GHz
- (2) Part symbol : 01 to 99 (Numbers specified by Fujitsu)
- (4) Packing : T; 1 k pcs/reel
 R; 3 k pcs/reel

< G6CN FILTER >

FAR-G6CN-□□□□□□ -L2 □□ - □
 (1) (2) (3)

- (1) Frequency : This specifies the nominal center frequency of higher frequency side using six alphanumeric.
 G (for GHz) indicates the decimal point.
 [Example] 1G8950 ⇒ 1.895 GHz
- (2) Part symbol : 01 to 99 (Numbers specified by Fujitsu)
- (4) Packing : W; 1 k pcs/reel
 V ; 3 k pcs/reel
 U ; 5 k pcs/reel

G5/G6 Series

PACKAGE DIMENSIONS

< G5CN package >
< G6CN package >

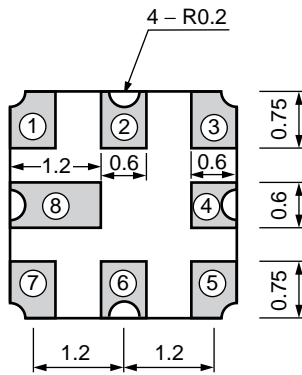
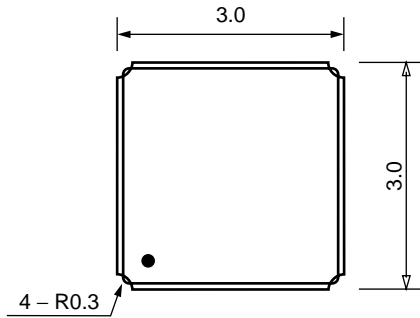

< G6CH package >

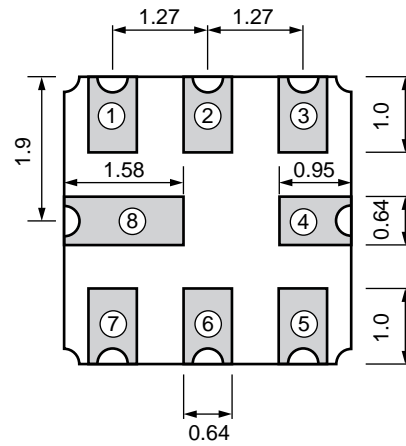
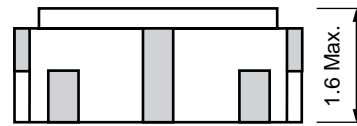
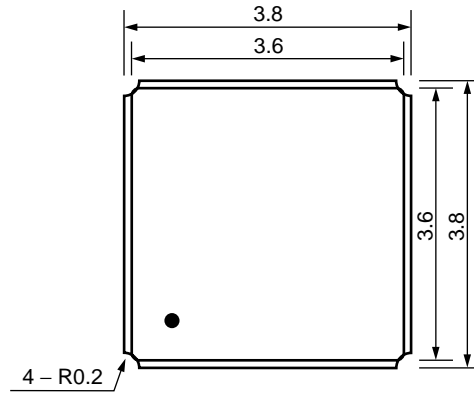

Dimensions in mm.

RECOMMENDED LAND PATTERN

< G5CN package >
< G6CN package >

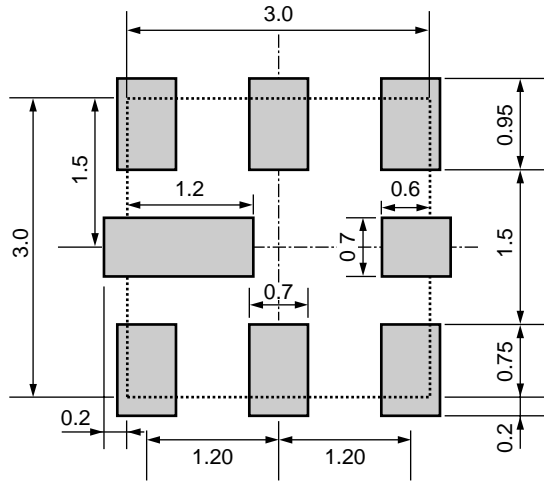

< G6CH package >

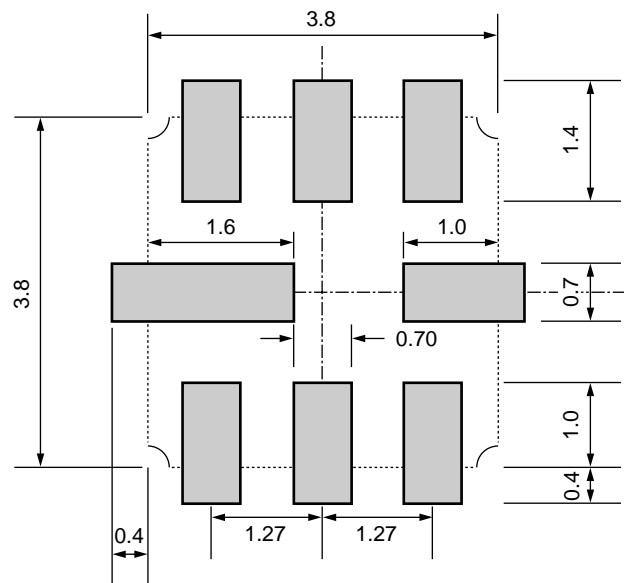

Dimensions in mm.

G5/G6 Series

■ PACKING

1. Reel type

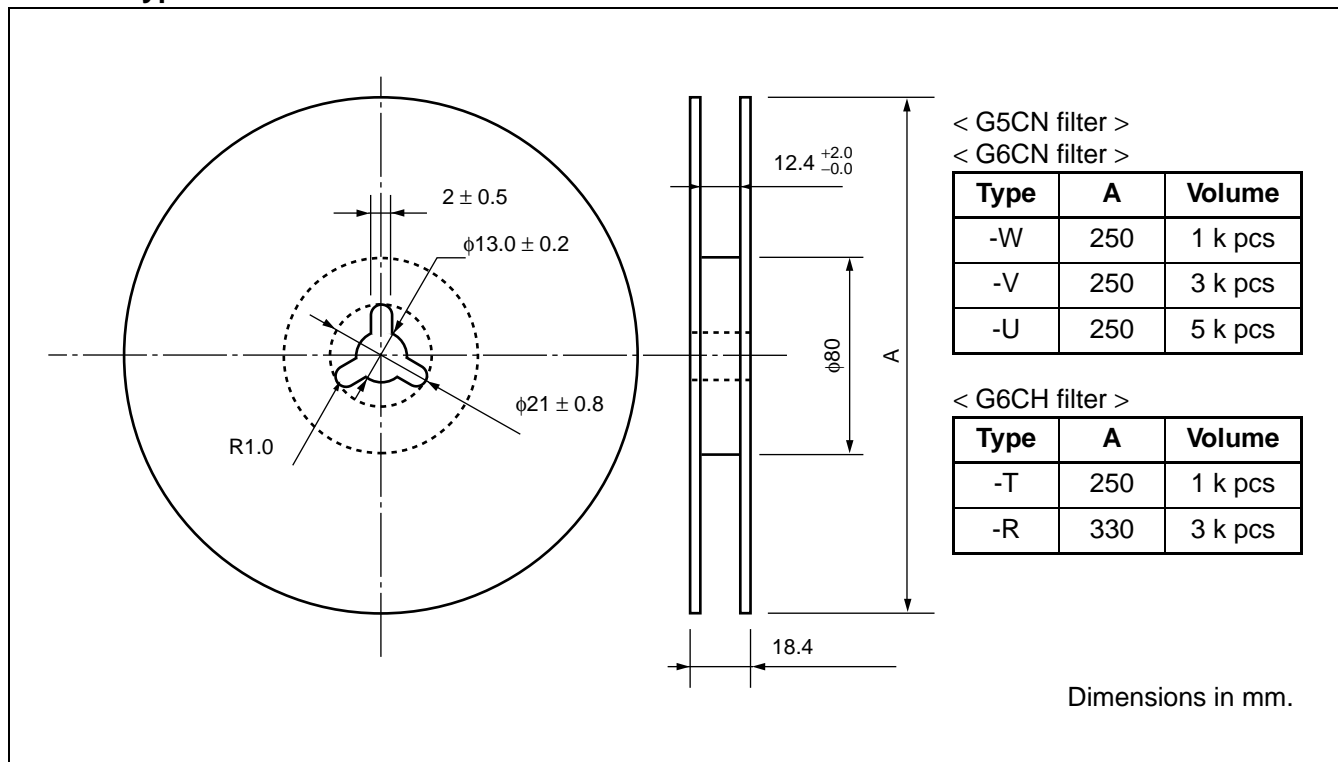

2. Packing Style

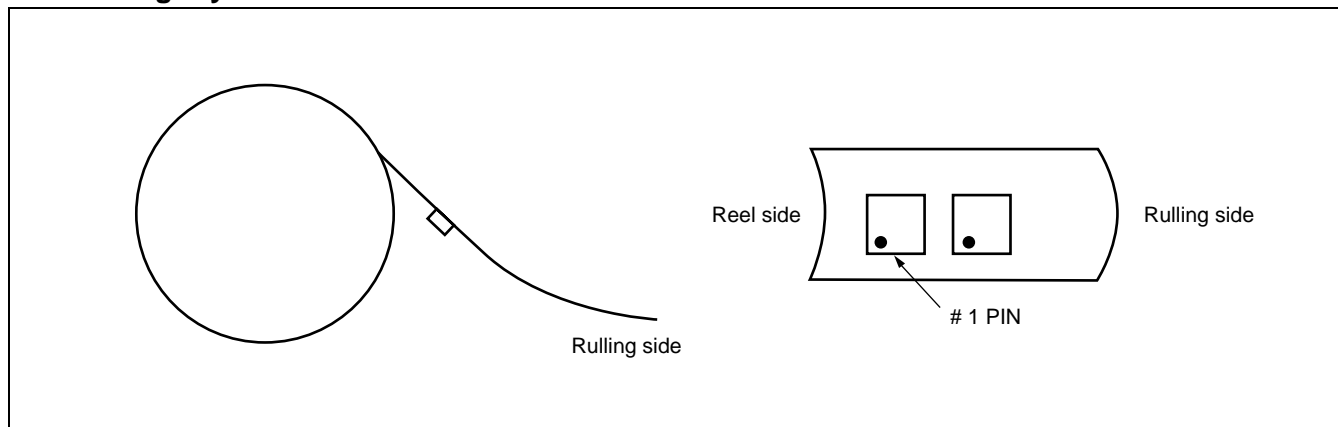

3. Tape Dimensions

< G5CN filters >

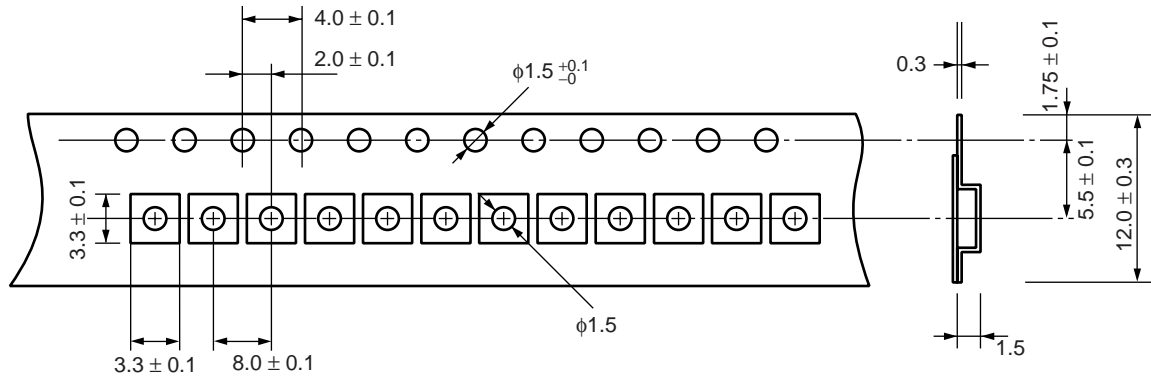

< G6CH filters >

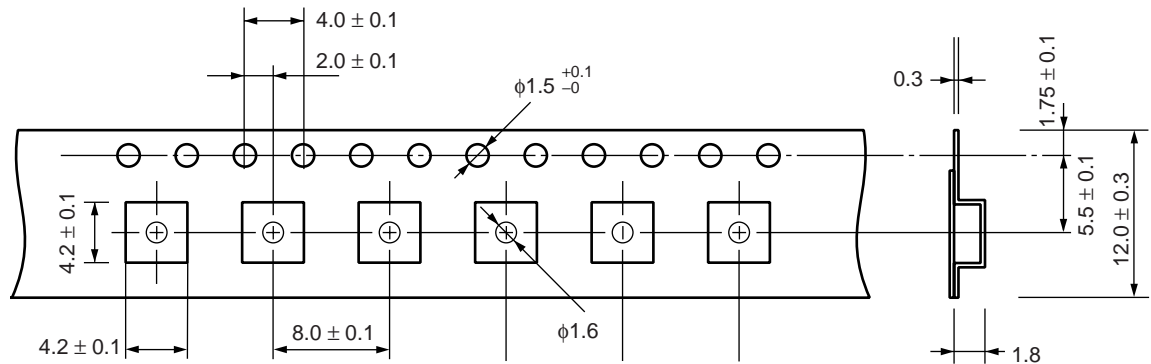

Dimensions in mm.

4. Peel strength of top cover tape

Peel off by the force of 0.1 N to 0.7 N under the condition at the right.
(Conforms to JIS C 0806 section 5.2)

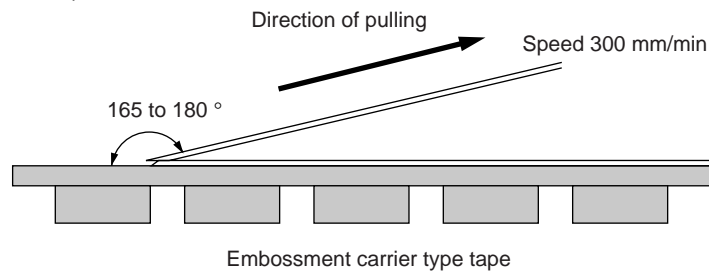

G5/G6 Series

RECOMMENDED REFLOW PROFILE

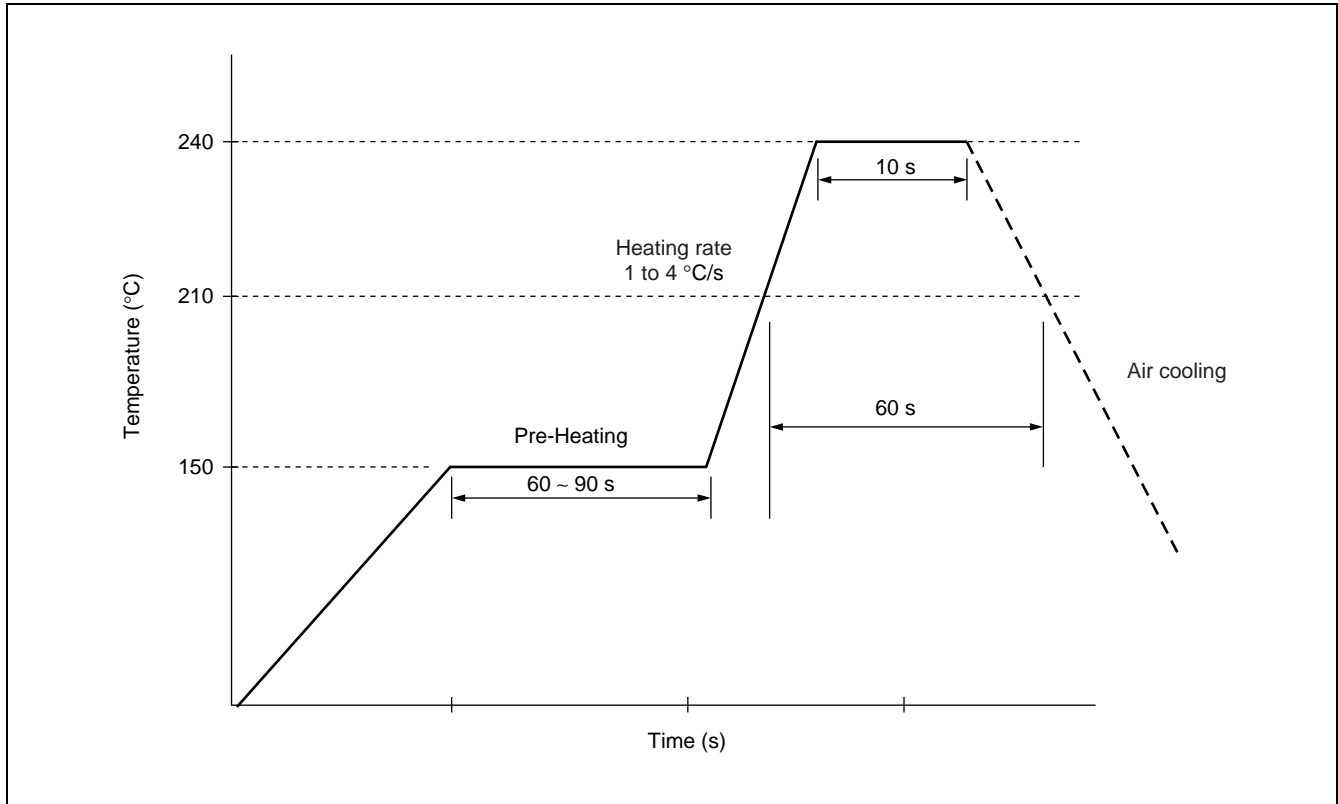

NOTE

Mass-produced product order is accepted by a unit of 1000.

G5/G6 Series

FUJITSU MEDIA DEVICES LIMITED

For further information please contact:

Japan

FUJITSU MEDIA DEVICES LIMITED
International Sales and Marketing Dept.
Sin-Yokohama Square Bldg., 14F,
Shin-Yokohama 2-3-12, Kouhoku-ku,
Yokohama-shi, Kanagawa 222-0033, Japan
Tel: +81-45-471-0061
Fax: +81-45-471-0076

<http://www.fujitsu.co.jp/hypertext/fmd/English/index.html>

North and South America

FUJITSU MICROELECTRONICS, INC.
3545 North First Street,
San Jose, CA 95134-1804, U.S.A.
Tel: +1-408-922-9000
Fax: +1-408-922-9179

Customer Response Center
Mon. - Fri.: 7 am - 5 pm (PST)
Tel: +1-800-866-8608
Fax: +1-408-922-9179

<http://www.fujitsumicro.com/>

Europe

FUJITSU MICROELECTRONICS EUROPE GmbH
Am Siebenstein 6-10,
D-63303 Dreieich-Buchsschlag,
Germany
Tel: +49-6103-690-0
Fax: +49-6103-690-122

<http://www.fujitsu-fme.com/>

Asia Pacific

FUJITSU MICROELECTRONICS ASIA PTE. LTD.
#05-08, 151 Lorong Chuan,
New Tech Park,
Singapore 556741
Tel: +65-281-0770
Fax: +65-281-0220

<http://www.fmap.com.sg/>

F0012

© FUJITSU LIMITED Printed in Japan

All Rights Reserved.

The contents of this document are subject to change without notice. Customers are advised to consult with FUJITSU sales representatives before ordering.

The information and circuit diagrams in this document are presented as examples of semiconductor device applications, and are not intended to be incorporated in devices for actual use. Also, FUJITSU is unable to assume responsibility for infringement of any patent rights or other rights of third parties arising from the use of this information or circuit diagrams.

The contents of this document may not be reproduced or copied without the permission of FUJITSU LIMITED.

FUJITSU semiconductor devices are intended for use in standard applications (computers, office automation and other office equipments, industrial, communications, and measurement equipments, personal or household devices, etc.).

CAUTION:

Customers considering the use of our products in special applications where failure or abnormal operation may directly affect human lives or cause physical injury or property damage, or where extremely high levels of reliability are demanded (such as aerospace systems, atomic energy controls, sea floor repeaters, vehicle operating controls, medical devices for life support, etc.) are requested to consult with FUJITSU sales representatives before such use. The company will not be responsible for damages arising from such use without prior approval.

Any semiconductor devices have inherently a certain rate of failure. You must protect against injury, damage or loss from such failures by incorporating safety design measures into your facility and equipment such as redundancy, fire protection, and prevention of over-current levels and other abnormal operating conditions.

If any products described in this document represent goods or technologies subject to certain restrictions on export under the Foreign Exchange and Foreign Trade Control Law of Japan, the prior authorization by Japanese government should be required for export of those products from Japan.