

Schottky Barrier Diodes (Surface Mount) 40V

Parameter Type No.	Absolute Maximum Ratings					Electrical Characteristics (Ta = 25°C)						Others				
	VRM (V)	IF(AV) (A)	IFSM (A) 50Hz Half-cycle Sinewave Single Shot	Tj (°C)	Tstg (°C)	VF (V)		IR (mA)	IR (H)	trr (ns)	Rth(j-ℓ) (°C/W)	Mass (g)	Fig.			
						max	IF (A)	VR = VRM max	VR = VRM Ta = 100°C max							
SSB-14	40	0.5	4	-40 to +150		0.58	0.5	0.1	5	50	100/100	150.0	0.009	Ⓐ		
SFPB-54		1.0	30			0.55	1.0	1.0	50							
SFPB-64		1.5	60				2.0	5.0								
SFPB-74		2.0	40			0.50	2.0	0.2	20 (Tj = 150°C)						—	—
SFPE-64		2.0														

SSB-14

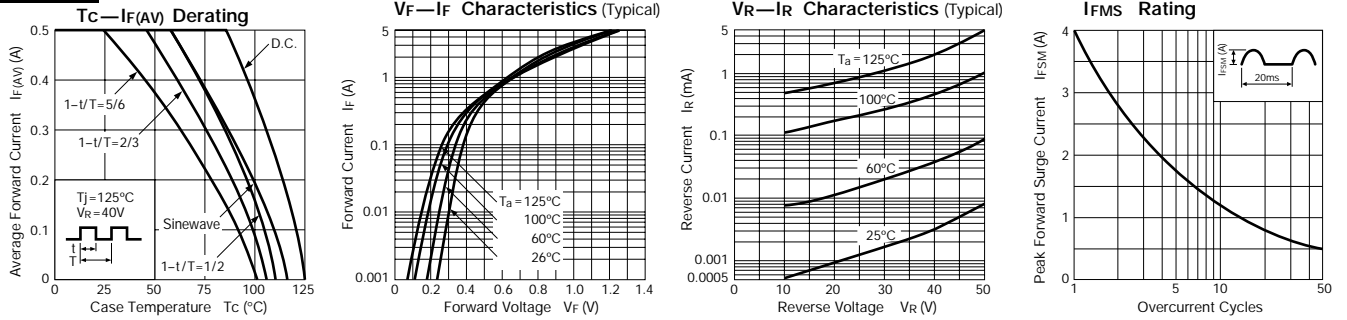

SFPB-54

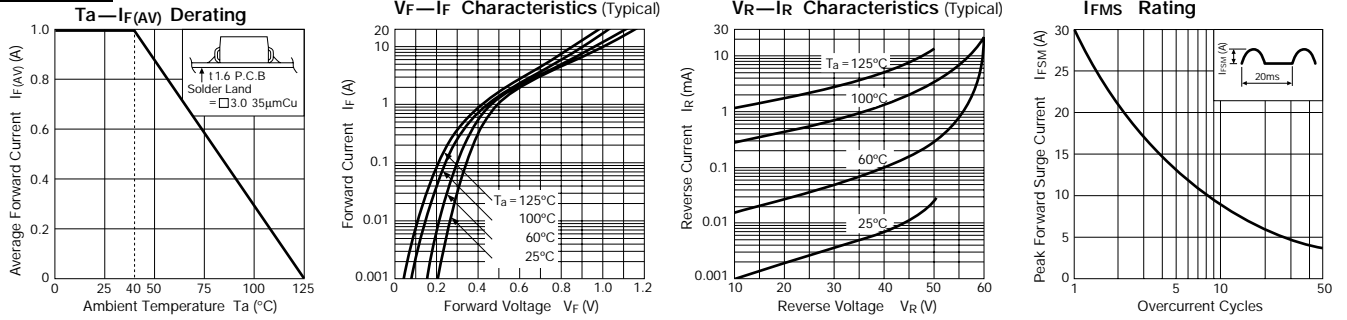

SFPB-64

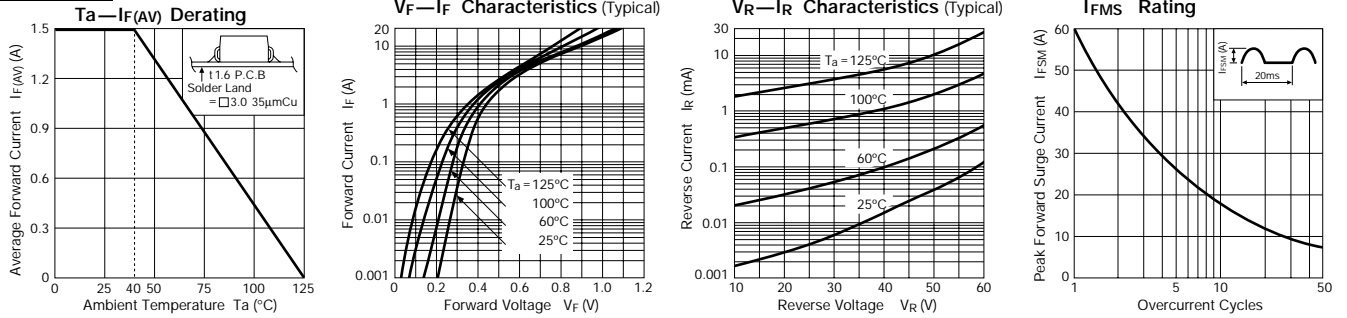

External Dimensions (Unit: mm)

Flammability:
UL94V-0 or Equivalent

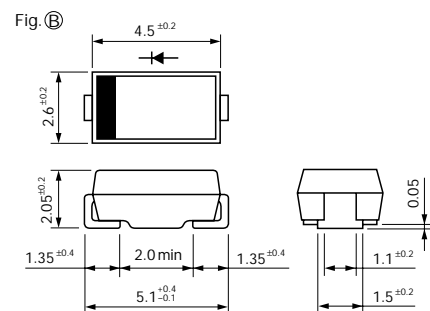
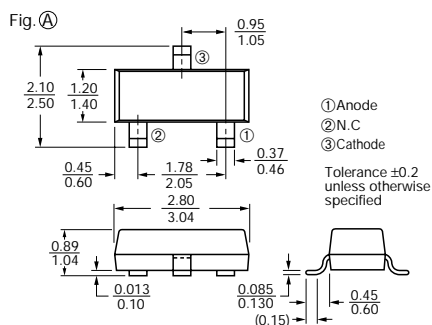

SFPB-74

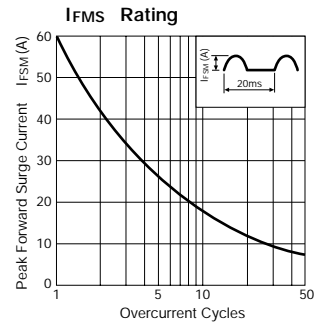
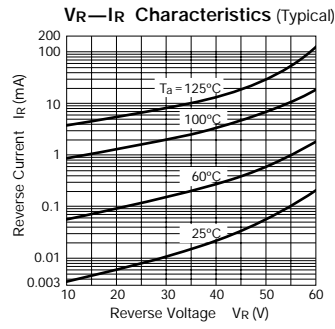
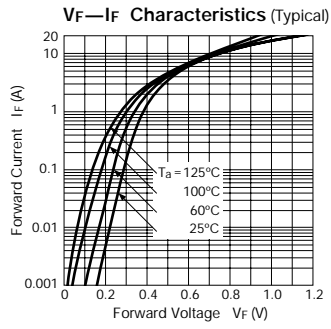
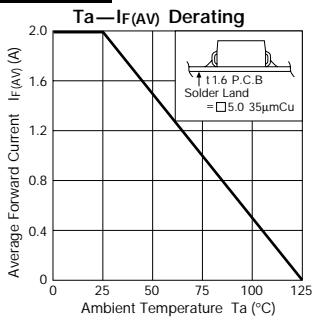

SFPE-64