

Silicon Bipolar MMIC 5 GHz Active Double Balanced Mixer/IF Amp

Technical Data

Features

- **8 dB RF-IF Conversion Gain From 0.05 - 5 GHz**
- **IF Output from DC to 1 GHz**
- **Low Power Dissipation:**
60 mW at $V_{CC} = 5\text{ V}$ Typ.
- **Single Polarity Bias Supply:**
 $V_{CC} = 4\text{ to }8\text{ V}$
- **Load-Insensitive Performance**
- **Conversion Gain Flat Over Temperature**
- **Low LO Power Requirements:**
-5 dBm Typical
- **Low RF to IF Feedthrough, Low LO Leakage**
- **Hermetic Ceramic Surface Mount Package**

Description

The IAM-81028 is a complete low-power-consumption double-balanced active mixer housed in a miniature ceramic hermetic surface mount package. It is designed for narrow or wide bandwidth commercial, industrial and military applications having RF inputs up to 5 GHz and IF outputs from DC to 1 GHz. Operation at RF and LO frequencies less than 50 MHz can be achieved using optional external capacitors to ground. The IAM-81028 is particularly well suited for applications that require load-insensitive conversion gain and good spurious signal suppression with minimum LO and bias power consumption. Typical applications include frequency down conversion,

IAM-81028

28 Package

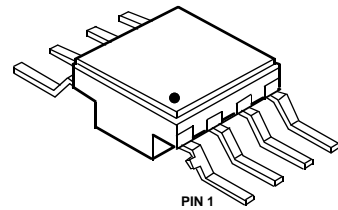

modulation, demodulation and phase detection for fiber-optic, GPS satellite navigation, mobile radio, and battery powered communications receivers.

The IAM series of Gilbert multiplier-based frequency converters is fabricated using HP's 10 GHz, f_T , 25 GHz f_{MAX} ISOSAT™-I silicon bipolar process. This process uses nitride self alignment, submicrometer lithography, trench isolation, ion implantation, gold metallization and polyimide inter-metal dielectric and scratch protection to achieve excellent performance, uniformity and reliability.

Typical Biasing Configuration and Functional Block Diagram

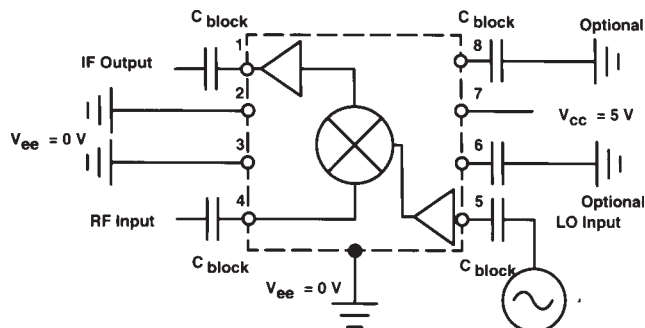

Note: No external BALUNs are required.

Absolute Maximum Ratings

Parameter	Absolute Maximum ^[1]
Device Voltage	15 V
Power Dissipation ^[2,3]	300 mW
RF Input Power	+14 dBm
LO Input Power	+14 dBm
Junction Temperature	200°C
Storage Temperature	-65°C to 200°C

Thermal Resistance:^[2,4]

$$\theta_{jc} = 50^{\circ}\text{C/W}$$

Notes:

1. Permanent damage may occur if any of these limits are exceeded.
2. $T_{\text{CASE}} = 25^{\circ}\text{C}$.
3. Derate at 20 mW/°C for $T_{\text{C}} > 185^{\circ}\text{C}$.
4. See MEASUREMENTS section "Thermal Resistance" in Communications Components Catalog, for more information.

Electrical Specifications^[1]

$T_{\text{A}} = 25^{\circ}\text{C}$

Symbol	Parameters and Test Conditions: $V_{\text{CC}} = 5 \text{ V}$, $Z_{\text{O}} = 50 \Omega$, $\text{LO} = -5 \text{ dBm}$, $\text{RF} = -20 \text{ dBm}$		Units	Min.	Typ.	Max.
G_{C}	Conversion Gain	RF = 2 GHz, LO = 1.75 GHz	dB	7.0	8.5	10
$f_{3\text{dBRF}}$	RF Bandwidth (G_{C} 3 dB Down)	IF = 250 MHz	GHz		4.5	
$f_{3\text{dBIF}}$	IF Bandwidth (G_{C} 3 dB Down)	LO = 2 GHz	GHz		0.6	
$P_{1\text{dB}}$	IF Output Power at 1 dB Gain Compression	RF = 2 GHz, LO = 1.75 GHz	dBm		-6	
IP_3	IF Output Third Order Intercept Point	RF = 2 GHz, LO = 1.75 GHz	dBm		3	
NF	SSB Noise Figure	RF = 2 GHz, LO = 1.75 GHz	dB		17	
VSWR	RF Port VSWR	$f = 0.05$ to 5 GHz			1.5:1	
	LO Port VSWR	$f = 0.05$ to 5 GHz			1.5:1	
	IF Port VSWR	$f < 1$ GHz			1.5:1	
RF_{if}	RF Feedthrough at IF Port	RF = 2 GHz, LO = 1.75 GHz	dBc		-25	
LO_{if}	LO Leakage at IF Port	LO = 1.75 GHz	dBm		-25	
LO_{rf}	LO Leakage at RF Port	LO = 1.75 GHz	dBm		-35	
I_{CC}	Supply Current		mA	10	12.5	16

Note:

1. The recommended operating voltage range for this device is 4 to 8 V. Typical performance as a function of voltage is on the following page.

Typical Performance, $T_A = 25^\circ\text{C}$, $V_{CC} = 5\text{ V}$
RF: -20 dBm at 2 GHz, LO: -5 dBm at 1.75 GHz
(unless otherwise noted)

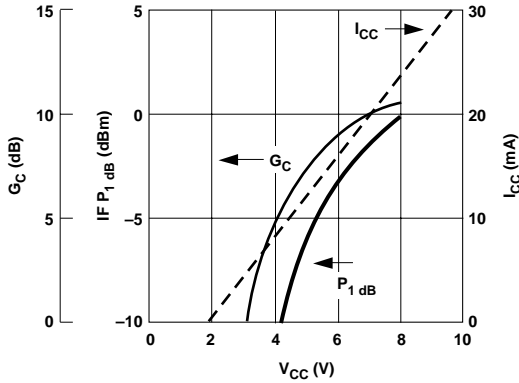

Figure 1. Conversion Gain, IF P_1 dB and I_{CC} Current vs. V_{CC} Bias Voltage.

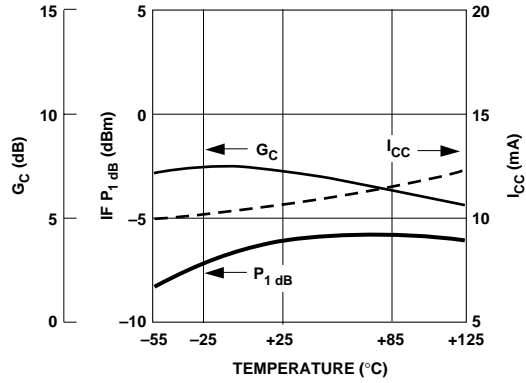

Figure 2. Conversion Gain, IF P_1 dB and I_{CC} Current vs. Case Temperature.

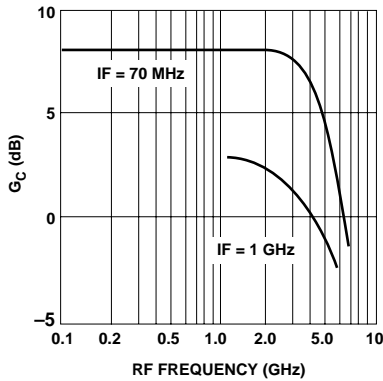

Figure 3. Typical RF to IF Conversion Gain vs. RF Frequency, $T_A = 25^\circ\text{C}$ (Low Side LO).

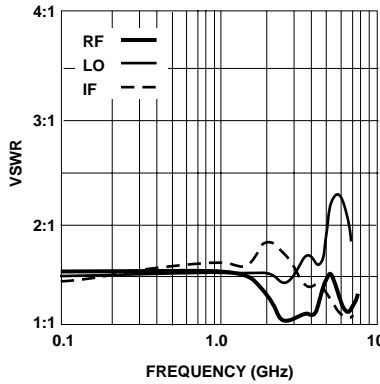

Figure 4. RF, LO and IF Port VSWR vs. Frequency.

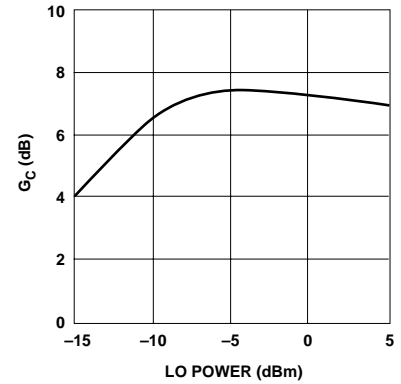

Figure 5. RF to IF Conversion Gain vs. LO Power.

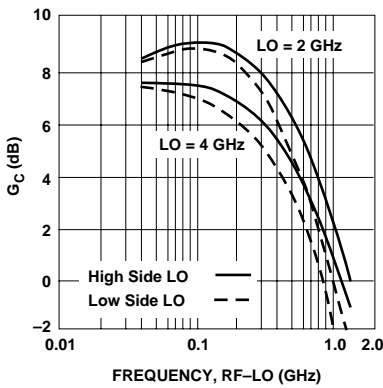

Figure 6. RF to IF Conversion Gain vs. IF Frequency.

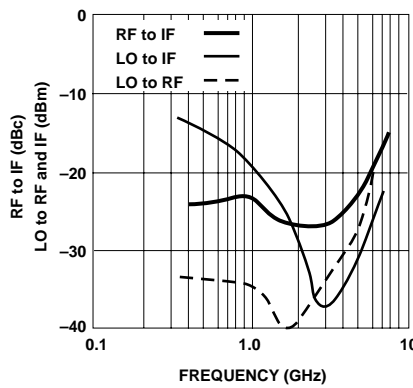

Figure 7. RF Feedthrough Relative to IF Carrier, dBm LO to RF and IF Leakage vs. Frequency.

HARMONIC LO ORDER	0	1	2	3	4	5
HARMONIC RF ORDER	0	1	2	3	4	5
$X_{mn} = P_{if} - P_{(m-rf - n-lo)}$	-	21	35	>75	>75	>75
1	12	0	48	48	>75	>75
2	13	41	39	71	>75	>75
3	36	28	53	57	>75	>75
4	27	49	49	72	>75	>75
5	45	35	63	62	>75	>75

Figure 8. Harmonic Intermodulation Suppression (dB Below Desired Output) RF at 1 GHz, LO at 0.752 GHz, IF at 0.248 GHz.

Package Dimensions

28 Package

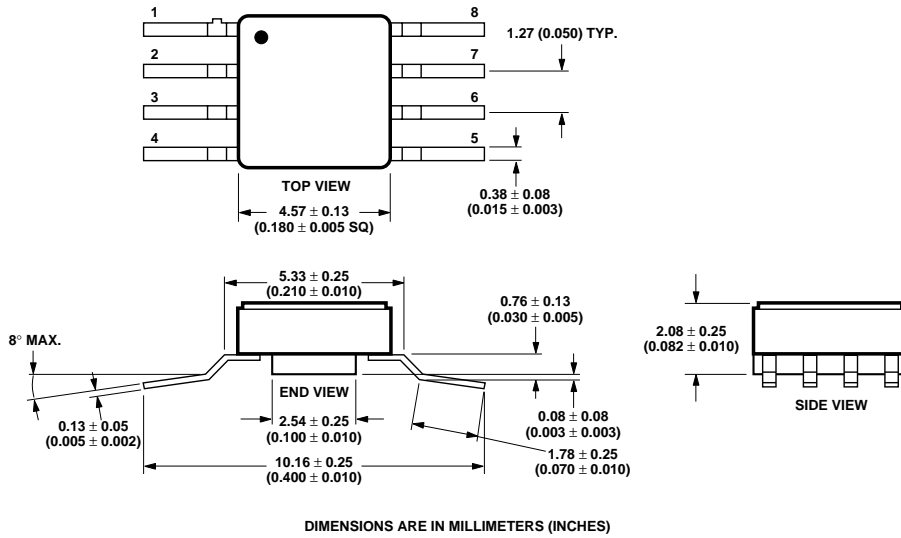

DIMENSIONS ARE IN MILLIMETERS (INCHES)

Package marking code is "M810"