

# Silicon Bipolar MMIC 5 GHz Active Double Balanced Mixer/IF Amp

## Technical Data

### IAM-81008

#### Features

- **RF-IF Conversion Gain From 0.05–5 GHz**
- **IF Conversion Gain From DC to 1 GHz**
- **Low Power Dissipation:**  
65 mW at  $V_{CC} = 5\text{ V}$  Typical
- **Single Polarity Bias Supply:**  
 $V_{CC} = 4\text{ to }8\text{ V}$
- **Load-insensitive Performance**
- **Conversion Gain Flat Over Temperature**
- **Low LO Power Requirements:**  
–5 dBm Typical
- **Low Cost Plastic Surface Mount Package**

Typical applications include frequency down conversion, modulation, demodulation and phase detection. Markets include fiber-optics, GPS satellite navigation, mobile radio, and battery powered communications receivers.

The IAM series of Gilbert multiplier-based frequency converters is fabricated using HP's 10 GHz,  $f_T$ , 25 GHz  $f_{MAX}$  ISOSAT™-I silicon bipolar process. This process uses nitride self alignment, submicrometer lithography, trench isolation, ion implantation, gold metallization and polyimide inter-metal dielectric and scratch protection to achieve excellent performance, uniformity and reliability.

#### Plastic SO-8 Package

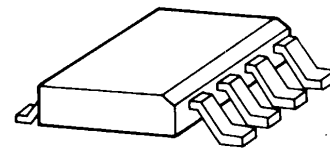

#### Pin Configuration

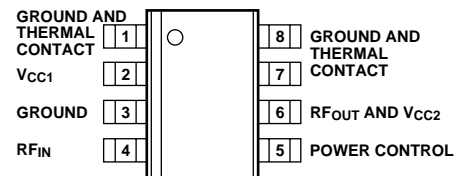

#### Description

The IAM-81008 is a complete low power consumption, double balanced active mixer housed in a miniature low cost plastic surface mount package. It is designed for narrow or wide bandwidth commercial and industrial applications having RF inputs up to 5 GHz. Operation at RF and LO frequencies less than 50 MHz can be achieved using optional external capacitors to ground. The IAM-81008 is particularly well suited for applications that require load-insensitive conversion and good spurious signal suppression with minimum LO and bias power consumption.

#### Typical Biasing Configuration and Functional Block Diagram

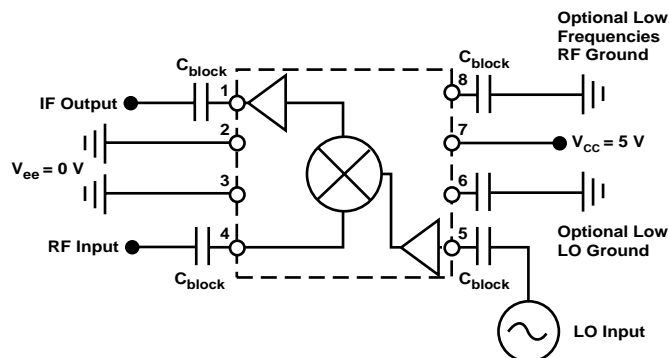

Note: No external baluns are required.

## IAM-81008 Absolute Maximum Ratings

Parameter	Absolute Maximum <sup>[1]</sup>
Device Voltage	10 V
Power Dissipation <sup>2,3</sup>	300 mW
RF Input Power	+14 dBm
LO Input Power	+14 dBm
Junction Temperature	150°C
Storage Temperature	-65 to 150°C

### Thermal Resistance:

$$\theta_{jc} = 80^{\circ}\text{C/W}$$

#### Notes:

1. Permanent damage may occur if any of these limits are exceeded.
2.  $T_{\text{CASE}} = 25^{\circ}\text{C}$ .
3. Derate at 4.4 mW/°C for  $T_{\text{C}} > 82^{\circ}\text{C}$ .

## IAM-81008 Part Number Ordering Information

Part Number	Devices Per Reel	Reel Size
IAM-81008-TR1	1000	7"

For more information, see "Tape and Reel Packaging for Semiconductor Devices".

## IAM-81008 Electrical Specifications<sup>[1]</sup>, $T_{\text{A}} = 25^{\circ}\text{C}$

Symbol	Parameters and Test Conditions: $V_{\text{cc}} = 5 \text{ V}$ , $Z_0 = 50 \Omega$ , LO = -5 dBm, RF = -20 dBm	Units	Min.	Typ.	Max.
$G_{\text{C}}$	Conversion Gain RF = 2 GHz, LO = 1.75 GHz	dB	6.0	8.5	10
$F_{3 \text{ dB RF}}$	RF Bandwidth ( $G_{\text{C}}$ 3 dB Down) IF = 250 MHz	GHz		3.5	
$F_{3 \text{ dB IF}}$	IF Bandwidth ( $G_{\text{C}}$ 3 dB Down) LO = 2 GHz	GHz		0.6	
$P_{1 \text{ dB}}$	IF Output Power at 1 dB Gain Compression RF = 2 GHz, LO = 1.75 GHz	dBm		-6	
$IP_3$	IF Output Third Order Intercept Point RF = 2 GHz, LO = 1.75 GHz	dBm		3	
NF	SSB Noise Figure RF = 2 GHz, LO = 1.75 GHz	dB		17	
VSWR	RF Port VSWR $f = 0.05$ to 3.5 GHz			1.5:1	
	LO Port VSWR $f = 0.05$ to 3.5 GHz			2.0:1	
	IF Port VSWR $f < 1$ GHz			1.5:1	
$RF_{\text{if}}$	RF Feedthrough at IF Port RF = 2 GHz, LO = 1.75 GHz	dBc		-25	
$LO_{\text{if}}$	LO Leakage at IF Port LO = 1.75 GHz	dBm		-25	
$LO_{\text{rf}}$	LO Leakage at RF Port LO = 1.75 GHz	dBm		-30	
$I_{\text{CC}}$	Supply Current	mA	10	13	16

#### Note:

1. The recommended operating voltage range for this device is 4 to 8 V. Typical performance as a function of voltage is on the following page.

**IAM-81008 Typical Performance,  $T_A = 25^\circ\text{C}$ ,  $V_{CC} = 5\text{ V}$**   
**RF:  $-20\text{ dBm}$  at  $2\text{ GHz}$ , LO:  $-5\text{ dBm}$  at  $1.75\text{ GHz}$**   
(unless otherwise noted)

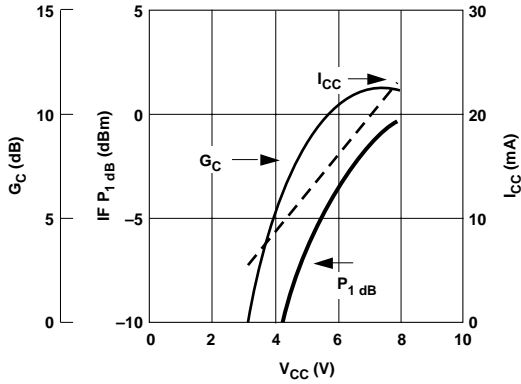

**Figure 1. Conversion Gain, IF  $P_1\text{ dB}$  and  $I_{CC}$  Current vs.  $V_{CC}$  Bias Voltage.**

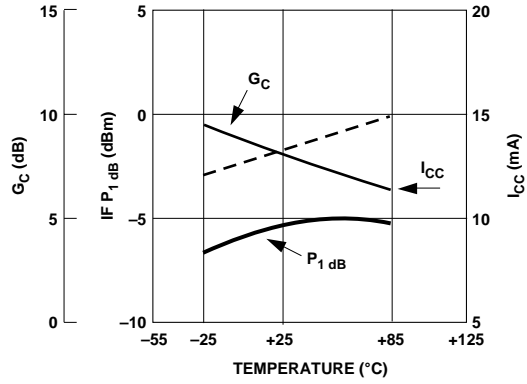

**Figure 2. Conversion Gain, IF  $P_1\text{ dB}$  and  $I_{CC}$  Current vs. Case Temperature.**

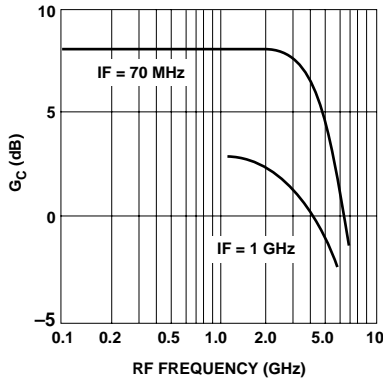

**Figure 3. Typical RF to IF Conversion Gain vs. RF Frequency,  $T_A = 25^\circ\text{C}$  (Low Side LO).**

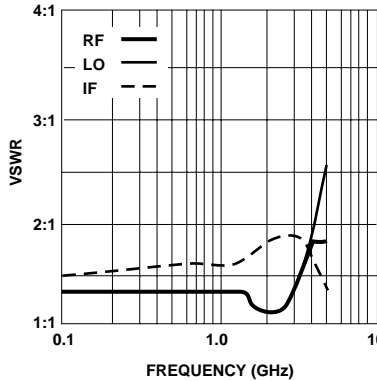

**Figure 4. RF, LO and IF Port VSWR vs. Frequency.**

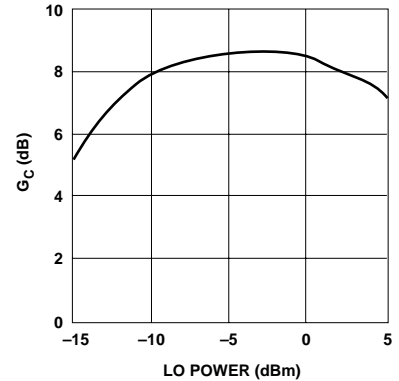

**Figure 5. RF to IF Conversion Gain vs. LO Power.**

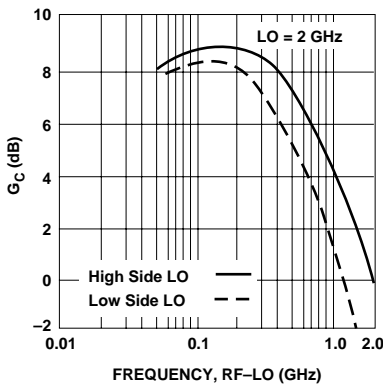

**Figure 6. RF to IF Conversion Gain vs. IF Frequency.**

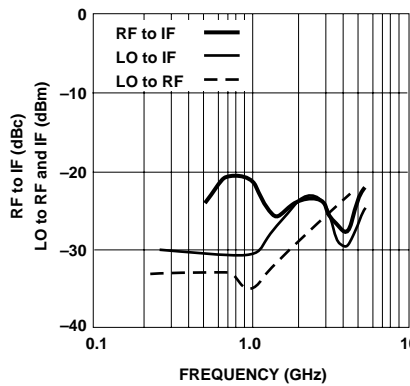

**Figure 7. RF Feedthrough Relative to IF Carrier, dBm LO to RF and IF Leakage vs. Frequency.**

HARMONIC LO ORDER	HARMONIC RF ORDER					
	0	1	2	3	4	5
0	—	21	35	74	>75	>75
1	18	0	45	48	>75	>75
2	16	35	42	72	>75	>75
3	42	20	44	59	>75	>75
4	29	44	52	64	>75	>75
5	45	36	57	64	>75	>75

$X_{mn} = P_{if} - P(m^{*}rf - n^{*}lo)$

**Figure 8. Harmonic Intermodulation Suppression (dB Below Desired Output) RF at  $1\text{ GHz}$ , LO at  $0.752\text{ GHz}$ , IF at  $0.248\text{ GHz}$ .**

# Package Dimensions

## SO-8 Plastic Package

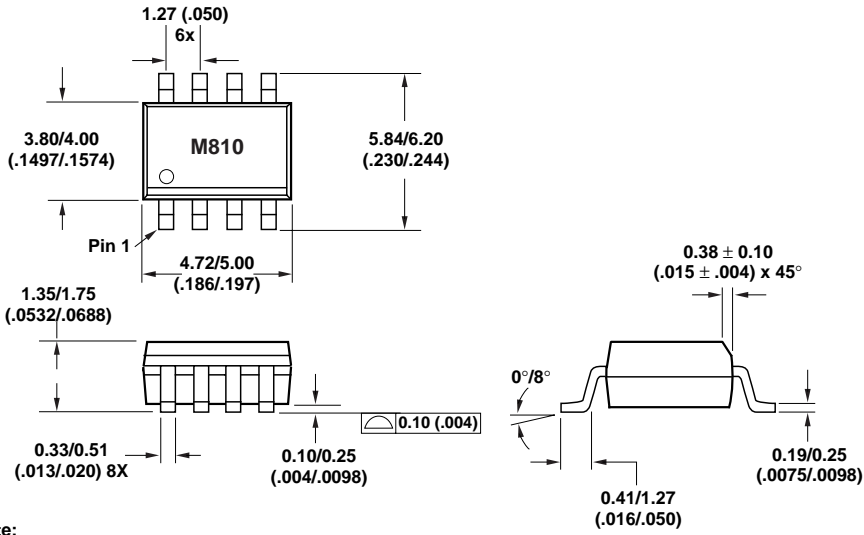

**Note:**

1. Dimensions are shown in millimeters (inches).