

Description

- Capacitor Microphone application

Features

- Especially suited for use in audio, telephone capacitor microphones
- Excellent voltage characteristic
- Excellent transient characteristic

Ordering Information

Type NO.	Marking	Package Code
STK596M	K596	TO-92M

Outline Dimensions

unit : mm

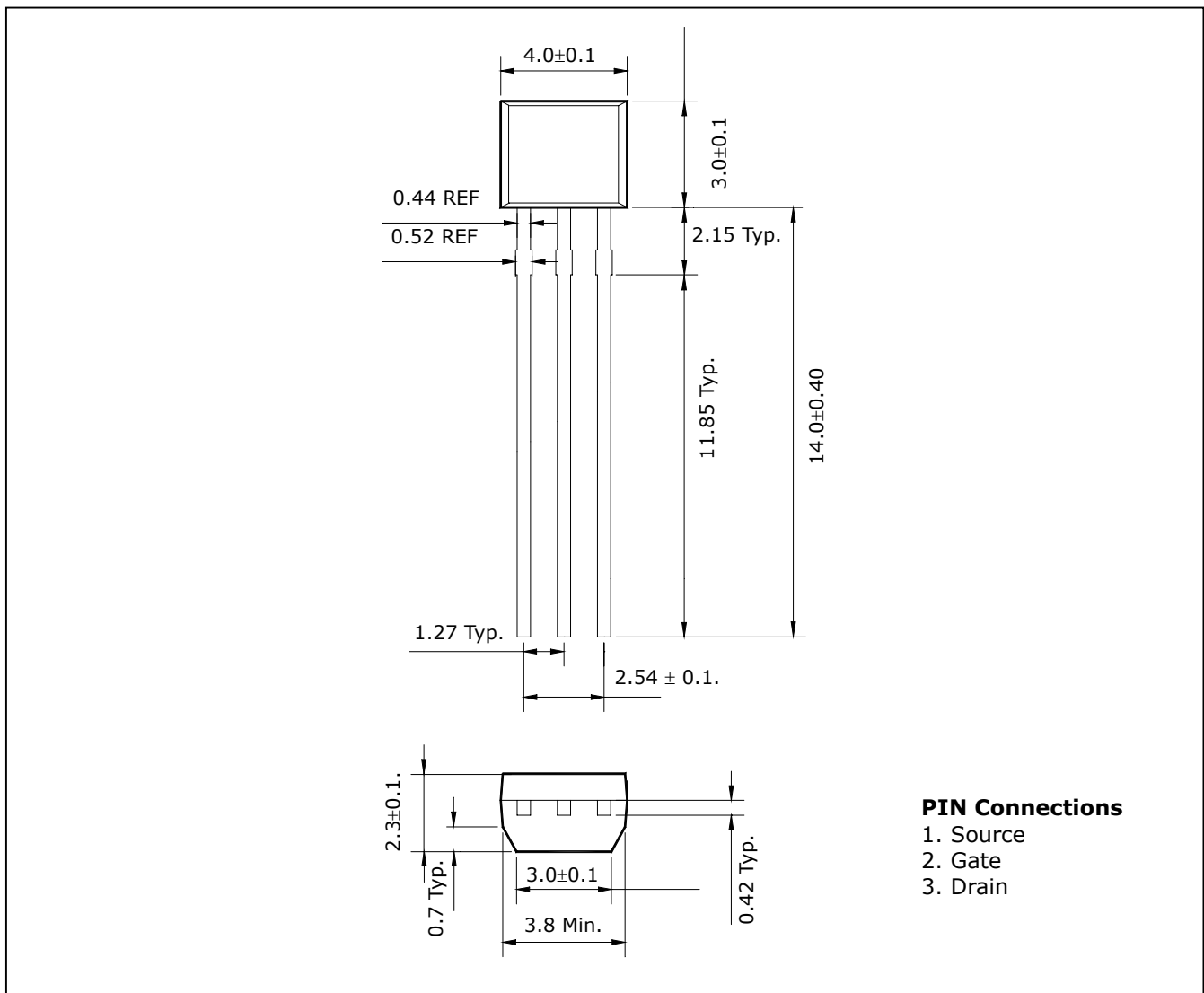

PIN Connections

1. Source
2. Gate
3. Drain

Absolute maximum ratings

(Ta=25°C)

Characteristic	Symbol	Rating	Unit
Gate-Drain voltage	V_{GDO}	-20	V
Gate Current	I_G	10	mA
Drain Current	I_D	1	mA
Power dissipation	P_D	100	mW
Junction Temperature	T_J	150	°C
Storage Temperature range	T_{stg}	-55~150	°C

Electrical Characteristics

(Ta=25°C)

Characteristic	Symbol	Test Condition	Min.	Typ.	Max.	Unit
Gate-drain breakdown voltage	$V_{(BR)GDO}$	$I_G = -100\mu A$	-20			V
Cutoff voltage	$V_{GS(off)}$	$V_{DS} = 5V, I_D = 1\mu A$		-0.6	-1.5	V
Zero Voltage Drain current	I_{DSS}	$V_{DS} = 5V, V_{GS} = 0$	100		800	μA
Forward transfer admittance	$ y_{fs} $	$V_{DS} = 5V, V_{GS} = 0, f = 1KHz$	0.4	1.2		mS
Input capacitance	C_{iss}	$V_{DS} = 5V, V_{GS} = 0, f = 1MHz$		3.5		pF
Reverse Transfer capacitance	C_{rss}	$V_{DS} = 5V, V_{GS} = 0, f = 1MHz$		0.65		pF
Output Noise Voltage	V_{NO}	$V_{IN} = 0, A \text{ CURVE}$			-1 1 0	dB

I_{DSS} Classification

Classification	A	B	C	D	E
$I_{DSS}[\mu A]$	100 ~ 170	150 ~ 240	210 ~ 350	320 ~ 480	440 ~ 800

Noise Voltage Test Circuit

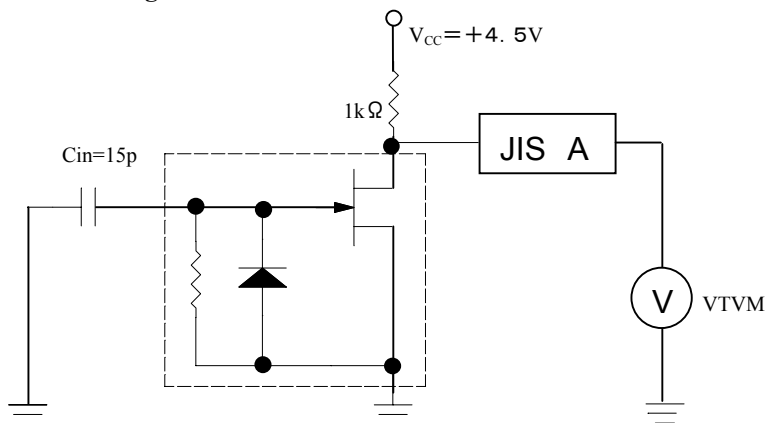

Electrical Characteristic Curves

Fig. 1 $I_D - V_{DS}$

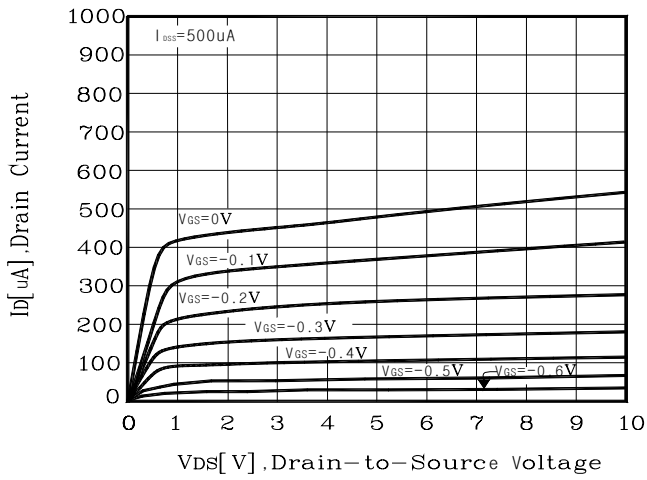

Fig. 2 $I_D - V_{DS}$

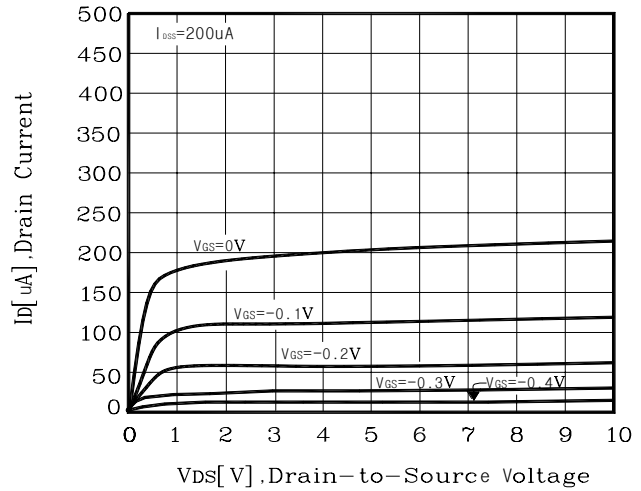

Fig. 3 $I_D - V_{GS}$

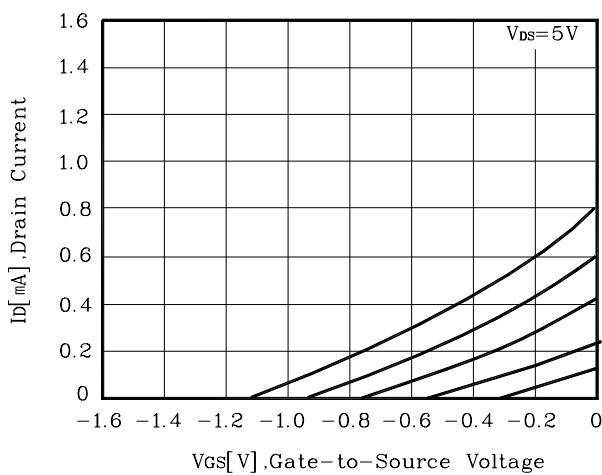

Fig. 4 $|Y_{fs}| - I_{DSS}$

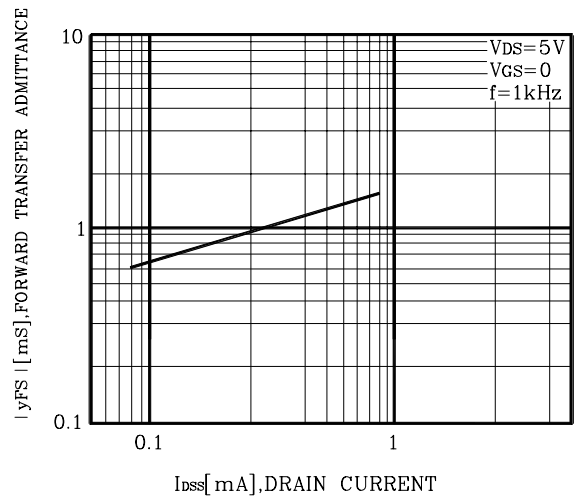

Fig. 5 $V_{GS(Off)} - I_{DSS}$

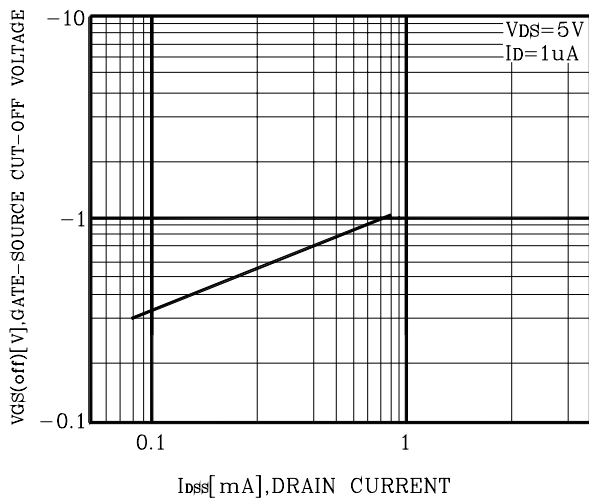
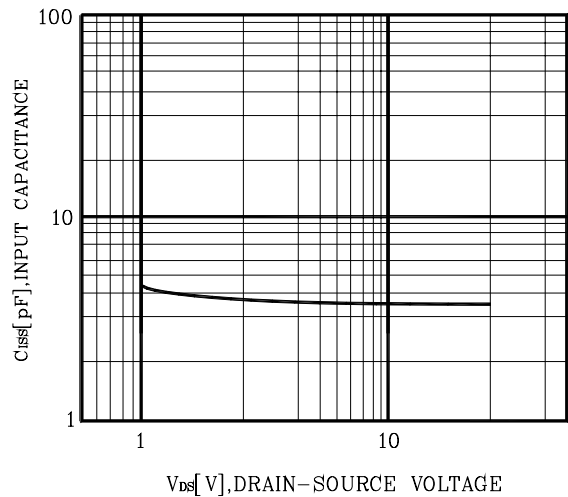

Fig. 6 $C_{iss} - V_{DS}$



Electrical Characteristic Curves

Fig. 7 C_{rss} - V_{DS}

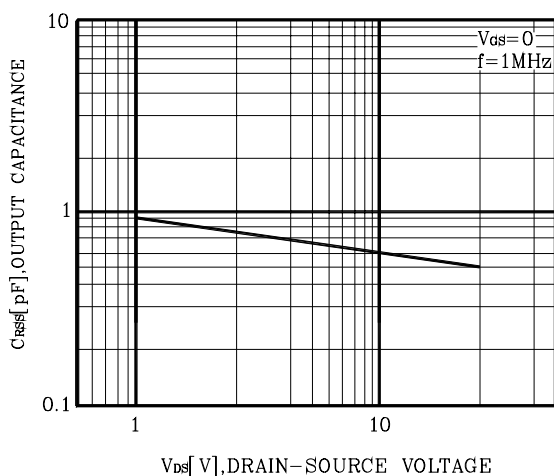

Fig. 8 P_D - T_a

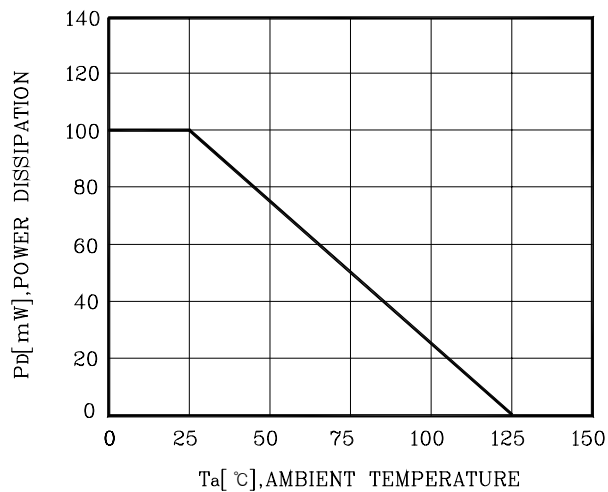
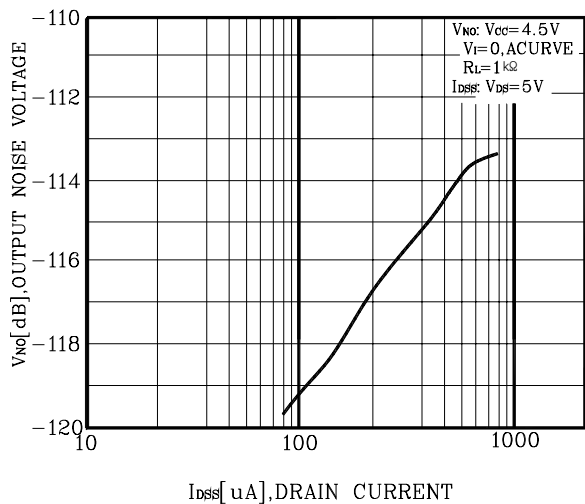

Fig. 9 V_{NO} - I_{DSS}



These AUK products are intended for usage in general electronic equipments(Office and communication equipment, measuring equipment, domestic electrification, etc.).

Please make sure that you consult with us before you use these AUK products in equipments which require high quality and/or reliability, and in equipments which could have major impact to the welfare of human life(atomic energy control, airplane, spaceship, traffic signal, combustion central, all types of safety device, etc.).

AUK cannot accept liability to any damage which may occur in case these AUK products were used in the mentioned equipments without prior consultation with AUK.