

PQ05RF12/PQ05RF13 Series

1A Output Low Power-Loss Voltage Regulators Considering Power Line Voltage Drop

■ Features

- Low power-loss (Dropout voltage : MAX.0.5V)
- Compact resin full-mold package
- Output voltage value (5.3V, 9.3V, 12.3V) with an allowance for power line voltage drop
- The high-precision output voltage models are also available. (output voltage precision : $\pm 2.5\%$)
- Built-in ON/OFF control function.

■ Applications

- Series power supply for various electronic equipment such as VCRs and electronic instruments

■ Model Line-ups

Output voltage	5.3V output	9.3V output	12.3V output
Output voltage precision: $\pm 5\%$	PQ05RF12	PQ09RF12	PQ12RF12
Output voltage precision: $\pm 2.5\%$	PQ05RF13	PQ09RF13	PQ12RF13

■ Absolute Maximum Ratings

($T_a=25^\circ\text{C}$)

Parameter	Symbol	Rating	Unit
*1 Input voltage	V_{IN}	35	V
*1 ON/OFF control terminal voltage	V_C	35	V
Output current	I_O	1	A
Power dissipation (No heat sink)	P_{D1}	1.5	W
Power dissipation (with infinite heat sink)	P_{D2}	15	W
*2 Junction temperature	T_j	150	$^\circ\text{C}$
Operating temperature	T_{opr}	-20 to +80	$^\circ\text{C}$
Storage temperature	T_{stg}	-40 to +150	$^\circ\text{C}$
Soldering temperature	T_{sol}	260 (For 10s)	$^\circ\text{C}$

*1 All are open except GND and applicable terminals.

*2 Overheat protection may operate at $125 < T_j < 150^\circ\text{C}$

■ Outline Dimensions

(Unit : mm)

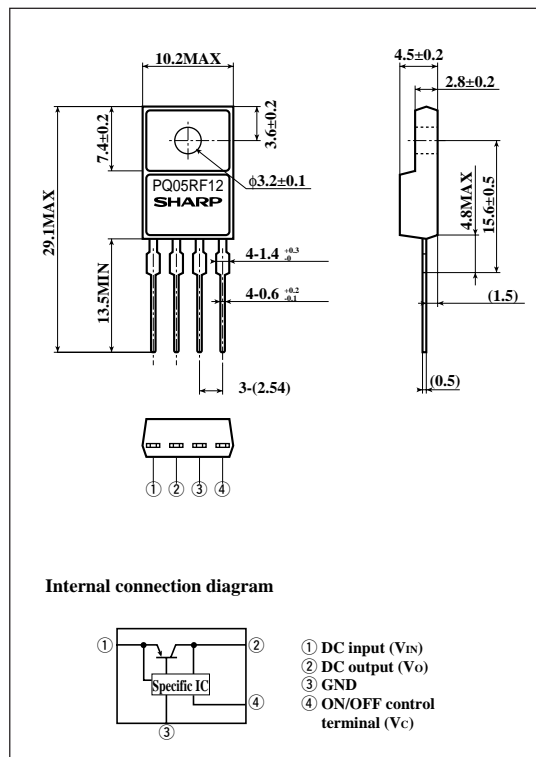

Internal connection diagram

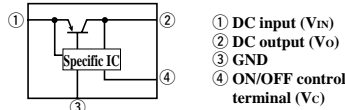

■ Electrical Characteristics

Unless otherwise specified, condition shall be $(V_{IN}=8V, I_o=0.5A(PQ05RF12/PQ05RF13))$
 $(V_{IN}=12V, I_o=0.5A(PQ09RF12/PQ09RF13))$
 $(V_{IN}=15V, I_o=0.5A(PQ12RF12/PQ12RF13))$

($T_a=25^\circ C$)

Parameter	Symbol	Conditions	MIN.	TYP.	MAX.	Unit	
Output voltage	V_o	-	PQ05RF12	5.04	5.3	5.56	V
			PQ09RF12	8.84	9.3	9.76	
			PQ12RF12	11.69	12.3	12.91	
			PQ05RF13	5.17	5.3	5.43	
			PQ09RF13	9.07	9.3	9.53	
			PQ12RF13	12.0	12.3	12.6	
Load regulation	R_{eL}	$I_o=5mA$ to 1.0A	-	0.1	2.0	%	
Line regulation	R_{eL}	$V_{IN}=7$ to 17V	-	0.5	2.5	%	
		$V_{IN}=11$ to 21V	-				
		$V_{IN}=14$ to 24V	-				
Temperature coefficient of output voltage	TcV_o	$T_j=0$ to $125^\circ C$	-	± 0.02	-	%/ $^\circ C$	
Ripple rejection	RR	Refer to Fig. 2	45	55	-	dB	
Dropout voltage	V_{i-o}	^{*3}	-	-	0.5	V	
ON-state voltage for control	$V_{C(ON)}$	^{*4}	2.0	-	-	V	
ON-state current for control	$I_{C(ON)}$	$V_C=2.7V$	-	-	20	μA	
OFF-state voltage for control	$V_{C(OFF)}$	-	-	-	0.8	V	
OFF-state current for control	$I_{C(OFF)}$	$V_C=0.4V$	-	-	-0.4	mA	
Quiescent current	I_q	$V_C=0A$	-	-	10	mA	

^{*3} Input voltage shall be the value when output voltage is 95% in comparison with the initial value.
^{*4} In case of opening control terminal ④, output voltage turns on.

Fig.1 Test Circuit

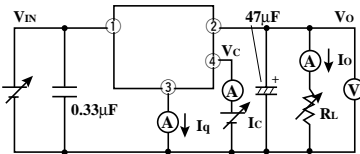
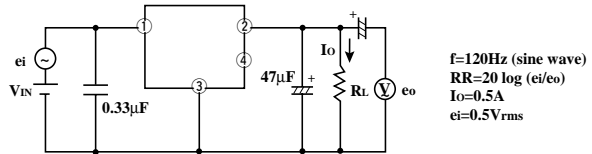
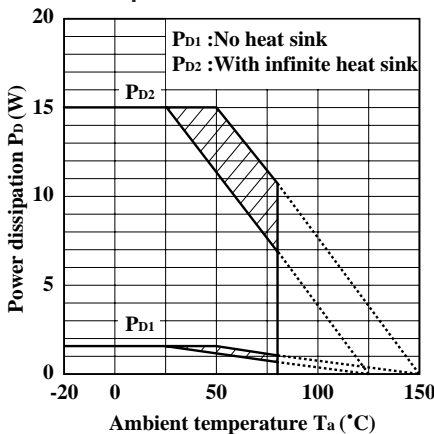

Fig.2 Test Circuit of Ripple Rejection



$f=120Hz$ (sine wave)
 $RR=20 \log (e_i/e_o)$
 $I_o=0.5A$
 $e_i=0.5Vrms$

Fig.3 Power Dissipation vs. Ambient Temperature



Note) Oblique line portion: Overheat protection may operate in this area.

Fig.4 Overcurrent Protection Characteristics (Typical Value)

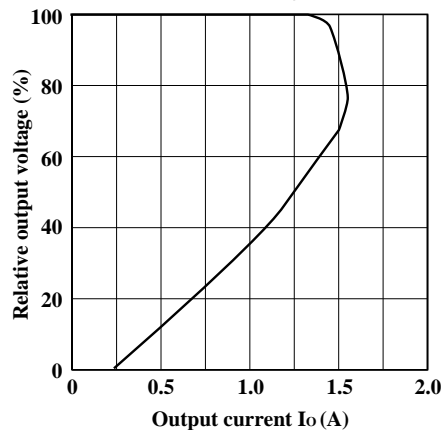

Fig.5 Output Voltage Deviation vs. Junction Temperature (PQ05RF12/PQ05RF13)

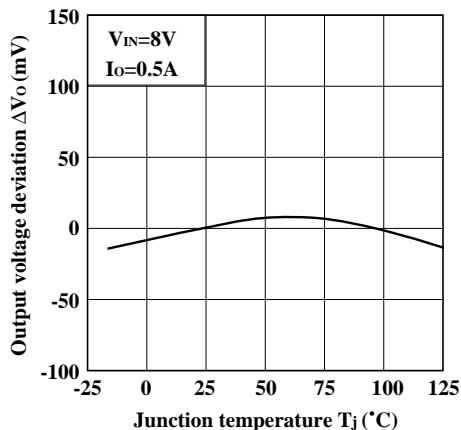

Fig.6 Output Voltage Deviation vs. Junction Temperature (PQ09RF12/PQ09RF13)

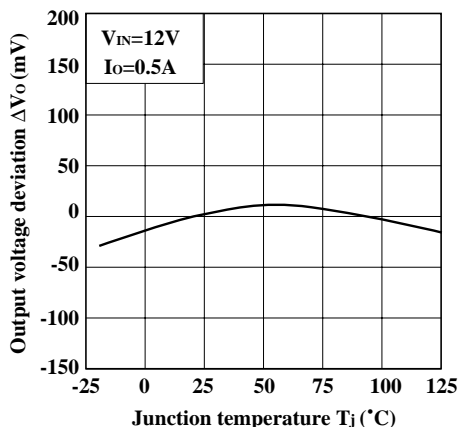

Fig.7 Output Voltage Deviation vs. Junction Temperature (PQ12RF12/PQ12RF13)

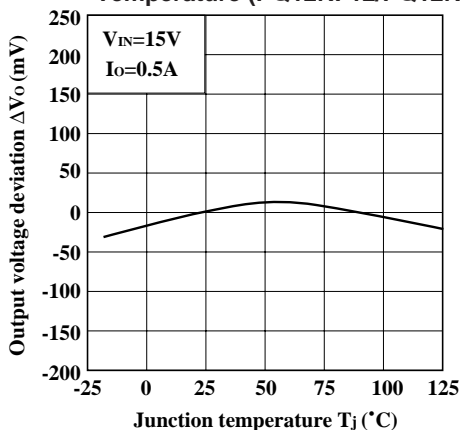

Fig.8 Output Voltage vs. Input Voltage (PQ05RF12/PQ05RF13)

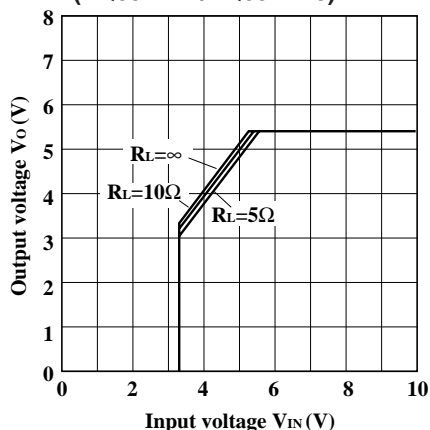

Fig.9 Output Voltage vs. Input Voltage (PQ09RF12/PQ09RF13)

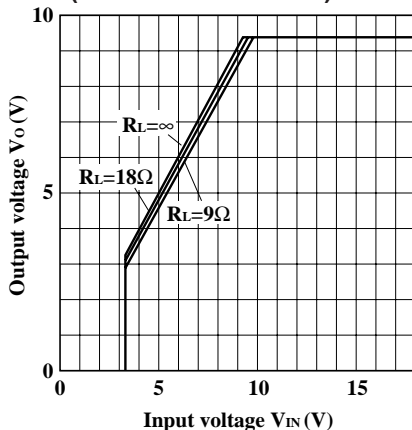

Fig.10 Output Voltage vs. Input Voltage (PQ12RF12/PQ12RF13)

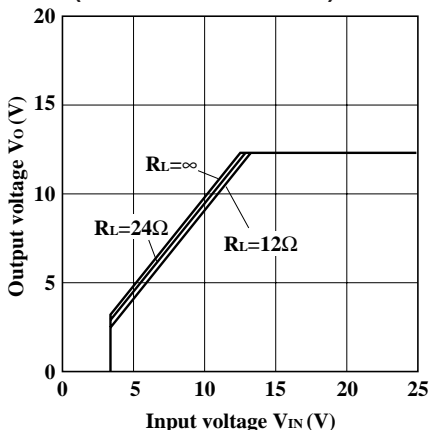

Fig.11 Circuit Operating Current vs. Input Voltage (PQ05RF12/PQ05RF13)

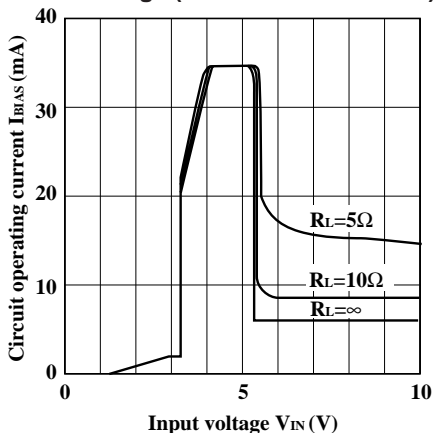

Fig.12 Circuit Operating Current vs. Input Voltage (PQ09RF12/PQ09RF13)

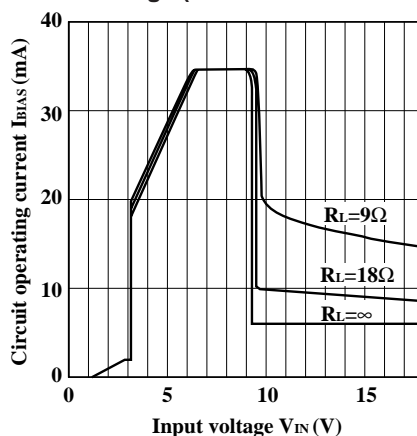

Fig.13 Circuit Operating Current vs. Input Voltage (PQ12RF12/PQ12RF13)

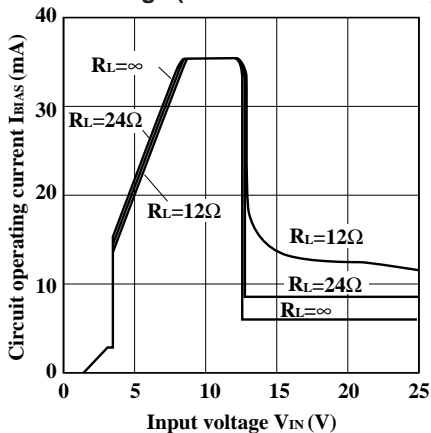

Fig.14 Dropout Voltage vs. Junction Temperature

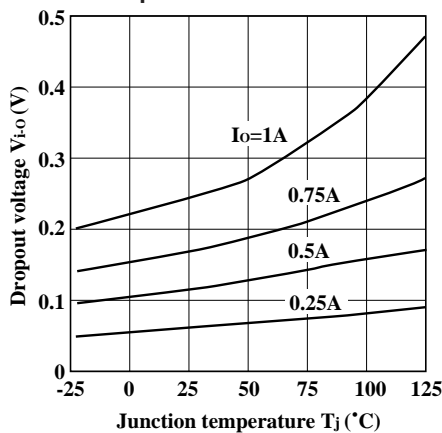

Fig.15 Quiescent Current vs. Junction Temperature

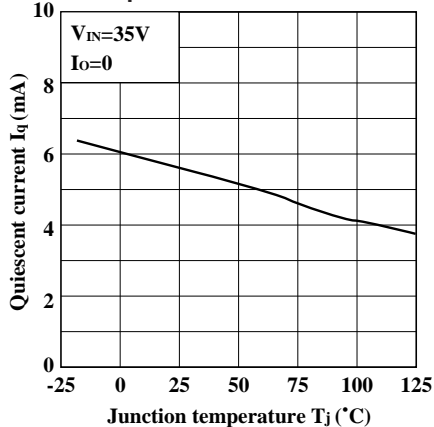

Fig.16 Ripple Rejection vs. Input Ripple Frequency

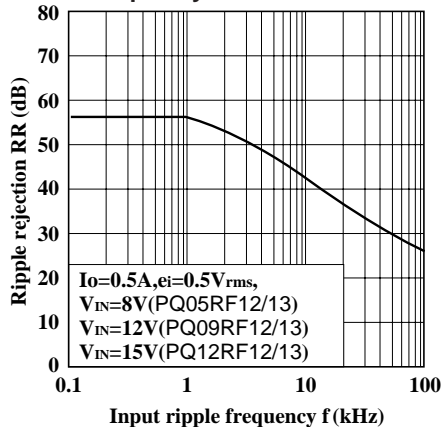

Fig.17 Ripple Rejection vs. Output Current

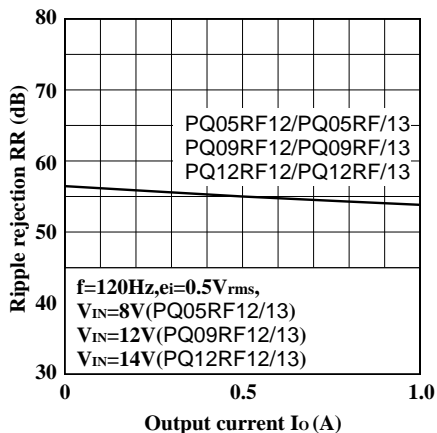

Fig.18 Output Peak Current vs. Dropout Voltage

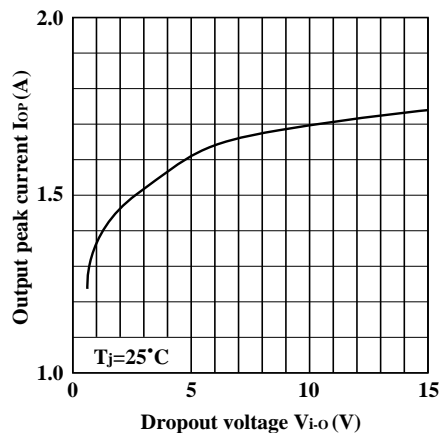

Fig.19 Output Peak Current vs. Junction Temperature

