

MC100LVEP210

Low-Voltage 1:5 Dual Diff. LVECL/LVPECL/LVEPECL/HSTL Clock Driver

The MC100LVEP210 is a low skew 1-to-5 dual differential driver, designed with clock distribution in mind. The LVECL/LVPECL input signals can be either differential or single-ended if the V_{BB} output is used. The signal is fanned out to 5 identical differential outputs. HSTL inputs can be used when the EP210 is operating in LVPECL mode.

The LVEP210 specifically guarantees low output-to-output skew. Optimal design, layout, and processing minimize skew within a device and from lot to lot.

To ensure the tight skew specification is realized, both sides of the differential output need to be terminated identically into 50Ω even if only one side is being used. When fewer than all ten pairs are used, identically terminate all the output pairs on the same package side whether used or unused. If no outputs on a single side are used, then leave these outputs open (unterminated). This will maintain minimum output skew. Failure to do this will result in a 10–20ps loss of skew margin (propagation delay) in the output(s) in use.

The MC100LVEP210, as with most other LVECL devices, can be operated from a positive V_{CC} supply in LVPECL mode. This allows the LVEP210 to be used for high performance clock distribution in +3.3V or +2.5V systems. Single ended input operation is limited to a $V_{CC} \geq 3.0V$ in PECL mode, or $V_{EE} \leq -3.0V$ in ECL mode.

Designers can take advantage of the LVEP210's performance to distribute low skew clocks across the backplane or the board. In a LVPECL environment, series or Thevenin line terminations are typically used as they require no additional power supplies. For more information on using PECL, designers should refer to Application Note AN1406/D.

- 100ps Part-to-Part Skew
- 35ps Output-to-Output Skew
- Differential Design
- V_{BB} Output
- 475ps Typical Propagation Delay
- High Bandwidth to 1.5GHz Typical
- LVPECL and HSTL mode: 2.375V to 3.8V V_{CC} with $V_{EE} = 0V$
- LVECL mode: 0V V_{CC} with $V_{EE} = -2.375V$ to $-3.8V$
- Internal Input Resistors: Pulldown on D, \overline{D}
- Pullup and Pulldown on \overline{CLK}
- ESD Protection: >2KV HBM, >100V MM
- Moisture Sensitivity Level 2
For Additional Information, See Application Note AND8003/D
- Flammability Rating: UL-94 code V-0 @ 1/8",
Oxygen Index 28 to 34
- Transistor Count = 461 devices



ON Semiconductor
Formerly a Division of Motorola
<http://onsemi.com>



32-LEAD TQFP
FA SUFFIX
CASE 873A

MARKING DIAGRAM*

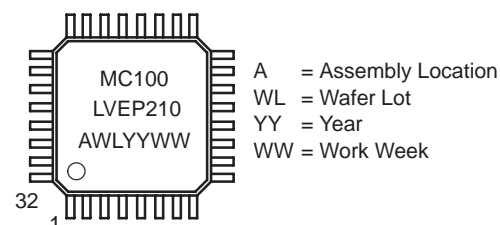

*For additional information, see Application Note AND8002/D

ORDERING INFORMATION

Device	Package	Shipping
MC100LVEP210FA	TQFP	250 Units/Tray
MC100LVEP210FAR2	TQFP	2000 Tape & Reel

MC100LVEP210

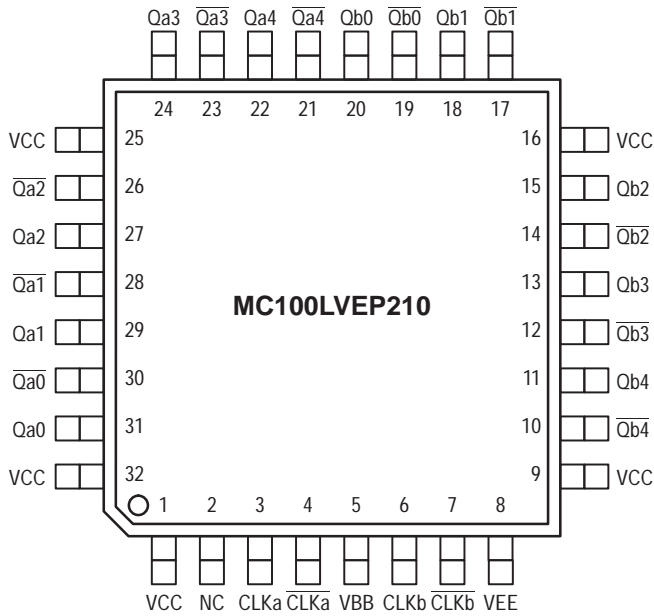

Figure 1. 32-Lead TQFP Pinout (Top View)

Warning: All V_{CC} and V_{EE} pins must be externally connected to Power Supply to guarantee proper operation.

PIN DESCRIPTION	
PIN	FUNCTION
CLKn/ $\overline{\text{CLKn}}$	LVECL/LVPECL/HSTL CLK Inputs
Qn0:4/ $\overline{\text{Qn0:4}}$	LVECL/LVPECL Outputs
VBB	Reference Voltage Output
VCC	Positive Supply
VEE	Negative, 0 Supply

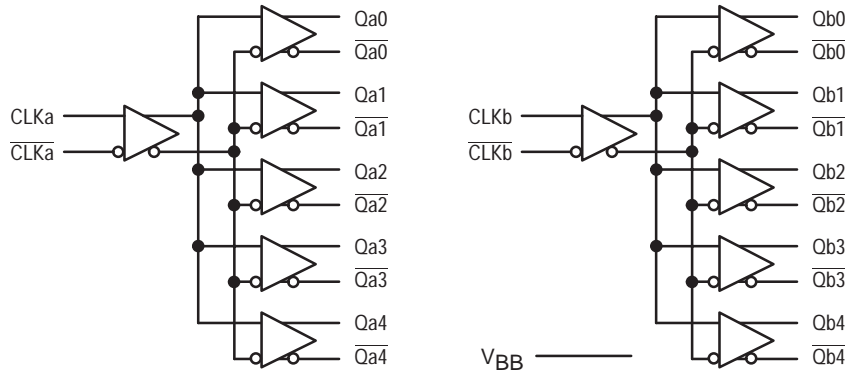

Figure 2. Logic Symbol

MAXIMUM RATINGS*

Symbol	Parameter	Value	Unit	
V _{EE}	Power Supply (V _{CC} = 0V)	-6.0 to 0	VDC	
V _{CC}	Power Supply (V _{EE} = 0V)	6.0 to 0	VDC	
V _I	Input Voltage (V _{CC} = 0V, V _I not more negative than V _{EE})	-6.0 to 0	VDC	
V _I	Input Voltage (V _{EE} = 0V, V _I not more positive than V _{CC})	6.0 to 0	VDC	
I _{out}	Output Current	Continuous Surge	50 100	mA
I _{BB}	V _{BB} Sink/Source Current†	± 0.5	mA	
T _A	Operating Temperature Range	-40 to +85	°C	
T _{stg}	Storage Temperature	-65 to +150	°C	
θ _{JA}	Thermal Resistance (Junction-to-Ambient)	Still Air 500lfpm	80 55	°C/W
θ _{JC}	Thermal Resistance (Junction-to-Case)	12 to 17	°C/W	
T _{sol}	Solder Temperature (<2 to 3 Seconds: 245°C desired)	265	°C	

* Maximum Ratings are those values beyond which damage to the device may occur.

† Use for inputs of same package only.

MC100LVEP210

DC CHARACTERISTICS, ECL/LVECL ($V_{CC} = 0V$; $V_{EE} = -3.3(+0.925, -0.5)V$) (Note 5.)

Symbol	Characteristic	-40°C			25°C			85°C			Unit
		Min	Typ	Max	Min	Typ	Max	Min	Typ	Max	
IEE	Power Supply Current (Note 1.)	60	70	90	60	70	90	60	70	90	mA
VOH	Output HIGH Voltage (Note 2.)	-1145	-1020	-895	-1145	-1020	-895	-1145	-1020	-895	mV
VOL	Output LOW Voltage (Note 2.)	-1995	-1820	-1650	-1995	-1820	-1650	-1995	-1820	-1650	mV
VIH	Input HIGH Voltage Single Ended	-1165		-880	-1165		-880	-1165		-880	mV
VIL	Input LOW Voltage Single Ended	-1810		-1625	-1810		-1625	-1810		-1625	mV
VBB	Output Voltage Reference (Note 3.)	-1525	-1425	-1325	-1525	-1425	-1325	-1525	-1425	-1325	mV
VIHCMR	Input HIGH Voltage Common Mode Range (Note 4.)	$V_{EE}+1.2$		0.0	$V_{EE}+1.2$		0.0	$V_{EE}+1.2$		0.0	V
I _{IH}	Input HIGH Current			150			150			150	μA
I _{IL}	Input LOW Current	CLK CLK	0.5 -150		0.5 -150			0.5 -150			μA

NOTE: 100EP circuits are designed to meet the DC specifications shown in the above table after thermal equilibrium has been established. The circuit is in a test socket or mounted on a printed circuit board and transverse airflow greater than 500lfpm is maintained.

1. $V_{CC} = 0V$, $V_{EE} = V_{EEmin}$ to V_{EEmax} , all other pins floating.
2. All loading with 50 ohms to $V_{CC}-2.0$ volts.
3. Single ended input operation is limited $V_{EE} \leq -3.0V$ in ECL/LVECL mode.
4. V_{IHCMR} min varies 1:1 with V_{EE} , max varies 1:1 with V_{CC} .
5. Input and output parameters vary 1:1 with V_{CC} .

DC CHARACTERISTICS, LVPECL ($V_{CC} = 3.3V \pm 0.5V$, $V_{EE} = 0V$) (Note 10.)

Symbol	Characteristic	-40°C			25°C			85°C			Unit
		Min	Typ	Max	Min	Typ	Max	Min	Typ	Max	
IEE	Power Supply Current (Note 6.)	60	70	90	60	70	90	60	70	90	mA
VOH	Output HIGH Voltage (Note 7.)	2155	2280	2405	2155	2280	2405	2155	2280	2405	mV
VOL	Output LOW Voltage (Note 7.)	1305	1480	1650	1305	1480	1650	1305	1480	1650	mV
VIH	Input HIGH Voltage Single Ended	2135		2420	2135		2420	2135		2420	mV
VIL	Input LOW Voltage Single Ended	1490		1675	1490		1675	1490		1675	mV
VBB	Output Voltage Reference (Note 8.)	1775	1875	1975	1775	1875	1975	1775	1875	1975	mV
VIHCMR	Input HIGH Voltage Common Mode Range (Note 9.)	1.2		3.3	1.2		3.3	1.2		3.3	V
I _{IH}	Input HIGH Current			150			150			150	μA
I _{IL}	Input LOW Current	CLK CLK	0.5 -150		0.5 -150			0.5 -150			μA

NOTE: 100EP circuits are designed to meet the DC specifications shown in the above table after thermal equilibrium has been established. The circuit is in a test socket or mounted on a printed circuit board and transverse airflow greater than 500lfpm is maintained.

6. $V_{CC} = 3.3V \pm 0.5V$, $V_{EE} = 0V$, all other pins floating.
7. All loading with 50 ohms to $V_{CC}-2.0$ volts.
8. Single ended input operation is limited $V_{CC} \geq -3.0V$ in PECL mode.
9. V_{IHCMR} min varies 1:1 with V_{EE} , max varies 1:1 with V_{CC} .
10. Input and output parameters vary 1:1 with V_{CC} .

MC100LVEP210

DC CHARACTERISTICS, LVEPECL ($V_{CC} = 2.5V \pm 0.125V$, $V_{EE} = 0V$) (Note 14.)

Symbol	Characteristic	-40°C			25°C			85°C			Unit
		Min	Typ	Max	Min	Typ	Max	Min	Typ	Max	
IEE	Power Supply Current (Note 11.)	60	70	90	60	70	90	60	70	90	mA
VOH	Output HIGH Voltage (Note 12.)	1355	1480	1605	1355	1480	1605	1355	1480	1605	mV
VOL	Output LOW Voltage (Note 12.)	505	680	850	505	680	850	505	680	850	mV
VIH	Input HIGH Voltage Single Ended	1335		1620	1335		1620	1335		1620	mV
VIL	Input LOW Voltage Single Ended	690		875	690		875	690		875	mV
VIHCMR	Input HIGH Voltage Common Mode Range (Note 13.)	1.2		2.5	1.2		2.5	1.2		2.5	V
I _{IH}	Input HIGH Current			150			150			150	μA
I _{IL}	Input LOW Current	0.5			0.5			0.5			μA
		CLK			CLK			CLK			
		-150			-150			-150			

NOTE: 100EP circuits are designed to meet the DC specifications shown in the above table after thermal equilibrium has been established. The circuit is in a test socket or mounted on a printed circuit board and transverse airflow greater than 500lfpm is maintained.

11. $V_{CC} = 2.5V$, $V_{EE} = 0V$, all other pins floating.

12. All loading with 50 ohms to V_{EE} .

13. V_{IHCMR} min varies 1:1 with V_{EE} , max varies 1:1 with V_{CC} .

14. Input and output parameters vary 1:1 with V_{CC} .

DC CHARACTERISTICS, HSTL ($V_{CC} = 2.5(-0.125, +1.3)V$, $V_{EE} = 0V$)

Symbol	Characteristic	-40°C			25°C			85°C			Unit
		Min	Typ	Max	Min	Typ	Max	Min	Typ	Max	
VIH	Input HIGH Voltage				1200						mV
VIL	Input LOW Voltage						400				mV
V ₃₃	Input Crossover Voltage				680		900				mV
I _{CC}	Power Supply Current (Note 15.)		100			100			100		mA

15. $V_{CC} = 2.375V$ to $3.8V$, $V_{EE} = 0V$, all other pins floating.

AC CHARACTERISTICS ($V_{CC} = 0V$; $V_{EE} = -2.5V$ to $-3.8V$) or ($V_{CC} = 2.5V$ to $3.8V$; $V_{EE} = 0V$)

Symbol	Characteristic	-40°C			25°C			85°C			Unit
		Min	Typ	Max	Min	Typ	Max	Min	Typ	Max	
f _{maxLVPECL}	Maximum Toggle Frequency for LVECL and LVPECL (Note 16.)					1.5					GHz
f _{maxHSTL}	Maximum Toggle Frequency for HSTL (Note 16.)					250					MHz
t _{PLH} , t _{PHL}	Propagation Delay Differential	200	300	400	200	350	450	300	500	750	ps
t _{SKEW}	Within Device Skew Duty Cycle Skew (Note 17.)		TBD TBD			25 100	35		TBD TBD		ps
t _{JITTER}	Cycle-to-Cycle Jitter		TBD			TBD			TBD		ps
V _{PP}	Input Voltage Swing (Diff.)	150	800	1200	150	800	1200	150	800	1200	mV
t _r t _f	Output Rise/Fall Times (20% – 80%)	100	170	270	100	180	290	100	280	350	ps

16. F_{max} guaranteed for functionality only.

17. Skew is measured between outputs under identical transitions of similar paths through a device. Duty cycle skew is defined only for differential operation when the delays are measured from the crosspoint of the inputs to the crosspoint of the outputs.

MC100LVEP210

PACKAGE DIMENSIONS

TQFP
FA SUFFIX
32-LEAD PLASTIC PACKAGE
CASE 873A-02
ISSUE A

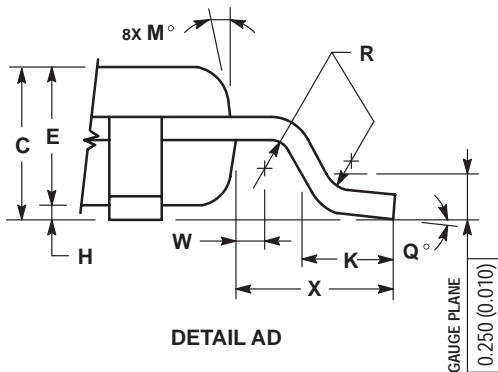
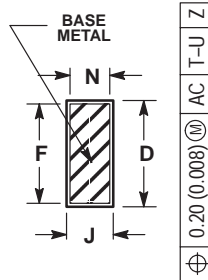
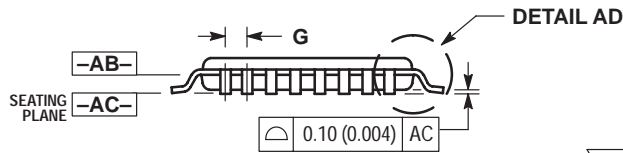
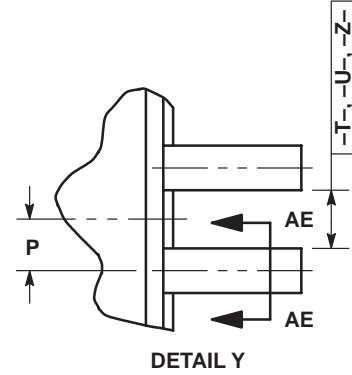
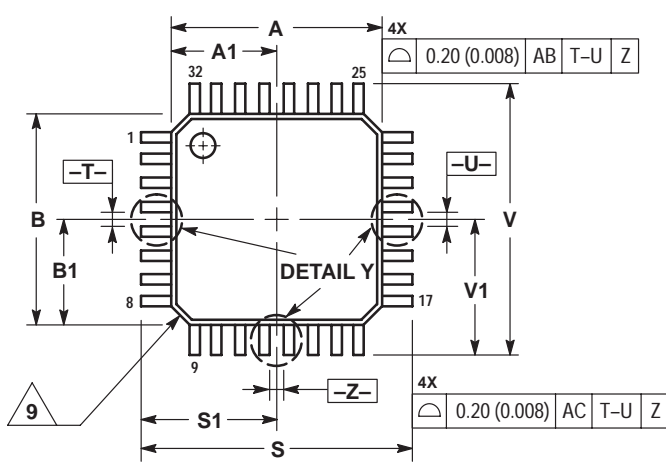

NOTES:

- DIMENSIONING AND TOLERANCING PER ANSI Y14.5M, 1982.
- CONTROLLING DIMENSION: MILLIMETER.
- DATUM PLANE -AB- IS LOCATED AT BOTTOM OF LEAD AND IS COINCIDENT WITH THE LEAD WHERE THE LEAD EXITS THE PLASTIC BODY AT THE BOTTOM OF THE PARTING LINE.
- DATUMS -T-, -U-, AND -Z- TO BE DETERMINED AT DATUM PLANE -AB-.
- DIMENSIONS S AND V TO BE DETERMINED AT SEATING PLANE -AC-.
- DIMENSIONS A AND B DO NOT INCLUDE MOLD PROTRUSION. ALLOWABLE PROTRUSION IS 0.250 (0.010) PER SIDE. DIMENSIONS A AND B DO INCLUDE MOLD MISMATCH AND ARE DETERMINED AT DATUM PLANE -AB-.
- DIMENSION D DOES NOT INCLUDE DAMBAR PROTRUSION. DAMBAR PROTRUSION SHALL NOT CAUSE THE D DIMENSION TO EXCEED 0.520 (0.020).
- MINIMUM SOLDER PLATE THICKNESS SHALL BE 0.0076 (0.0003).
- EXACT SHAPE OF EACH CORNER MAY VARY FROM DEPICTION.

DIM	MILLIMETERS		INCHES	
	MIN	MAX	MIN	MAX
A	7.000	BSC	0.276	BSC
A1	3.500	BSC	0.138	BSC
B	7.000	BSC	0.276	BSC
B1	3.500	BSC	0.138	BSC
C	1.400	1.600	0.055	0.063
D	0.300	0.450	0.012	0.018
E	1.350	1.450	0.053	0.057
F	0.300	0.400	0.012	0.016
G	0.800	BSC	0.031	BSC
H	0.050	0.150	0.002	0.006
J	0.090	0.200	0.004	0.008
K	0.500	0.700	0.020	0.028
M	12°	REF	12°	REF
N	0.090	0.160	0.004	0.006
P	0.400	BSC	0.016	BSC
Q	1°	5°	1°	5°
R	0.150	0.250	0.006	0.010
S	9.000	BSC	0.354	BSC
S1	4.500	BSC	0.177	BSC
V	9.000	BSC	0.354	BSC
V1	4.500	BSC	0.177	BSC
W	0.200	REF	0.008	REF
X	1.000	REF	0.039	REF

Notes

Notes

ON Semiconductor and  are trademarks of Semiconductor Components Industries, LLC (SCILLC). SCILLC reserves the right to make changes without further notice to any products herein. SCILLC makes no warranty, representation or guarantee regarding the suitability of its products for any particular purpose, nor does SCILLC assume any liability arising out of the application or use of any product or circuit, and specifically disclaims any and all liability, including without limitation special, consequential or incidental damages. "Typical" parameters which may be provided in SCILLC data sheets and/or specifications can and do vary in different applications and actual performance may vary over time. All operating parameters, including "Typicals" must be validated for each customer application by customer's technical experts. SCILLC does not convey any license under its patent rights nor the rights of others. SCILLC products are not designed, intended, or authorized for use as components in systems intended for surgical implant into the body, or other applications intended to support or sustain life, or for any other application in which the failure of the SCILLC product could create a situation where personal injury or death may occur. Should Buyer purchase or use SCILLC products for any such unintended or unauthorized application, Buyer shall indemnify and hold SCILLC and its officers, employees, subsidiaries, affiliates, and distributors harmless against all claims, costs, damages, and expenses, and reasonable attorney fees arising out of, directly or indirectly, any claim of personal injury or death associated with such unintended or unauthorized use, even if such claim alleges that SCILLC was negligent regarding the design or manufacture of the part. SCILLC is an Equal Opportunity/Affirmative Action Employer.

PUBLICATION ORDERING INFORMATION

NORTH AMERICA Literature Fulfillment:

Literature Distribution Center for ON Semiconductor
P.O. Box 5163, Denver, Colorado 80217 USA
Phone: 303-675-2175 or 800-344-3860 Toll Free USA/Canada
Fax: 303-675-2176 or 800-344-3867 Toll Free USA/Canada
Email: ONlit@hibbertco.com
Fax Response Line: 303-675-2167 or 800-344-3810 Toll Free USA/Canada

N. American Technical Support: 800-282-9855 Toll Free USA/Canada

EUROPE: LDC for ON Semiconductor – European Support

German Phone: (+1) 303-308-7140 (M-F 1:00pm to 5:00pm Munich Time)
Email: ONlit-german@hibbertco.com
French Phone: (+1) 303-308-7141 (M-F 1:00pm to 5:00pm Toulouse Time)
Email: ONlit-french@hibbertco.com
English Phone: (+1) 303-308-7142 (M-F 12:00pm to 5:00pm UK Time)
Email: ONlit@hibbertco.com

EUROPEAN TOLL-FREE ACCESS*: 00-800-4422-3781

*Available from Germany, France, Italy, England, Ireland

CENTRAL/SOUTH AMERICA:

Spanish Phone: 303-308-7143 (Mon-Fri 8:00am to 5:00pm MST)
Email: ONlit-spanish@hibbertco.com

ASIA/PACIFIC: LDC for ON Semiconductor – Asia Support

Phone: 303-675-2121 (Tue-Fri 9:00am to 1:00pm, Hong Kong Time)
Toll Free from Hong Kong & Singapore:
001-800-4422-3781
Email: ONlit-asia@hibbertco.com

JAPAN: ON Semiconductor, Japan Customer Focus Center
4-32-1 Nishi-Gotanda, Shinagawa-ku, Tokyo, Japan 141-8549

Phone: 81-3-5740-2745
Email: r14525@onsemi.com

ON Semiconductor Website: <http://onsemi.com>

For additional information, please contact your local Sales Representative.