



SOT23, Low-Cost, Low-Dropout, 3-Terminal Voltage References

General Description

The MAX6125/MAX6141/MAX6145/MAX6150/MAX6160 low-dropout, micropower, three-terminal voltage references offer 2.5V, 4.096V, 4.5V, 5.0V, and adjustable (1.23V to 12.4V) output voltages, respectively. Low, 200mV dropout makes these devices ideal for 3V and 5V systems. Unlike two-terminal references that waste battery current and require an external resistor, the MAX61xx family's supply current is virtually independent of input voltage variations, which translates to longer battery life.

Initial accuracy for these devices is $\pm 1\%$. The output temperature coefficient is typically 15ppm/ $^{\circ}\text{C}$, and guaranteed to be less than 50ppm/ $^{\circ}\text{C}$ (except for the MAX6160). The MAX6125/MAX6141/MAX6145/MAX6150 are available in 3-pin SOT23 and 8-pin SO packages. The MAX6160 is available in 4-pin SOT143 and 8-pin SO packages.

Selector Guide

PART	PRESET OUTPUT VOLTAGE (V)	PACKAGE
MAX6125	2.5	3 SOT23/8 SO
MAX6141	4.096	3 SOT23/8 SO
MAX6145	4.5	3 SOT23/8 SO
MAX6150	5	3 SOT23/8 SO
MAX6160	Adjustable (1.23 to 12.40)	4 SOT143/8 SO

Typical Operating Circuit appears on last page.

Features

- ◆ 3-Pin SOT23 Package (MAX6125/41/45/50)
- ◆ 4-Pin SOT143 Package (MAX6160)
- ◆ Low, 200mV Dropout Voltage
- ◆ 75 μA Supply Current, Independent of Input Voltage
- ◆ 15ppm/ $^{\circ}\text{C}$ Typical Tempco (50ppm/ $^{\circ}\text{C}$ max)
- ◆ Stable for All Capacitive Loads up to 10nF
- ◆ Adjustable Output Voltage from 1.23V to ($V_{\text{IN}} - 0.2\text{V}$) (MAX6160)
- ◆ Optimized for 3V/5V Operation

Applications

3V/5V Systems
 Battery-Powered Systems
 Portable and Hand-Held Equipment
 Data-Acquisition Systems
 Instrumentation and Process Control

Ordering Information

PART	TEMP. RANGE	PIN-PACKAGE	SOT TOP MARK
MAX6125ESA	-40 $^{\circ}\text{C}$ to +85 $^{\circ}\text{C}$	8 SO	—
MAX6125EUR	-40 $^{\circ}\text{C}$ to +85 $^{\circ}\text{C}$	3 SOT23-3	EBAA
MAX6141ESA	-40 $^{\circ}\text{C}$ to +85 $^{\circ}\text{C}$	8 SO	—
MAX6141EUR	-40 $^{\circ}\text{C}$ to +85 $^{\circ}\text{C}$	3 SOT23-3	ECAA

Ordering Information continued on last page.

Pin Configurations

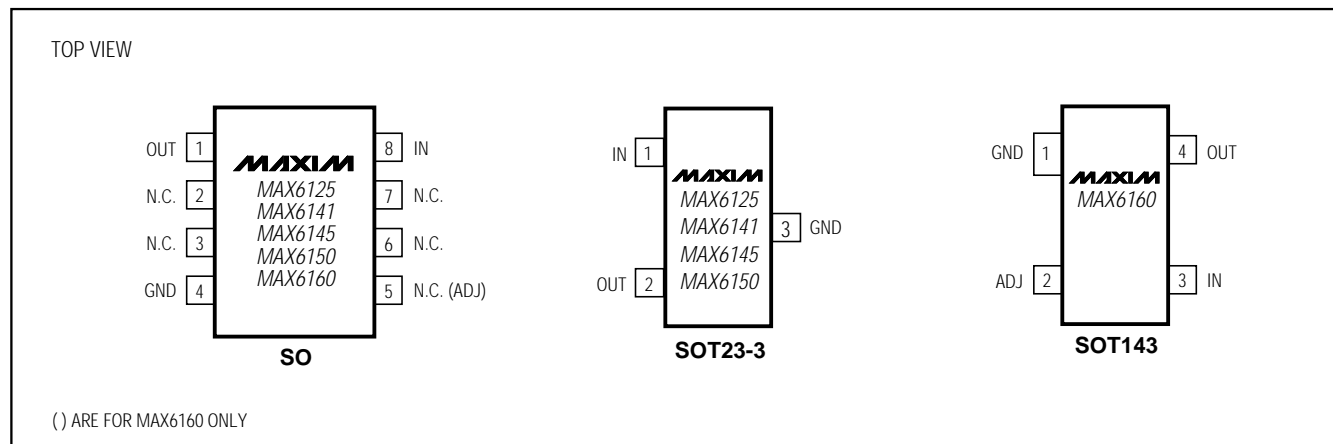

SOT23, Low-Cost, Low-Dropout, 3-Terminal Voltage References

ABSOLUTE MAXIMUM RATINGS

Voltage (with respect to GND)		3-Pin SOT23 (derate 4mW/°C above +70°C).....	320mW
IN.....	-0.3V to +13.5V	4-Pin SOT143 (derate 4mW/°C above +70°C).....	320mW
OUT, ADJ.....	-0.3V to (V _{IN} + 0.3V)	Operating Temperature Range	-40°C to +85°C
Output Short-Circuit Duration (to IN or GND).....	Continuous	Storage Temperature Range	-65°C to +160°C
Continuous Power Dissipation (T _A = +70°C)		Lead Temperature (soldering, 10sec)	+300°C
8-Pin SO (derate 5.9mW/°C above +70°C).....	471mW		

Stresses beyond those listed under "Absolute Maximum Ratings" may cause permanent damage to the device. These are stress ratings only, and functional operation of the device at these or any other conditions beyond those indicated in the operational sections of the specifications is not implied. Exposure to absolute maximum rating conditions for extended periods may affect device reliability.

ELECTRICAL CHARACTERISTICS—MAX6125

(V_{IN} = 2.7V, I_{OUT} = 0mA, T_A = +25°C, unless otherwise noted.) (Note 1)

PARAMETER	SYMBOL	CONDITIONS	MIN	TYP	MAX	UNITS
Supply Voltage	V _{IN}	T _A = T _{MIN} to T _{MAX}	2.7		12.6	V
Output Voltage	V _{OUT}	T _A = +25°C	2.475	2.500	2.525	V
		T _A = T _{MIN} to T _{MAX}	2.450		2.550	
Output Voltage Temperature Coefficient	TCV _{OUT}	T _A = T _{MIN} to T _{MAX}		15	50	ppm/°C
Output Voltage Noise	e _n	0.1Hz to 10Hz		15		μVp-p
		10Hz to 10kHz		500		
Line Regulation	ΔV _{OUT} /ΔV _{IN}	V _{IN} = 2.7V to 12.6V, T _A = T _{MIN} to T _{MAX}		1	50	μV/V
Load Regulation	ΔV _{OUT} /ΔI _{OUT}	I _{SOURCE} = 0mA to 1mA		0.4	1	mV/mA
		I _{SINK} = 0mA to 1mA		1.15	10	
Quiescent Supply Current	I _Q	T _A = +25°C		75	100	μA
		T _A = T _{MIN} to T _{MAX}			130	
Change in Supply Current vs. Change in Input Voltage	ΔI _Q /ΔV _{IN}	V _{IN} = 2.7V to 12.6V		1.7	6	μA/V

ELECTRICAL CHARACTERISTICS—MAX6141

(V_{IN} = 4.3V, I_{OUT} = 0mA, T_A = +25°C, unless otherwise noted.) (Note 1)

PARAMETER	SYMBOL	CONDITIONS	MIN	TYP	MAX	UNITS
Supply Voltage	V _{IN}	T _A = T _{MIN} to T _{MAX}	4.3		12.6	V
Output Voltage	V _{OUT}	T _A = +25°C	4.055	4.096	4.140	V
		T _A = T _{MIN} to T _{MAX}	4.015		4.180	
Output Voltage Temperature Coefficient	TCV _{OUT}	T _A = T _{MIN} to T _{MAX}		15	50	ppm/°C
Output Voltage Noise	e _n	0.1Hz to 10Hz		25		μVp-p
		10Hz to 10kHz		700		
Line Regulation	ΔV _{OUT} /ΔV _{IN}	V _{IN} = 4.3V to 12.6V, T _A = T _{MIN} to T _{MAX}		2	50	μV/V
Load Regulation	ΔV _{OUT} /ΔI _{OUT}	I _{SOURCE} = 0mA to 1mA		0.55	1.6	mV/mA
		I _{SINK} = 0mA to 1mA		1.65	16	
Quiescent Supply Current	I _Q	T _A = +25°C		78	105	μA
		T _A = T _{MIN} to T _{MAX}			130	
Change in Supply Current vs. Change in Input Voltage	ΔI _Q /ΔV _{IN}	V _{IN} = 4.3V to 12.6V		1.7	6	μA/V

SOT23, Low-Cost, Low-Dropout, 3-Terminal Voltage References

MAX6125/MAX6141/MAX6145/MAX6150/MAX6160

ELECTRICAL CHARACTERISTICS—MAX6145

($V_{IN} = 4.7V$, $I_{OUT} = 0mA$, $T_A = +25^{\circ}C$, unless otherwise noted.) (Note 1)

PARAMETER	SYMBOL	CONDITIONS	MIN	TYP	MAX	UNITS
Supply Voltage	V_{IN}	$T_A = T_{MIN}$ to T_{MAX}	4.7		12.6	V
Output Voltage	V_{OUT}	$T_A = +25^{\circ}C$	4.455	4.500	4.545	V
		$T_A = T_{MIN}$ to T_{MAX}	4.410		4.590	
Output Voltage Temperature Coefficient	TCV_{OUT}	$T_A = T_{MIN}$ to T_{MAX}		15	50	ppm/ $^{\circ}C$
Output Voltage Noise	e_n	0.1Hz to 10Hz		30		$\mu Vp-p$
		10Hz to 10kHz		800		
Line Regulation	$\Delta V_{OUT}/\Delta V_{IN}$	$V_{IN} = 4.7V$ to $12.6V$, $T_A = T_{MIN}$ to T_{MAX}		2	50	$\mu V/V$
Load Regulation	$\Delta V_{OUT}/\Delta I_{OUT}$	$I_{SOURCE} = 0mA$ to $1mA$		0.6	1.8	mV/mA
		$I_{SINK} = 0mA$ to $1mA$		1.75	18	
Quiescent Supply Current	I_Q	$T_A = +25^{\circ}C$		79	105	μA
		$T_A = T_{MIN}$ to T_{MAX}			130	
Change in Supply Current vs. Change in Input Voltage	$\Delta I_Q/\Delta V_{IN}$	$V_{IN} = 4.7V$ to $12.6V$		1.7	6	$\mu A/V$

ELECTRICAL CHARACTERISTICS—MAX6150

($V_{IN} = 5.2V$, $I_{OUT} = 0mA$, $T_A = +25^{\circ}C$, unless otherwise noted.) (Note 1)

PARAMETER	SYMBOL	CONDITIONS	MIN	TYP	MAX	UNITS
Supply Voltage	V_{IN}	$T_A = T_{MIN}$ to T_{MAX}	5.2		12.6	V
Output Voltage	V_{OUT}	$T_A = +25^{\circ}C$	4.950	5.000	5.050	V
		$T_A = T_{MIN}$ to T_{MAX}	4.900		5.100	
Output Voltage Temperature Coefficient	TCV_{OUT}	$T_A = T_{MIN}$ to T_{MAX}		15	50	ppm/ $^{\circ}C$
Output Voltage Noise	e_n	0.1Hz to 10Hz		35		$\mu Vp-p$
		10Hz to 10kHz		900		
Line Regulation	$\Delta V_{OUT}/\Delta V_{IN}$	$V_{IN} = 5.2V$ to $12.6V$, $T_A = T_{MIN}$ to T_{MAX}		1	50	$\mu V/V$
Load Regulation	$\Delta V_{OUT}/\Delta I_{OUT}$	$I_{SOURCE} = 0mA$ to $1mA$		0.65	2	mV/mA
		$I_{SINK} = 0mA$ to $1mA$		1.9	20	
Quiescent Supply Current	I_Q	$T_A = +25^{\circ}C$		80	110	μA
		$T_A = T_{MIN}$ to T_{MAX}			145	
Change in Supply Current vs. Change in Input Voltage	$\Delta I_Q/\Delta V_{IN}$	$V_{IN} = 5.2V$ to $12.6V$		1.7	6	$\mu A/V$

SOT23, Low-Cost, Low-Dropout, 3-Terminal Voltage References

ELECTRICAL CHARACTERISTICS—MAX6160

($V_{IN} = 2.7V$; $I_{OUT} = 0mA$; $R1 = 215k\Omega \pm 0.1\%$, $R2 = 208k\Omega \pm 0.1\%$ (circuit of Figure 1); $T_A = +25^\circ C$; unless otherwise noted.) (Notes 1, 2)

PARAMETER	SYMBOL	CONDITIONS	MIN	TYP	MAX	UNITS
Supply Voltage	V_{IN}	$T_A = T_{MIN}$ to T_{MAX}	2.7		12.6	V
Output Voltage Range		$T_A = T_{MIN}$ to T_{MAX}	1.23		$V_{IN} - 0.2$	V
Output Voltage	V_{OUT}	$T_A = +25^\circ C$	2.475	2.500	2.525	V
		$T_A = T_{MIN}$ to T_{MAX}	2.450		2.550	
ADJ Feedback Voltage Threshold	V_{ADJ}			1.23		V
ADJ Input Current	I_{ADJ}	$V_{ADJ} = 1.23V$		70		nA
Output Voltage Temperature Coefficient	TCV_{OUT}	$T_A = T_{MIN}$ to T_{MAX}		15	100	ppm/ $^\circ C$
Output Voltage Noise	e_n	0.1Hz to 10Hz		15		$\mu Vp-p$
		10Hz to 10kHz		500		
Line Regulation	$\Delta V_{OUT}/\Delta V_{IN}$	$V_{IN} = 2.7V$ to $12.6V$, $T_A = T_{MIN}$ to T_{MAX}		1	50	$\mu V/V$
Load Regulation	$\Delta V_{OUT}/\Delta I_{OUT}$	$I_{SOURCE} = 0mA$ to $1mA$		0.35	1	mV/mA
		$I_{SINK} = 0mA$ to $1mA$		1.15	10	
Quiescent Supply Current	I_Q	$T_A = +25^\circ C$		75	100	μA
		$T_A = T_{MIN}$ to T_{MAX}			130	
Change in Supply Current vs. Change in Input Voltage	$\Delta I_Q/\Delta V_{IN}$	$V_{IN} = 2.7V$ to $12.6V$		1.7	6	$\mu A/V$

Note 1: All devices are 100% production tested at $T_A = +25^\circ C$, and are guaranteed by design for $T_A = T_{MIN}$ to T_{MAX} as specified.

Note 2: R1 and R2 program the output voltage in the 1.23V to ($V_{IN} - 0.2V$) range (see the section *Setting the MAX6160 Output Voltage*).

Typical Operating Characteristics

($V_{IN} = V_{IN(MIN)}$, $I_{OUT} = 0mA$, $T_A = +25^\circ C$, unless otherwise noted.)

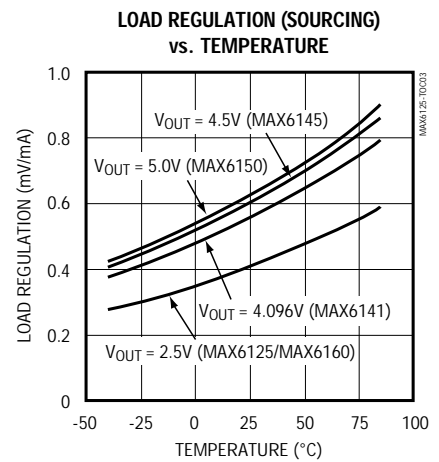
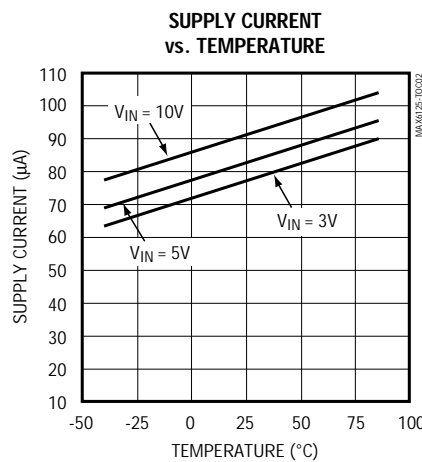
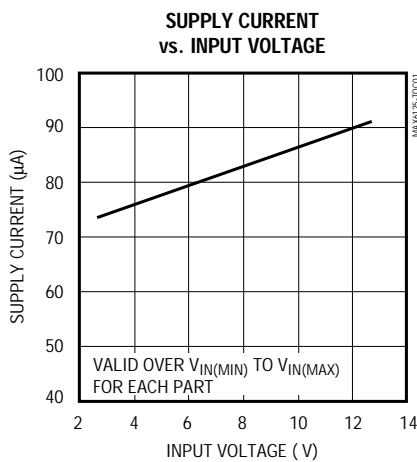

SOT23, Low-Cost, Low-Dropout, 3-Terminal Voltage References

Typical Operating Characteristics (continued)

($V_{IN} = V_{IN(MIN)}$, $I_{OUT} = 0\text{mA}$, $T_A = +25^\circ\text{C}$, unless otherwise noted.)

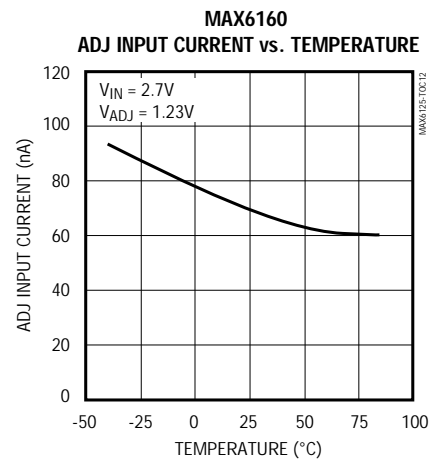
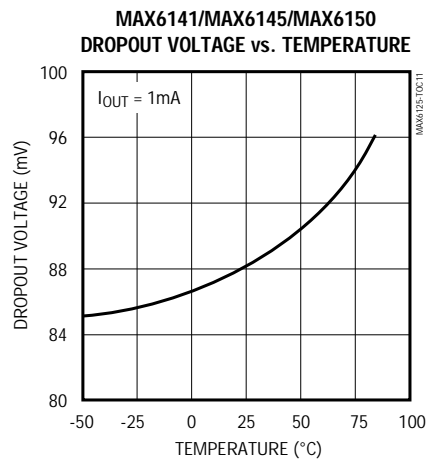
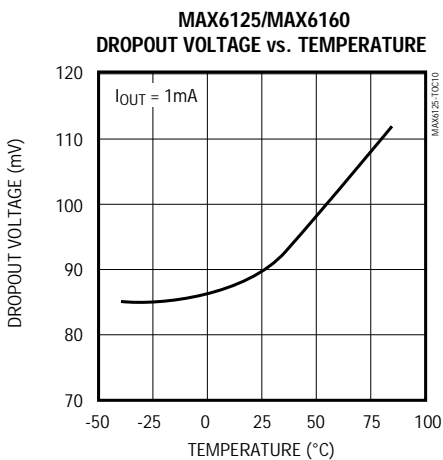
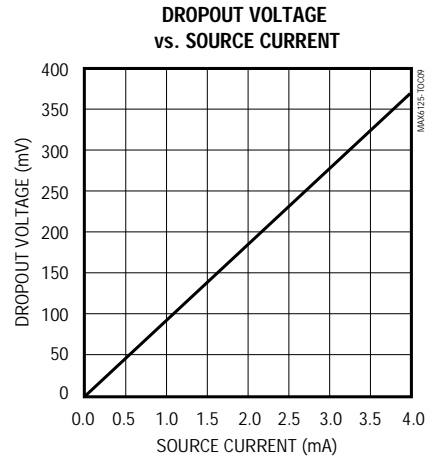
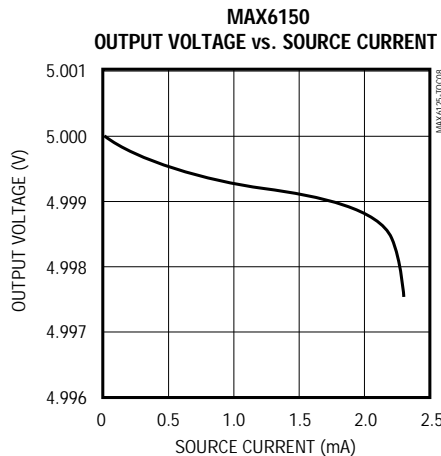
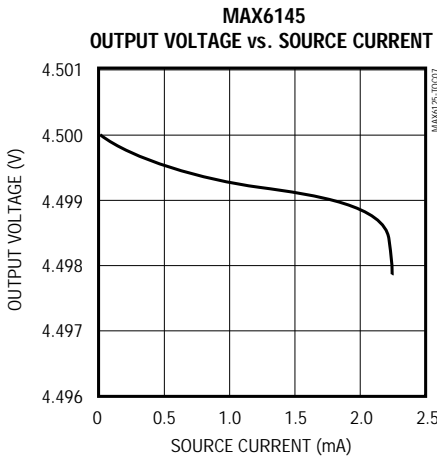
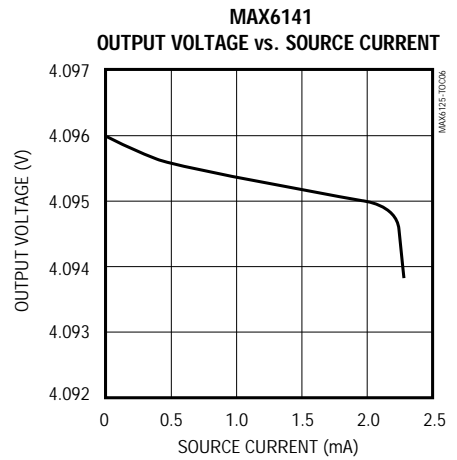
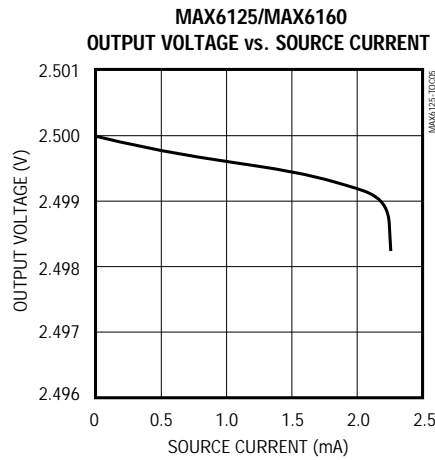
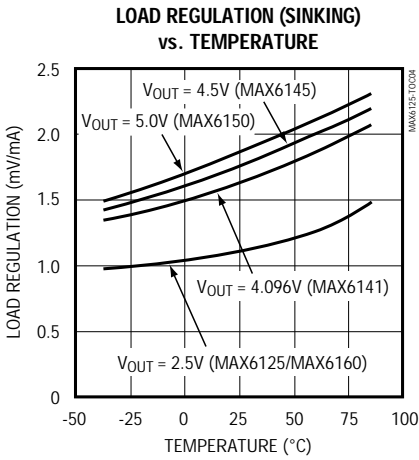

MAX6125/MAX6141/MAX6145/MAX6150/MAX6160

SOT23, Low-Cost, Low-Dropout, 3-Terminal Voltage References

Typical Operating Characteristics (continued)

($V_{IN} = V_{IN(MIN)}$, $I_{OUT} = 0mA$, $T_A = +25^{\circ}C$, unless otherwise noted.)

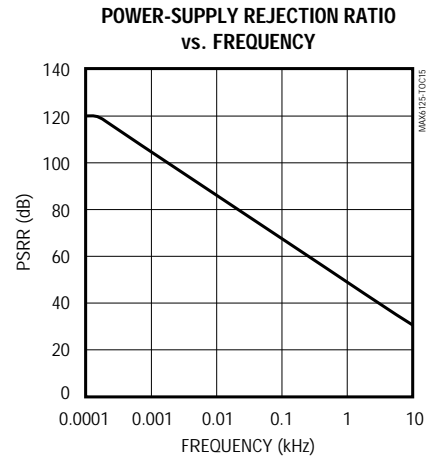
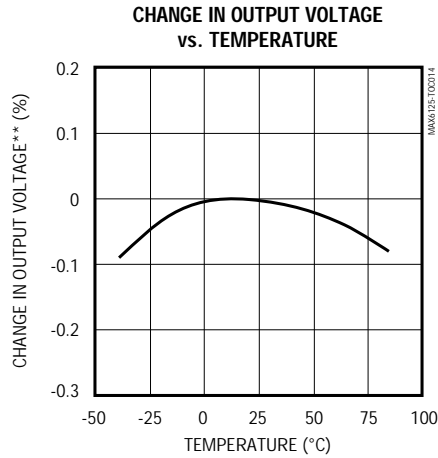
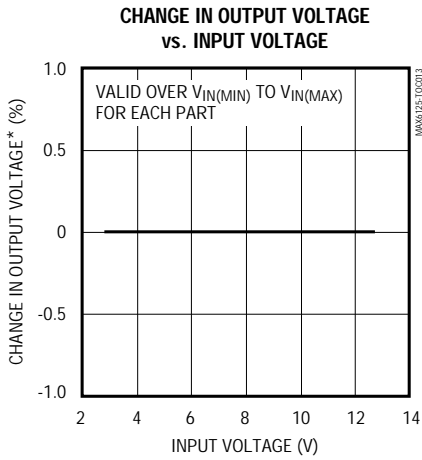

*With respect to output voltage at $V_{IN} = V_{IN(MIN)}$.

**With respect to output voltage at $T_A = +25^{\circ}C$.

MAX6125
LOAD-TRANSIENT RESPONSE (SINKING)

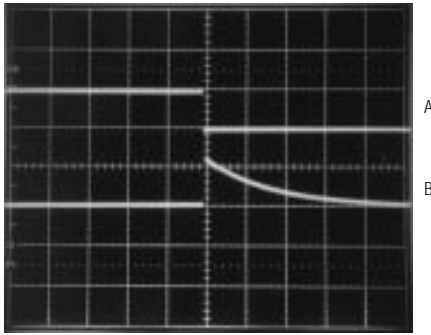

10µs/div
A = OUTPUT CURRENT, 1mA/div, $I_{OUT} = 0mA$ to -1mA
B = OUTPUT VOLTAGE, 200mV/div

MAX6125
LOAD-TRANSIENT RESPONSE (SOURCING)

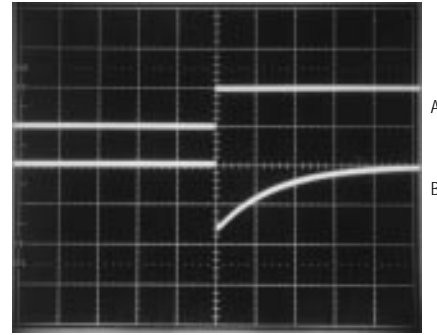

10µs/div
A = OUTPUT CURRENT, 1mA/div, $I_{OUT} = 0mA$ to 1mA
B = OUTPUT VOLTAGE, 50mV/div

MAX6125
LINE-TRANSIENT RESPONSE

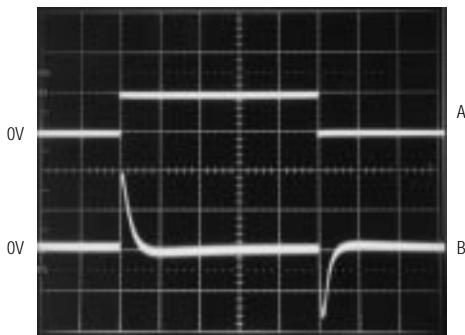

5µs/div
A = INPUT VOLTAGE, 100mV/div, $V_{IN} = 3V \pm 50mV$
B = OUTPUT VOLTAGE, 20mV/div

MAX6125
0.1Hz TO 100Hz NOISE

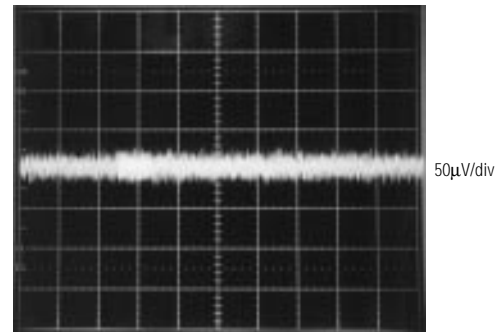

1sec/div

SOT23, Low-Cost, Low-Dropout, 3-Terminal Voltage References

Pin Description

PIN			NAME	FUNCTION
SO	SOT23-3	SOT143		
1	2	4	OUT	Reference Output
2, 3, 5*, 6, 7	—	—	N.C.	No Connection. Not internally connected.
4	3	1	GND	Ground
5**	—	2	ADJ	Adjustable output voltage feedback input. Connect a resistor divider between OUT, ADJ, and GND (Figure 1).
8	1	3	IN	Input Voltage

*Except MAX6160.

**MAX6160 only.

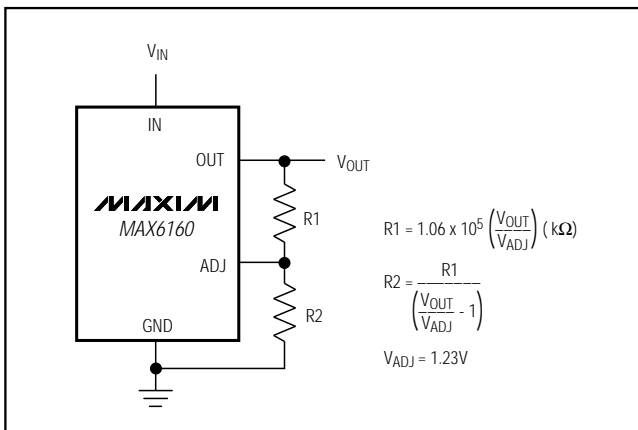

Figure 1. MAX6160 Adjustable Output Circuit

Applications Information

Setting the MAX6160 Output Voltage

Set the output voltage on the MAX6160 by connecting a resistor divider between OUT, ADJ, and GND (Figure 1). Choose R1 according to the following equation:

$$R1 = (1.06 \times 10^5) (V_{OUT} / V_{ADJ})(k\Omega)$$

where $V_{TH} = 1.23V$. The scaling factor (1.06×10^5) compensates for the MAX6160's change in ADJ input current over temperature. When R1 is chosen correctly, the change in voltage across R1 caused by the ADJ input current is properly cancelled. Choose R1 to within

$\pm 5\%$ of this calculated value (nearest standard value plus specified resistor tolerance) to optimize the output voltage temperature coefficient. Using $R1 = 215k\Omega$:

$$R2 = 215k\Omega \left(\frac{2.5V}{1.23V} - 1 \right) \approx 208k\Omega,$$

which is also the nearest 0.1% resistor value.

Choose R2 according to the following equation:

$$R2 = R1 / (V_{OUT} / V_{ADJ} - 1)$$

For example, a 2.5V output requires $R1 = (1.06 \times 10^5) (2.5V / 1.23V) \approx 215\Omega$, which is the nearest standard-value 0.1% resistor.

Input Bypassing

For the best line-transient performance, decouple the input with a $0.1\mu F$ ceramic capacitor, as shown in the *Typical Operating Circuit*. Locate the capacitor as close to the device pin as possible. Where transient performance is less important, no capacitor is necessary.

Output Bypassing

The MAX6125/MAX6141/MAX6145/MAX6150/MAX6160 do not require an output capacitor. They are stable for capacitive loads from 0nF to 10nF. If your application requires an output charge reservoir (e.g., to decouple the reference from a DAC's input), then make sure that the total output capacitive load does not exceed 10nF for optimum settling-time performance.

MAX6125/MAX6141/MAX6145/MAX6150/MAX6160

SOT23, Low-Cost, Low-Dropout, 3-Terminal Voltage References

MAX6125/MAX6141/MAX6145/MAX6150/MAX6160

Ordering Information (continued)

PART	TEMP. RANGE	PIN-PACKAGE	SOT TOP MARK
MAX6145ESA	-40°C to +85°C	8 SO	—
MAX6145EUR	-40°C to +85°C	3 SOT23-3	EDAA
MAX6150ESA	-40°C to +85°C	8 SO	—
MAX6150EUR	-40°C to +85°C	3 SOT23-3	EEAA
MAX6160ESA	-40°C to +85°C	8 SO	—
MAX6160EUS	-40°C to +85°C	4 SOT143	JXAA

Chip Information

TRANSISTOR COUNT: 42

Typical Operating Circuit

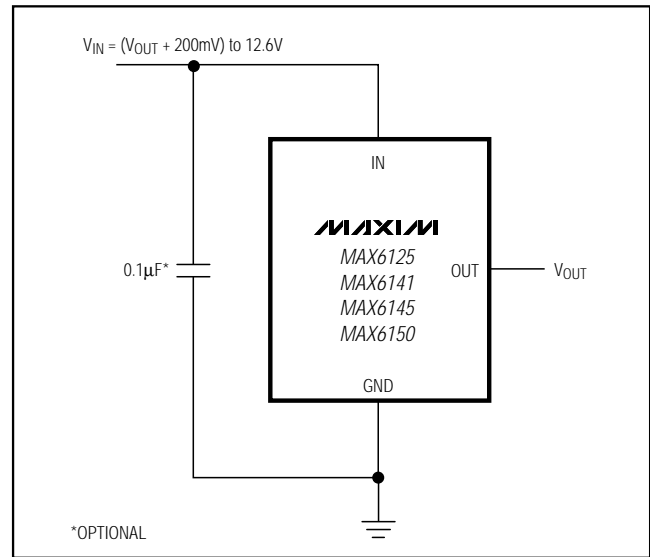

Package Information

DIM	INCHES		MILLIMETERS	
	MIN	MAX	MIN	MAX
A	0.031	0.047	0.787	1.194
A1	0.001	0.005	0.025	0.127
B	0.014	0.022	0.356	0.559
C	0.0034	0.006	0.086	0.152
D	0.105	0.120	2.667	3.048
E	0.047	0.055	1.194	1.397
e	0.070	0.080	1.778	2.032
H	0.082	0.098	2.083	2.489
L	0.004	0.012	0.102	0.305
S	0.017	0.022	0.432	0.559
α	0°	8°	0°	8°

21-0051B

**3-PIN SOT23-3
SMALL-OUTLINE
TRANSISTOR PACKAGE**

Maxim cannot assume responsibility for use of any circuitry other than circuitry entirely embodied in a Maxim product. No circuit patent licenses are implied. Maxim reserves the right to change the circuitry and specifications without notice at any time.

8 Maxim Integrated Products, 120 San Gabriel Drive, Sunnyvale, CA 94086 (408) 737-7600