



# Evaluation Board for Microprocessor System Temperature Monitor

## Preliminary Technical Data

## EVAL - ADM1023

### FEATURES

Next Generation upgrade to the ADM1021  
On-Chip and Remote Temperature Sensing  
Offset Registers for System Calibration  
1°C Accuracy and Resolution on Local Channel  
0.125°C Resolution/1°C Accuracy on Remote Channel  
Programmable Over/Under Temperature Limits  
Programmable Conversion Rate  
2-Wire SMBus Serial Interface  
Supports System Management Bus (SMBus™) Alert  
160µA Max Operating Current  
3µA Standby Current  
3V to 5.5V Supply  
Small 16-Lead QSOP Package

### APPLICATIONS

Desktop Computers  
Notebook Computers  
Smart Batteries  
Industrial Controllers  
Telecoms Equipment  
Instrumentation

### INTRODUCTION

The ADM1023 Evaluation Board allows the ADM1023 microprocessor system temperature IC to be quickly and easily evaluated using a personal computer. Using the evaluation board and its accompanying software the ADM1023 can be interfaced to any personal computer running Windows™ 95 or Windows™ 98, via the computer's parallel printer port.

The evaluation board allows the input and output functions of the ADM1023 to be exercised without the need for external components. The software allows control and monitoring of the ADM1023's internal registers.

### THE ADM1023

The following is a brief description of the ADM1023 and a system overview. Further information can be found in the datasheet for the device.

The ADM1023 is a hardware temperature monitor for personal computers and other microprocessor systems which features a two-channel digital thermometer and over/under temperature alarm.

The device can measure the temperature of a microprocessor using on-chip diode connected transistor or can use a low cost small signal transistor such as the 2N3904 or the 2N3906. The measurement technique cancels the absolute value of the transistor's base emitter voltage, so that no calibration is required.

### EVALUATION SYSTEM PACKAGE CONTENTS

The evaluation system contains the following items

- This application note
- ADM1023 Evaluation Board
- Centronics Cable
- Evaluation Software on 3 floppy disks

### EVALUATION BOARD HARDWARE

The ADM1023 evaluation board contains the following main components which can be identified from the block diagram, printed circuit board silk screen and schematic diagram of figures 1, 2 and 3 overleaf.

- ADM1023 IC
- NPN sensor transistor
- LED indicators for power and Alert
- Jumpers for selecting sensor and for setting SMBus address
- Interface buffers
- Connector for parallel interface
- Test connector for connecting to CPU Transistor

REV. A 11/10/99

Information furnished by Analog Devices is believed to be accurate and reliable. However, no responsibility is assumed by Analog Devices for its use, nor for any infringements of patents or other rights of third parties which may result from its use. No license is granted by implication or otherwise under any patent or patent rights of Analog Devices.

™Windows is a registered trademark of Microsoft Corporation  
One Technology Way, P.O. Box 9106, Norwood, MA 02062-9106, U.S.A.  
Tel: 781/329-4700 World Wide Web Site: <http://www.analog.com>  
Fax: 781/326-8703 Analog Devices, Inc., 1998

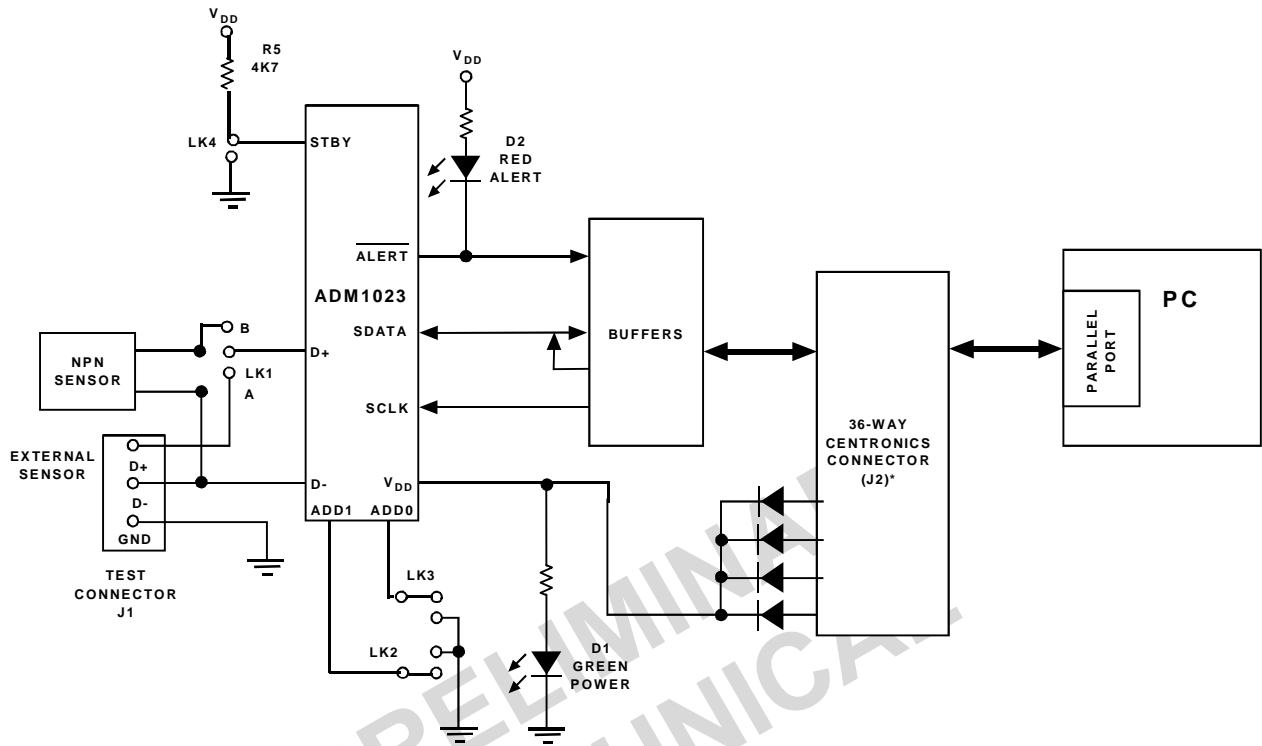

Figure 1. ADM1023 Evaluation Board Block Diagram

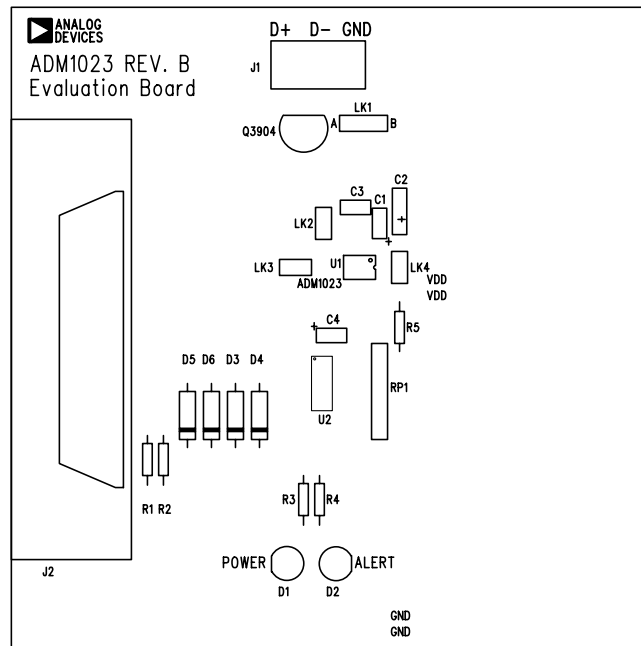

Figure 2. ADM1023 Evaluation Board SilkScreen



**CONNECTORS, SWITCHES AND INDICATORS**

The function of the various connectors, links and indicators on the evaluation board are explained below.

**TEST CONNECTOR**

Test Connector J1 allows an external diode to be connected between the D+ and D- terminals of the ADM1023

**CENTRONICS INTERFACE CABLE**

The evaluation board and the personal computer may be connected via the printer parallel port using the contronics cable provided. The connections to J2 are as follows.

**REMOTE SENSOR SELECT LK1**

The function of this jumper is to allow the user to choose between measuring temperature using the on-board remote sensor and an external one connected between the D+ and D- terminals of J1. When the middle pin is linked to B the on-board sensor is used and when the middle pin is linked to A the off-board sensor is used.

**TABLE 1. ADM1023 SENSOR SELECTION**

LK1 Position	Sensor Selected
A	External Sensor
B	On-board NPN Sensor

**SERIAL BUS ADDRESS SELECT**

LK2 and LK3 are used to set the two LSB's of the ADM1023's serial bus address, ADD0 and ADD1. These pins are tri-state and can be grounded, left unconnected or tied to  $V_{DD}$ . This means a total of nine addresses are possible. However for simplicity on the evaluation board a jumper is used to allow each pin two states ( 4 Addresses). The pin is floating when the shorting link is not on the board. The pin is grounded when the shorting link is placed on the board. It should be noted that ADD0 and ADD1 are only read at power up. If LK2 or LK3 are changed while the ADM1023 is on, the change of address will not be effective until the device has been powered off and then on again.

As the serial bus address is seven bits, when storing it as an 8-bit word it must be left or right justified, with either the MSB or the LSB of the 8-bit word as zero. The ADM1023 evaluation software stores the 7-bit serial bus address as left justified and makes the LSB zero. Table 2 shows the four possible addresses possible on the evaluation board

**TABLE 2. ADM1023 DEVICE ADDRESSES**

Address Pins		Device Address	
ADD1 (LK2)	ADD0 (LK3)	Binary	Hex
0(LK2 Closed)	0(LK3 Closed)	0011000(0)	0
0(LK Closed)	NC(LK Open)	0011001(0)	32
NC(LK2 Open)	0(LK3 Closed)	0101001(0)	52
NC(LK2 Open)	NC(LK3 Open)	0101010(0)	54

**STANDBY INPUT LK4**

The ADM1023 has an active low standby input, pin 15 controlled by LK4 on the evaluation board. This is a logic input that enables selection between normal operation (high) and standby operation (low). Without the shorting link the pin is high (normal mode). With the shorting link the pin is low (standby mode). This input performs the same function as bit 7 of the status register

**THE SOFTWARE**

The software allows the ADM1023's functions to be controlled from the PC via an easy to use interface operating under the Windows™ environment. The contents of the devices internal registers can easily be read or altered through a user-friendly graphics interface, while the Control Centre window allows the graphing of the temperature readings.

**INSTALLING THE SOFTWARE**

To install the software, insert the first disk of the program software into drive A, click on the Start icon, click on Run, then type A:setup.exe as the file name. If the 3.5inch floppy disk drive is not drive "A" then type "X" instead of "A" where "X" is the drive letter of the 3.5-inch floppy disk drive.

**USING THE SOFTWARE**

When using the software, first ensure the evaluation board is connected to the Parallel Printer Port.

To start the software, select Start-Programs-Analog Devices-ADM1023 Eval Software.

When the program is started, a startup screen will appear.

Press any key or mouse button to go onto the next step, which is the Software Initialisation Wizard.

Fig 4. Evaluation Software Startup Screen

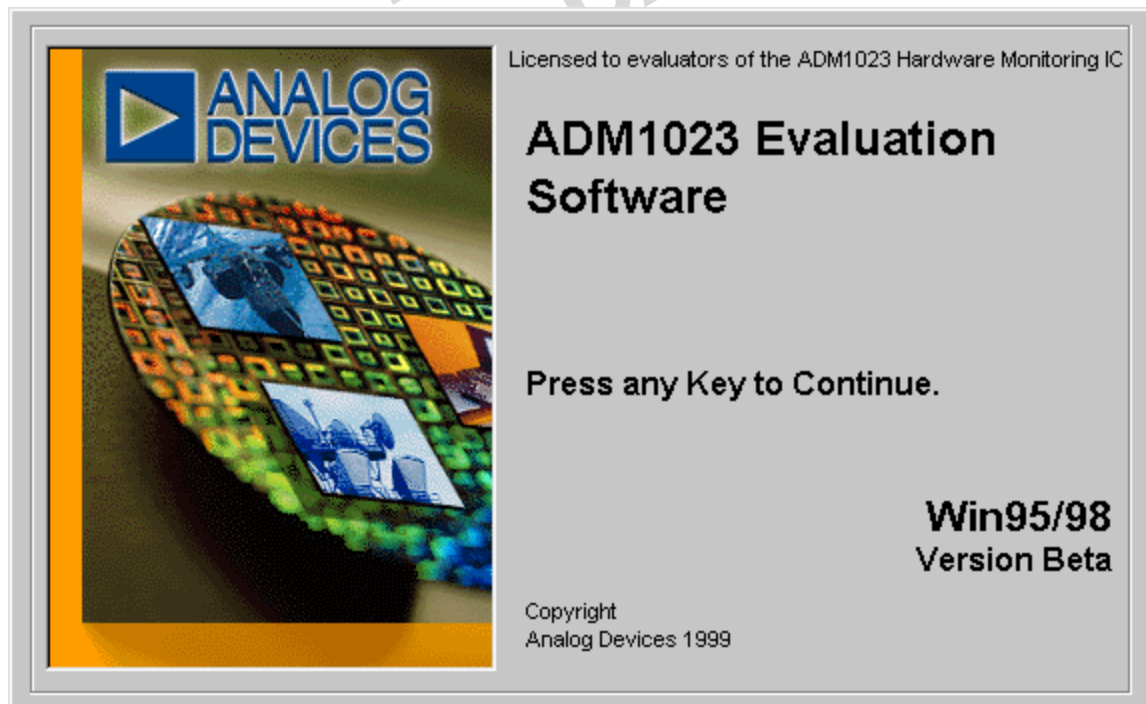

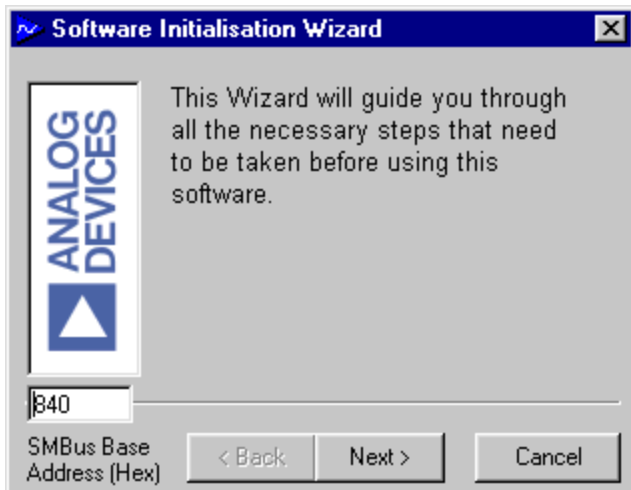

Click on "Next" to go to the next screen, which allows the user to select between connecting the evaluation board via the printer port or via the SMBus. The PIIX4 SMBus Interface is intended for when the ADM1023 is present on the PC's motherboard. While using the evaluation board the Parallel Printer Port Option should always be selected.

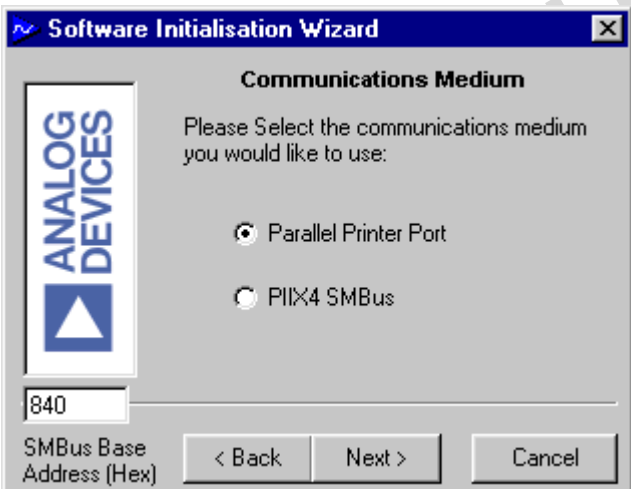

Once the communication medium has been selected, click on "Next" to go to the next screen. When you are ready for the software to begin searching for the evaluation board on either the parallel port or the SMBus, click "Next"

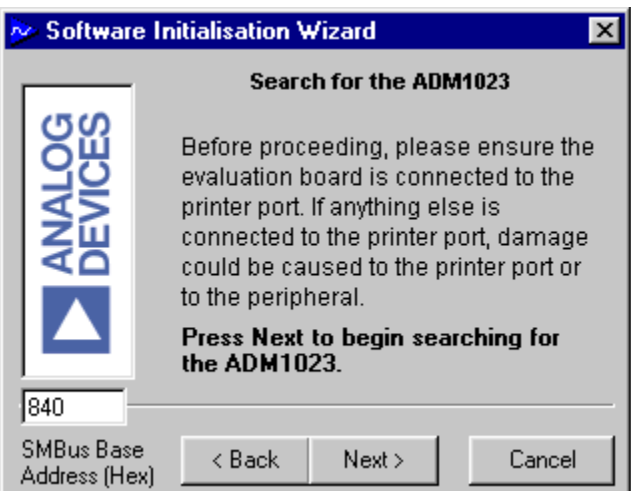

The software will search for the ADM1023 and when it is found the following screen will appear. The device address given will depend on the settings of J7 and J8

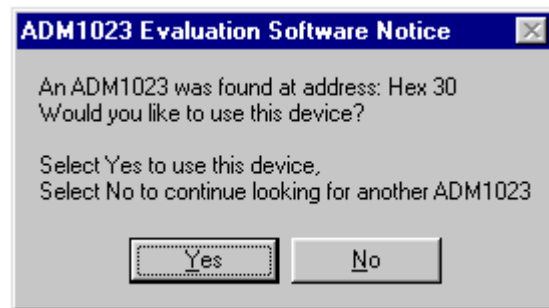

If this is the device the user intends to use, click on "Yes" and the following screen appears. If the user wants to use a different device click on "No" to continue searching.



If the device was not found the following screen will appear. In this case check the connections to the evaluation board, click on "Back" and try again. If this does not work then try re-booting the PC and re-running the software

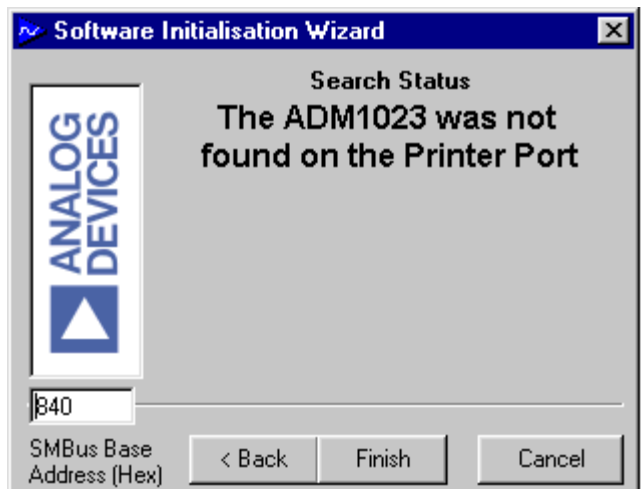

When the software has successfully found the ADM1023, click on "Finish". An index-card type display with three tabs will be displayed on the screen.

The Main Tab shows the software version and allows the user to run the communications setup or quit the program.

It is also possible to quit the program by clicking on 

**READ/WRITE**

This tab displays information about the ADM1023's internal registers and allows their contents to be read and/or altered. Each register has a button associated with it. Clicking on a button will display the contents of the selected register in the register contents box and the name of each register bit. The register contents are also displayed in hexadecimal and decimal.

Clicking on a register button causes its contents to be read once if continuous reading is off. If continuous reading is on, the register contents will be updated continuously. Click the

button to toggle between  and



The type of register selected, its hexadecimal address, its current value in hexadecimal and decimal and the previous value written to the register, are also displayed.

The ADM1023 may be put into standby mode by clicking on the

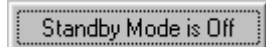
 button, or by setting bit 6 of the Configuration Register. The legend on the button will change to

 and clicking it again will return the

ADM1023 to normal operating mode.

Data may be written to all registers that are Read/Write (refer to data sheet for more information). When the Read/Write tab is first selected, none of the registers have been written to, and they contain their default values.

Registers may be written to in two ways. Clicking on a bit in the Read/Write display will toggle its value between 0 and 1. This is useful where a function is controlled by setting or clearing individual bits in a register, for example, turning standby mode on or off by setting or clearing the Op. Mode bit in the Configuration Register.

The entire contents of a register may be changed by typing a Hex or decimal value in the text boxes of the Write display. The button will change from green to red and the new value can be written to the register by clicking on the button.

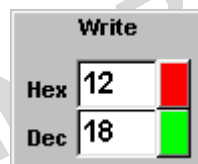

This is useful where a register contains a numeric value such as a temperature limit.

Figure 5. Main Program Tab

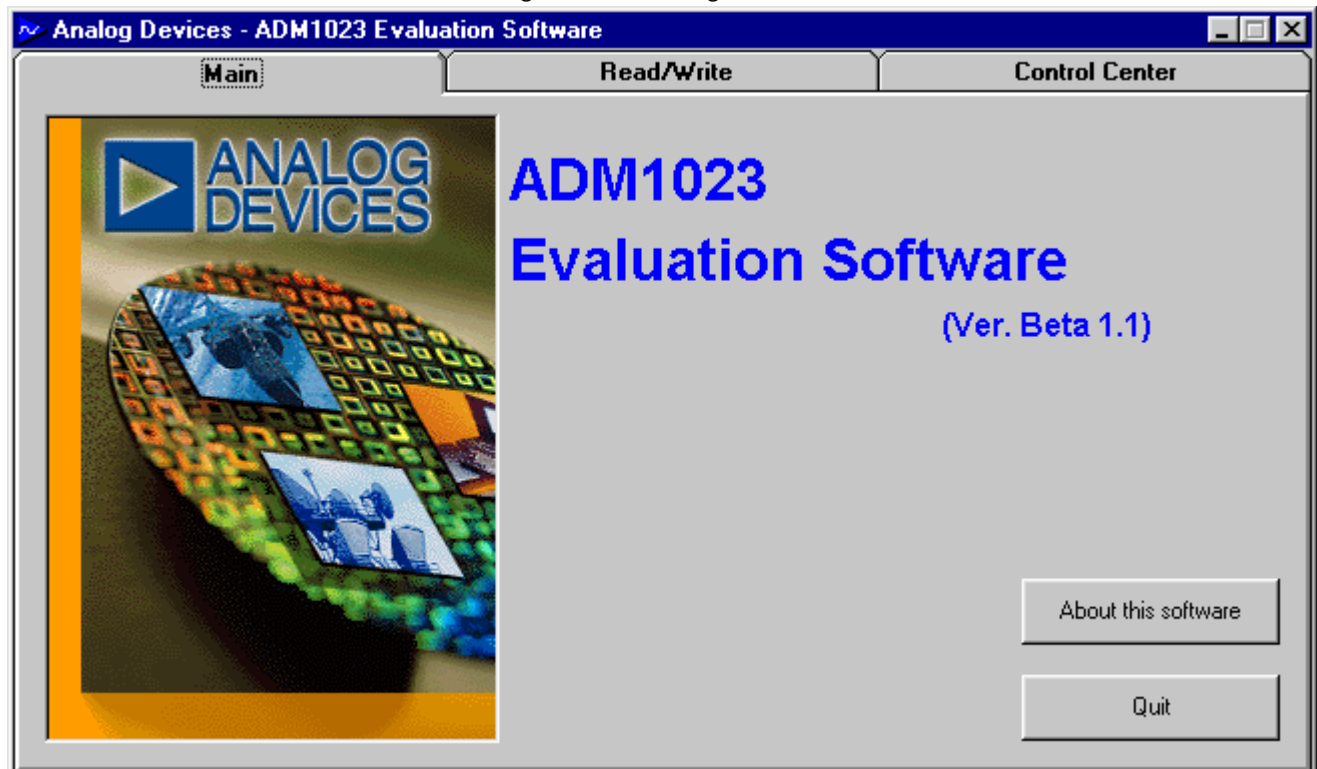

**ONE-SHOT OPERATION**

When the ADM1023 is put into standby mode by setting bit 6 of the Configuration register or clicking on the **Standby Mode is Off** button, a one-shot reading of the remote temperature may be taken by clicking on the **Make One-Shot Measurement** button. The temperature found will then be displayed.

**CONTROL CENTER**

The Control Center tab allows readings to be displayed graphically on bargraphs or line graphs.

**BAR GRAPHS**

At the bottom of the Control Center tab are bargraphs for the local and remote sensors. These can be toggled on and off by clicking on the **Start Bargraphs** button. The legend will change to **Stop Bargraphs** and clicking again will turn off the bargraphs. The high and low temperature limits can be changed by moving the pointer arrows below the bargraphs.

The ADC sampling rate can be changed by rotating the control knob next to the bargraphs.

**ALERT INDICATION**

When the Control Center tab is first selected, the Alert Status Indicator **Alert Status** **Alert Detect Off** is off.

If Alert detection is turned on by clicking on the **Check for Alert** button. The legend will change to

**Don't Check Alert** and the **Alert Status** **No Alert Detected** indicator will become active. It will change from green to red

**Alert Status** **Alert Detected** when the local or remote temperature goes outside limits, and the ALERT LED (D2) on the evaluation board will light. The LED can be turned off by clicking on the

**Clr Alert Hardware Int** button, provided the temperature has gone back within limits, or the limits have been adjusted to be outside the temperature reading. The Alert Status Indicator automatically changes back to green when the temperature is within limits. Alert detection can be turned off again by clicking on **Don't Check Alert**.

Figure 6. Read/Write Program Tab

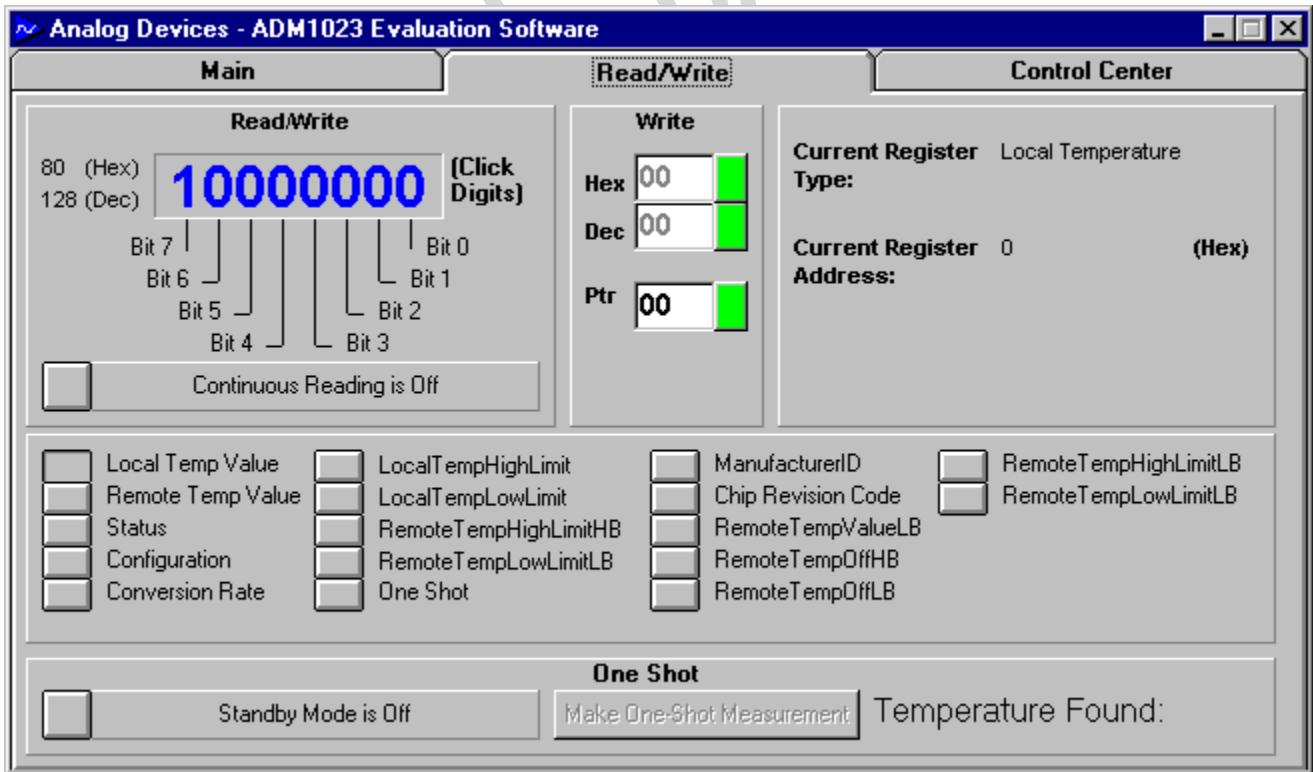



**LINE GRAPHS**

Line graphs of temperature against time can be plotted by clicking on the **Start Graphing** button. The legend will change to **Stop Graphing** and clicking again will stop the graph.

While the graph is displayed on the screen, it is possible to zoom in or out by moving the arrows on the temperature and time axes. Moving the lower arrow up the temperature axis increases the minimum temperature shown on the axis, while moving the upper arrow down decreases the maximum temperature displayed, thus zooming in on a narrower temperature range. Similarly, moving the left arrow to the right on the time axis and/or the right arrow to the left displays a narrower band of time on this axis.

The graph can be cleared by clicking on the **Clear Graph** button.

PRELIMINARY  
TECHNICAL DATA

Figure 7. Control Centre Program Tab

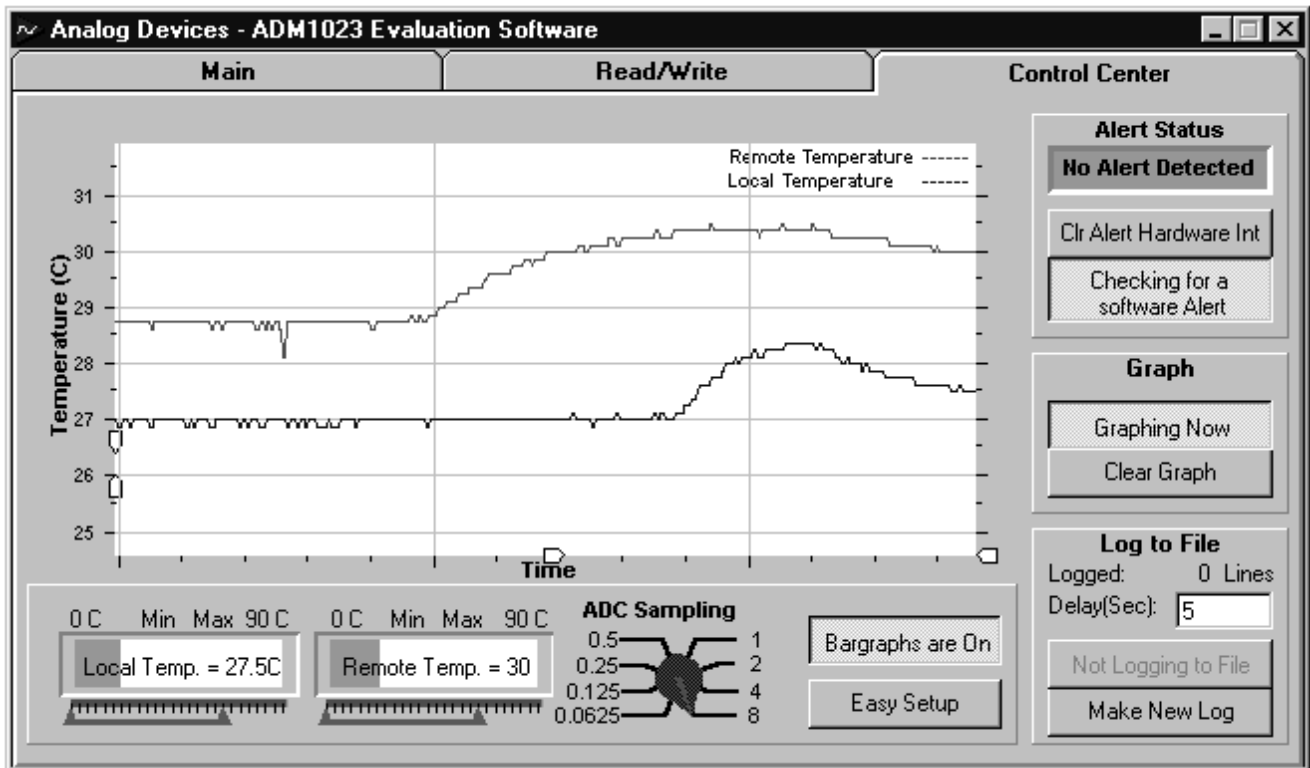

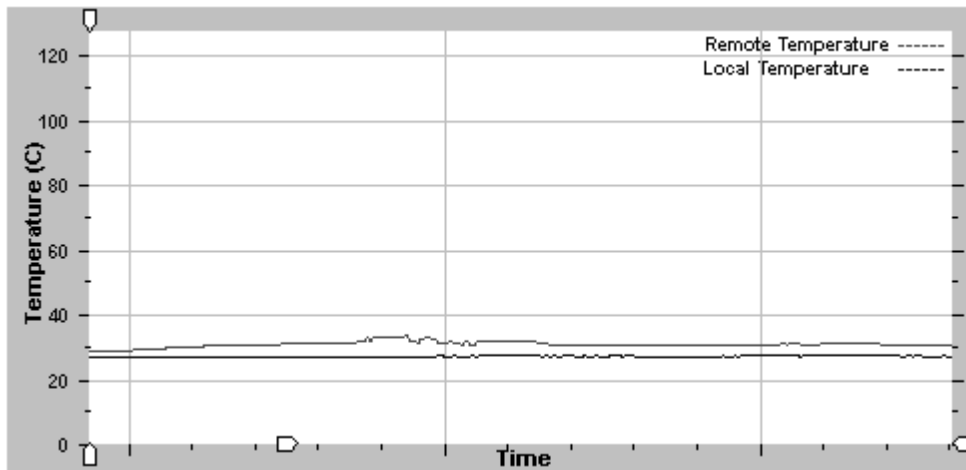

Figure 8. Normal Graph

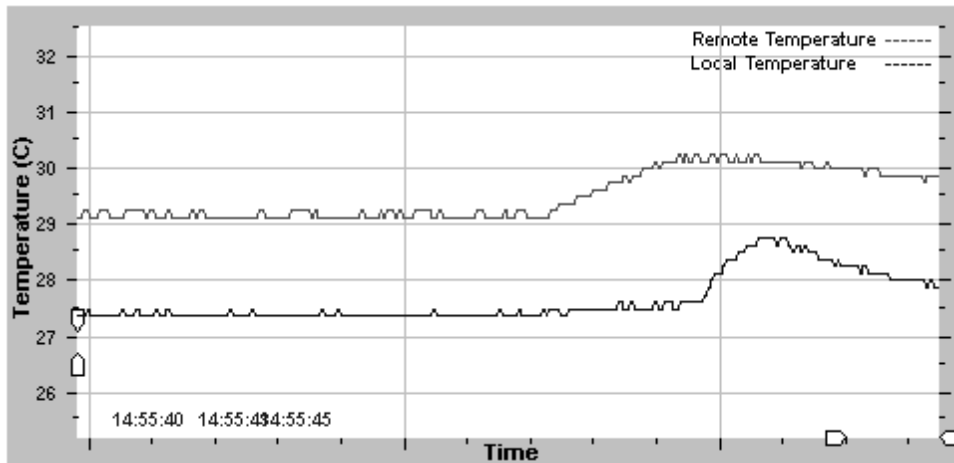
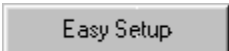

Figure 9. Zoomed In

**EASY SETUP**

The line and bargraphs can be started with a single click by clicking on the  button . This starts the line and bargraphs, sets temperature limits of 0°C and 90°C and turns on the Alert detection.

**LOG TO FILE**

This function allows the user to record the values of the remote and local temperatures to a Microsoft Excel file. The frequency at which values are stored to the file are determined by the delay(sec) window. To change this value, click on the screen and type in the new value in seconds.

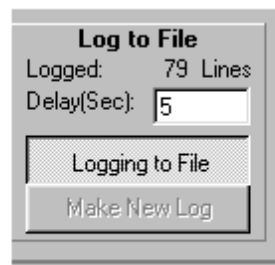

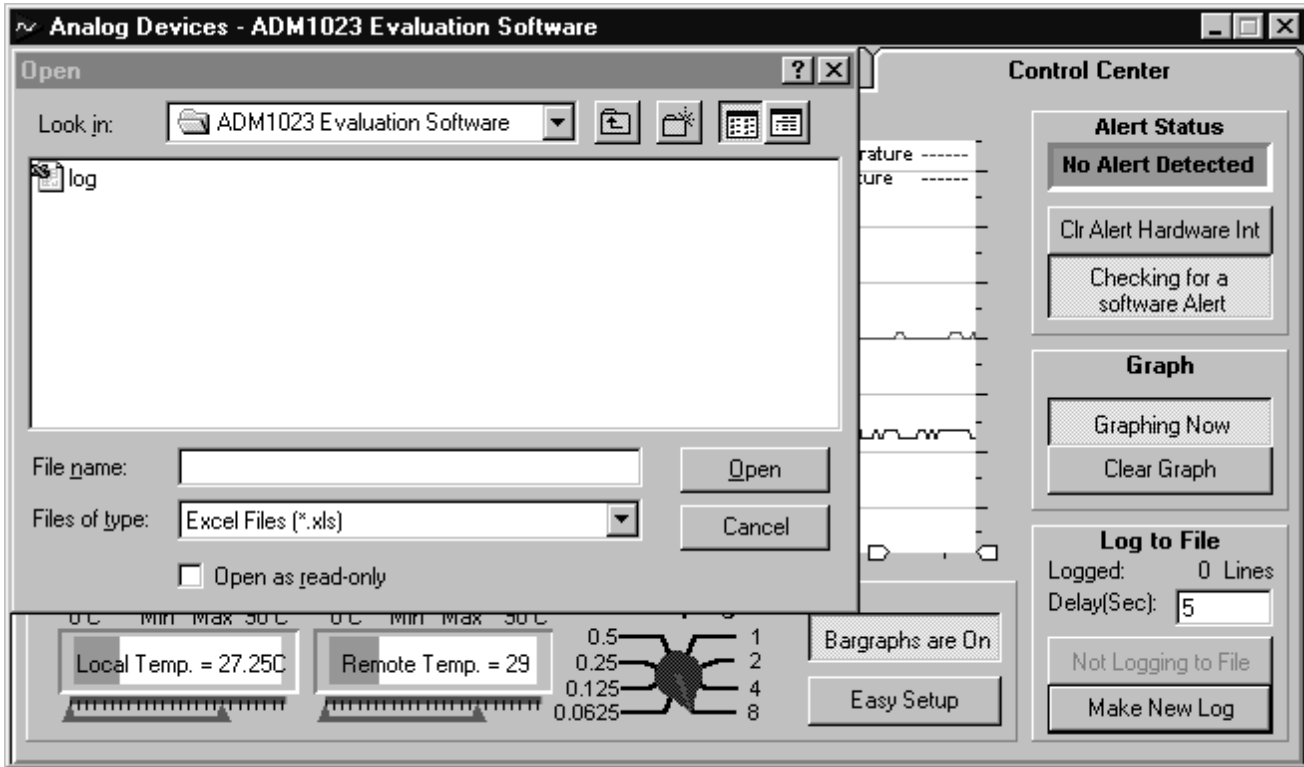

Figure 9. Opening a New Log to File

To start a new Log click on the "Make New Log" button . The above "Open" Box will appear. Type in a name for the file and click "Open". The program will begin storing the values of both the remote and local temperatures to the file at the chosen intervals. The number of lines logged will be displayed on the Control Centre Window. To stop writing to the file click on the "Not Logging to file" button.

To view this table open the document using Microsoft Excel.

**ABOUT MENU**

The About Menu on the main menu tab gives information about the software and contains the copyright notice

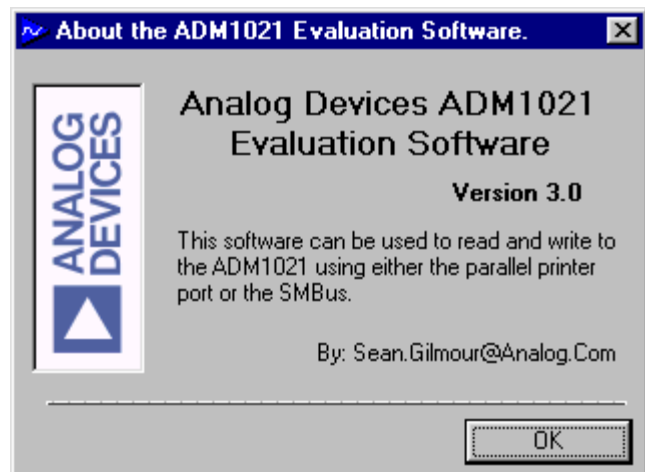

Figure 10. About Menu

## APPENDIX B. COMPONENT LIST

**Capacitors**

C1,C4	0.1 $\mu$ F
C2	10 $\mu$ F tantalum
C3	Not fitted

**Resistors**

R1, R2	10k
R3,R4	1k
R5	4.7k
RP1	10k x 5-way SIL resistor pack

**Semiconductors**

Q3904	2N3904
D1	Green LED
D2 –	Red LED
D5 - D8	BAT41

**Connectors**

J1	2mm x 3-way test socket
J2	36-way Centronics connector
LK1	3-pin Jumper
LK2, LK3, LK4	2-pin Jumper
Misc	
U1	ADM1023
U2	74AC05M Buffers